



METAL WORKING CATALOG

STAND BEHIND YOUR WORK™

550+ SERVICE CENTERS NATIONWIDE

INDUSTRY-LEADING WARRANTIES

EXPERT TECHNICAL SERVICE

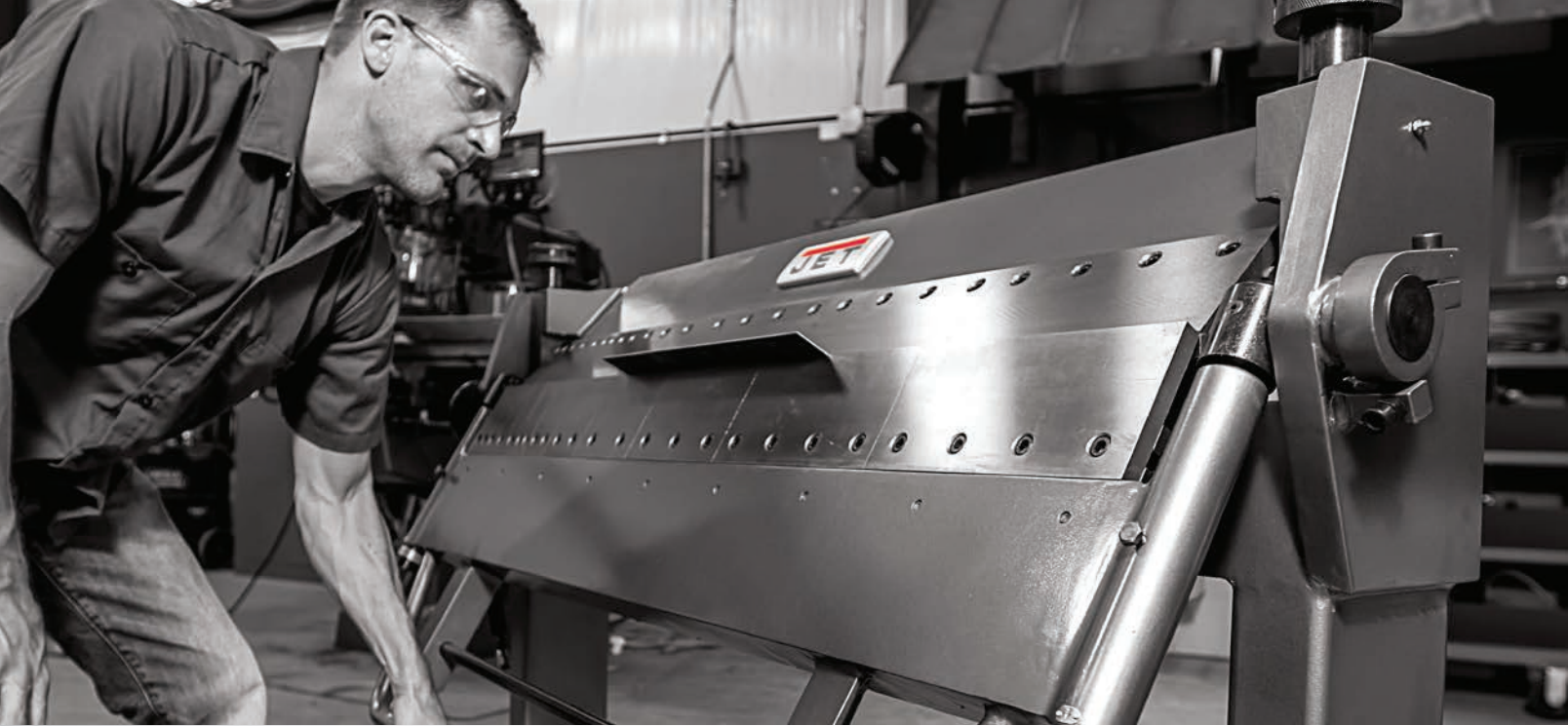

CONTENTS

SAWING

QUICK REFERENCE SAW GUIDE	5
DUAL MITERING HORIZONTAL BANDSAWS	7
HORIZONTAL BANDSAWS	11
PORTABLE DUAL MITERING	15
VERTICAL BANDSAWS	28
COLD SAWS	31
ABRASIVE SAWS	35
ACCESSORIES	36
HELPFUL SAWING INFORMATION	37

TURNING

QUICK REFERENCE LATHE GUIDE	41
HELPFUL TURNING INFORMATION	42
LARGE SPINDLE BORE LATHES	43
GEARED HEAD ENGINE LATHES	49
BELT DRIVE LATHES	51
ACCESSORIES	53
DIGITAL READOUTS	57

MILLING

QUICK REFERENCE GUIDE	61
HELPFUL MILLING INFORMATION	63
CNC VERTICAL MILLS	63
VARIABLE SPEED VERTICAL MILLS	65
EVS VERTICAL MILLS	71
STEP PULLEY MILLS	79
MILL/DRILLS	83
ACCESSORIES	89
DIGITAL READOUTS	93

3

DRILLING

QUICK REFERENCE DRILL GUIDE	97
RADIAL ARM DRILL PRESS	99
DIRECT DRIVE DRILL PRESS	102
GEARED HEAD DRILL PRESS	103
ELECTRONIC VARIABLE SPEED DRILL PRESSES	111
STEP PULLEY DRILL PRESSES	117
INDUSTRIAL BELT DRILL PRESS	120
ACCESSORIES	121
HELPFUL DRILLING INFORMATION	122

95

39

GRINDING & FINISHING

QUICK REFERENCE GUIDE	125
BELT AND DISC MACHINES	127
BELT GRINDERS	131
DISC GRINDERS	135
BENCH GRINDERS AND BUFFERS	137
ACCESSORIES	139
DUST COLLECTION	142
HELPFUL FINISHING INFORMATION	145

123

59

FORMING

QUICK REFERENCE GUIDE	148
SHEARS	151
BRAKES	155
SLIP ROLLS	160
STANDS	163
BENDERS	164
LOCKFORMER	168
NOTCHERS	168
ENGLISH WHEEL	174
PLANISHING HAMMER	175
SHRINKER STRETCHER	176
PRESSES	177
HELPFUL FORMING INFORMATION	179

147





SAWING

Craftsmen who demand excellence rely on JET® saws. Whether on location or in the shop - projects big or small - the finished product is always finer with JET manufactured saws and accessories. Whatever the job requires there is a high-production JET saw that can deliver precision results. Professional user manuals help you put JET saws to work faster, safer and more efficiently. Because JET backs all its machines with the industry's top warranty, you can have confidence that your JET machines will continue providing superior cuts every time you flip the switch. Precision Built and Designed to Last.



CHOOSE YOUR SAW

QUICK REFERENCE GUIDE

STOCK NUMBER	MODEL NUMBER	DESCRIPTION	SAW TYPE	DRIVE TYPE	MOTOR (HP)	MITERING TYPE	MITERING DEGREES	PAGE NUMBER
SEMI-AUTOMATIC HORIZONTAL BANDSAW								
414471	HBS-1321W	13 Semi-Auto Horizontal Bandsaw	Semi-Automatic	Variable Speed Pulley	3 HP, 230/460V, 3Ph	Vise	45°	11
414476	J-7060	12" x 20" Semi-Automatic Horizontal Bandsaw	Semi-Automatic	Variable Speed Pulley	3 HP, 230/460V, 3Ph	Vise	45°	12
414476-4	J-7060-4	12" x 20" Semi-Automatic Horizontal Bandsaw	Semi-Automatic	Variable Speed Pulley	3 HP, 460V, 3Ph	Vise	45°	12
DUAL MITERING BANDSAW								
NEW 413412	MBS-1323EVS-H	13 EVS Dual Miter 3Hp, 23	Horizontal/ Dual-Mitering	Electronic Variable Speed	3Ph, 230V,	Head	45°	10
NEW 413410	MBS-1018-3	10 Dual Miter 2Hp, 230/460V	Horizontal/ Dual-Mitering	Belt Drive	2HP, 230/460V	Vise	45°	13
NEW 413411	MBS-1018-1	10 Dual Miter 2Hp, 230V, 1-P	Horizontal/ Dual-Mitering	Belt Drive	2HP, 230V, 1-P	Vise	45°	13
NEW 424463	HVBS-10 DMW	Dual Portable Saw 1Hp 115V	Horizontal/Vertical/ Dual-Mitering	Belt Drive	1HP, 115V, 1PH	Head	45°	18
NEW 424465	HVBS-10-DMWC	Dual Portable Saw 1 Hp, 115V	Horizontal/Vertical/ Dual-Mitering	Belt Drive	1HP, 115V, 1PH	Head	45°	18
NEW 424460	HVBS-8-DMW	Dual Portable Saw 1 Hp, 115V	Horizontal/Vertical/ Dual-Mitering	Belt Drive	1HP, 115V, 1PH	Head	45°	18
HORIZONTAL MITERING BANDSAWS								
414474	J-7020M	10" x 16" Horizontal Mitering Bandsaw	Horizontal Mitering	Variable Speed Pulley	1-1/2 HP, 115/230V, 1Ph	Head	45°	15
414475	J-7040M	10" x 16" Horizontal Mitering Bandsaw	Horizontal Mitering	Variable Speed Pulley	2 HP, 230/460V, 3Ph	Head	45°	15
414484	J-7040M-4	10" x 16" Horizontal Mitering Bandsaw	Horizontal Mitering	Variable Speed Pulley	2 HP, 460V, 3Ph	Head	45°	15
414477	MBS-1014W-3	10" x 14" Horizontal Mitering Bandsaw	Horizontal Mitering	Belt Drive	3 HP, 230/460V, 3Ph	Head	45°	17
414479	MBS-1014W-1	10" x 14" Horizontal Mitering Bandsaw	Horizontal Mitering	Belt Drive	2 HP, 230V, 1Ph	Head	45°	17
413451	HVBS-710S	7" x 10-1/2" Mitering Horizontal/ Vertical Bandsaw	Horizontal Mitering	Step Pulley	1 HP, 115/230V, 1Ph	Head	45°	26
413452	HVBS-710G	7" x 10-1/2" Mitering Horizontal/ Vertical Geared Head Bandsaw	Horizontal Mitering	Geared Head	1 HP, 115/230V, 1Ph	Head	45°	26
414457	HBS-56S	5" x 6" Horizontal Mitering Bandsaw	Horizontal Mitering	Step Pulley	1/2 HP, 115V, 1Ph	Head	60°	28
ZIP MITER BANDSAWS								
414467	J-9225	8.75" Zip Miter Horizontal Bandsaw	Horizontal Mitering	Geared Head	1-1/2 HP, 230V, 3Ph	Head	60°	21
414464	J-9180-3	7" Zip Miter Horizontal Bandsaw	Horizontal Mitering	Geared Head	1 HP, 230V, 3Ph	Head	60°	21
HORIZONTAL BANDSAWS								
414473	HBS-1018W	10" x 18" Horizontal Bandsaw	Horizontal	Belt Drive	2 HP, 230V, 1Ph	Vise	45°	14
414472	J-7020	10" x 16" Horizontal Bandsaw	Horizontal	Variable Speed Pulley	1-1/2 HP, 115/230V, 1Ph	Vise	45°	16
414478	J-7040	10" x 16" Horizontal Mitering Bandsaw	Horizontal	Variable Speed Pulley	2 HP, 230/460V, 3Ph	Vise	45°	16
414499	J-7040-4	10" x 16" Horizontal Bandsaw	Horizontal	Variable Speed Pulley	2 HP, 460V, 3Ph	Vise	45°	16
414468	HBS-916W	9" x 16" Horizontal Bandsaw	Horizontal	Belt Drive	1-1/2 HP, 115/230V, 1Ph	Vise	45°	20
414450	J-7015	8" x 13" Horizontal Bandsaw	Horizontal	Belt Drive	1-1/2 HP, 115/230V, 1Ph	Vise	45°	23
414466	HBS-814GH	8" x 14" Horizontal Geared Head Bandsaw	Horizontal	Geared Head	1 HP, 115/230V, 1Ph	Vise	45°	22



STOCK NUMBER	MODEL NUMBER	DESCRIPTION	SAW TYPE	DRIVE TYPE	MOTOR (HP)	MITERING TYPE	MITERING DEGREES	PAGE NUMBER
HORIZONTAL/VERTICAL BANDSAW								
413460	HBS-812G	8 x 12" Horizontal/Vertical Geared Head Bandsaw	Horizontal/Vertical	Geared Head	1 HP, 115/230V, 1Ph	Vise	45°	24
414559	HBVS-712	7" x 12" Horizontal/Vertical Bandsaw	Horizontal/Vertical	Step Pulley	3/4HP, 115/230V, 1-Ph	Vise	45°	25
414560	HBVS-712D	7" x 12" Horizontal/Vertical Bandsaw	Horizontal/Vertical	Step Pulley	3/4HP, 115/230V, 1-Ph	Vise	45°	25
NEW 414548	HVBS-56V	5" x 6" Variable Speed Horizontal/Vertical Bandsaw	Horizontal/Vertical	Variable Speed	1/2 HP, 115V	Vise	45°	29
414458	HVBS-56M	5" x 6" Horizontal/Vertical Bandsaw	Horizontal/Vertical	Step Pulley	1/2 HP, 115V, 1Ph	Vise	45°	30
Manual FERROUS COLD SAWS								
414217K	J-FK350-4K	350mm Ferrous Manual Cold Saw	Ferrous	N/A	2 HP, 460V, 3Ph	Head	45° L & R	34
414214K	J-FK350-2K	350mm Ferrous Manual Cold Saw	Ferrous	N/A	2 HP, 230V, 3Ph	Head	45° L & R	34
414227	CS-315	315mm Ferrous Manual Cold Saw	Ferrous	N/A	2 HP, 230V, 3Ph	Head	45° L & R	35
414229	CS-315-1	315mm Ferrous Manual Cold Saw	Ferrous	N/A	2 HP, 220V, 1Ph	Head	45° L & R	35
414226	CS-275	275mm Ferrous Manual Cold Saw	Ferrous	N/A	1-1/2 HP, 230V, 3Ph	Head	45° L & R	35
414228	CS-275-1	275mm Ferrous Manual Cold Saw	Ferrous	N/A	1-1/2 HP, 115V, 1Ph	Head	45° L & R	35
414220	J-F225	225mm Ferrous Manual Bench Cold Saw	Ferrous	N/A	1 HP, 115V, 1Ph	Head	45° L	37
HIGH SPEED NON-FERROUS COLD SAWS								
414207K	J-CK350-4K	350mm Non-Ferrous High Speed Manual Cold Saw	Non-Ferrous	N/A	2 HP, 460V, 3Ph	Head	45° L & R	36
414203K	J-CK350-2K	350mm Non-Ferrous High Speed Manual Cold Saw	Non-Ferrous	N/A	2 HP, 230V, 3Ph	Head	45° L & R	36
ABRASIVE SAWS								
NEW 414240	AB-12	Abrasive Saw 3PH 230V	Abrasive	N/A	5HP, 230V/460V, 3Ph	Head	45° L & R	38
NEW 414245	AB-14	Abrasive Saw 3PH 230V	Abrasive	N/A	5HP, 230V/460V, 3Ph	Head	45° L & R	38
VERTICAL BANDSAWS								
414470	VBS-3612	36" Vertical Bandsaw	Vertical	Variable Speed Pulley	3 HP, 230/460V, 3Ph	Table	10° L & 45° R	31
414482	VBS-2012	20" Vertical Bandsaw	Vertical	Variable Speed Pulley	2 HP, 230/460V, 3Ph	Table	8° F & B, 12° L & 15° R	31
414485	VBS-1610	16" Vertical Bandsaw	Vertical	Variable Speed Pulley	2 HP, 230/460V, 3Ph	Table	8° F & B, 12° L & 15° R	31
414483	VBS-1408	14" Vertical Bandsaw	Vertical	Variable Speed Pulley	1 HP, 115/230V, 1Ph	Table	8° F & B, 12° L & 15° R	31
VERTICAL METAL/WOOD BANDSAW								
414418	VBS-18MW	18" Metal/Wood Vertical Bandsaw	Metal/Wood Vertical	Step Pulley	3/4 HP, 115/230V, 1Ph	Table	15° L & 45° R	32
414500	J-8201K	14" Metal/Wood Vertical Bandsaw	Metal/Wood Vertical	Step Pulley	1 HP, 115/230V, 1Ph	Table	15° L & 45° R	33
414504C	J-8203K	14" Metal/Wood Vertical Bandsaw	Metal/Wood Vertical	Step Pulley	1 HP, 230/460V, 3Ph	Table	15° L & 45° R	33
414502	J-8201VS	14" Metal/Wood Vertical Variable Speed Bandsaw	Metal/Wood Vertical	Variable Speed Pulley	1 HP, 115/230V, 1Ph	Table	15° L & 45° R	33

NEW

SEMI-AUTOMATIC DUAL MITERING EVS BANDSAW



SHOWN WITH
OPTIONAL STAND

DURABILITY

- Heavy-duty construction reduces vibration and deflection
- Built in, self-propelled blade brush prevents chip build up in blade guides
- Coolant is distributed through the blade guides
- Blade tension gauge helps to ensure the blade is in the correct cutting position

SAFETY

- Magnetic starter for low voltage and lost phase protection
- Automatic blade breakage sensor detects accidental breakage and interrupts the power
- Power switch with safety key prevents accidental start up
- CSA/CUS: Following strict guidelines and electrical requirements, this JET saw is CSA/CUS certified
- Blade is fully guarded for operator safety
- Automatic shut off switch stops the sawing process

EASE OF USE

- Equipped with frequency inverter which allows this EVS saw full range of blade speeds
- Semi-Automatic bow raises after cut to predetermined height
- Hydraulic downfeed control is easily adjusted enabling feed rates to evolve with variable types of materials
- Integrated pressurized wash hose for easy machine clean up
- Hydraulic Vise for rapid clamping of material on 13" saw
- Adjustable material stop

STOCK NUMBER	413412
Model Number	MBS-1323EVS-H
CUTTING CAPACITIES	
Tubing Round at 90 Degrees (in.)	13
Tubing Round at 60 Degrees (in.)	11
Tubing Round at 45 Degrees (in.)	13
Tubing Square at 90 Degrees (in.)	13
Tubing Square at 60 Degrees (in.)	11
Tubing Square at 45 Degrees (in.)	13
Tubing Rectangle at 90 Degrees (in.)	12 x 23-1/2
Tubing Rectangle at 60 Degrees (in.)	7 x 12
Tubing Rectangle at 45 Degrees (in.)	8 x 16
Solid Round at 90 Degrees (in.)	13
Solid Round at 60 Degrees (in.)	11
Solid Round at 45 Degrees (in.)	13
Solid Square at 90 Degrees (in.)	13
Solid Square at 60 Degrees (in.)	11
Solid Square at 45 Degrees (in.)	13
Solid Rectangle at 90 Degrees (in.)	12 x 23-1/2
Solid Rectangle at 60 Degrees (in.)	7 x 12
Solid Rectangle at 45 Degrees (in.)	8 x 16
Head Movement (deg.)	45R, 60L
Maximum Vise Opening (in.)	26
Blade Speeds (sfpm) (Electronic Variable Speed)	Variable 50 - 297
Blade Wheel Diameter (in.)	16
Blade Size (in.)	1-1/4 x 0.043 x 172
Bed Height (in.)	27 3/4
Motor (HP)	3 HP, 230/460V, 3-Phase
Motor Prewired	230V, 3Ph
Overall Dimensions (L x W x H / in.)	88 x 55 x 51 (machine)
Net Weight (lbs.)	1826
Gross Weight (lbs.)	2090

OPTIONAL EQUIPMENT	PART NUMBER
Replacement Blade - 1-1/4 x 0.043 x 172 4/6T	414403
Roller Stand	413413



13" SEMI-AUTO HORIZONTAL BANDSAW



DURABILITY

- Large handwheel and built-in gauge provides easy blade tensioning
- Coolant is distributed through the blade guides
- Self-propelled blade brush extends the blade life

SAFETY

- Safety switch shuts off motor if band breaks
- Automatic shut-off after cutach

EASE OF USE

- Semi-automatic bow raises after cut is complete to predetermined height
- Fully adjustable hydraulic downfeed controls the rate of descent
- Quick-positioning vise lessens set-up time
- Cleaning hose and nozzle assist in washing chips away
- Easy access chip tray allows quick cleanup
- Variable blade speed allows optimum cutting performance
- Adjustable material stop

STANDARD EQUIPMENT

- 1-1/4VT Bi-Metal

STOCK NUMBER	414471
Model Number	HBS-1321W
CUTTING CAPACITIES	
Round Capacity at 90° (in.)	13
Round Capacity at 45° (in.)	10-1/2
Rectangle Capacity at 90° (in.)	10 x 21 and 13 x 19
Rectangle Capacity at 45° (in.)	11-1/2 x 10-1/2
Blade Size (in.)	1-1/4 x .042 x 161-1/2
Blade Wheel Diameter (in.)	18
Blade Speed (sfpm)	80 - 260
Bed Height (in.)	28-3/4
Motor (HP)	3HP, 230/460V, 3Ph, Prewired 230V
Floor Space Required (L x W x H / in.)	87 x 32 x 55
Net Weight (lbs.)	1,276



12" x 20" SEMI-AUTOMATIC HORIZONTAL BANDSAWS

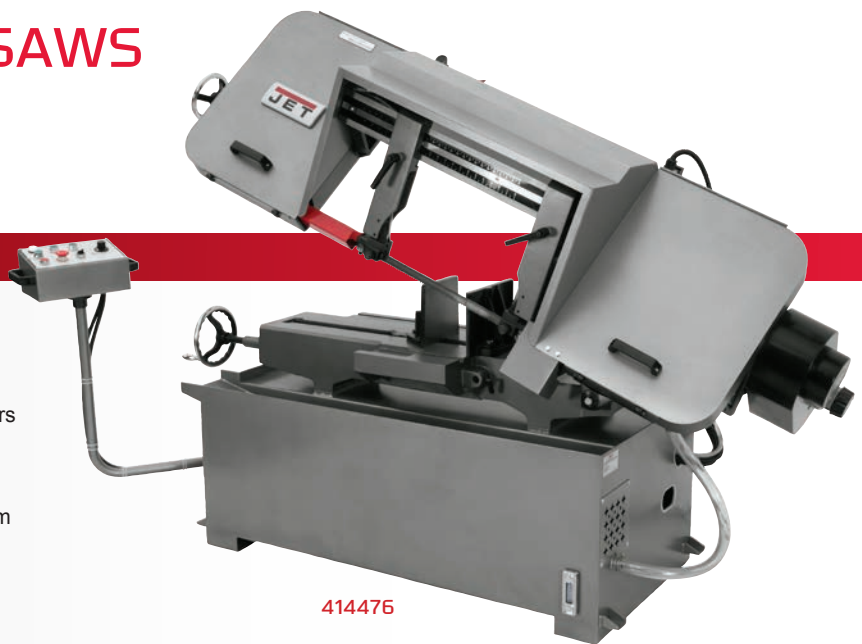

DURABILITY

- Heavy-duty transmission utilizes hardened and ground gears operating in an oil bath
- Cast iron band wheels
- Counterbalanced feed system is controlled by a dual system of counterbalance springs working with a hydraulic cylinder

SAFETY

- Saw head raised hydraulically after each cut

EASE OF USE

- Swivel control panel puts sawing functions at operators fingertips
- Variable speed drive system allows the operator to fine tune the blade speed fast and easily
- Exclusively patented 3 jaw vise allows for faster set up
- Exclusive six contact point blade adjustable guide assemblies utilize cam follower bearings mounted on eccentric shafts on both sides of the blade

STANDARD EQUIPMENT

- Coolant system
- 1" Bi-metal blade
- Adjustable material stop

STOCK NUMBER	414476	414476-4
Model Number	J-7060	J-7060-4
CUTTING CAPACITIES		
Round Capacity at 90° (in.)	12	12
Round Capacity at 45° (in.)	12	12
Rectangle Capacity at 90° (in.)	12 x 20	12 x 20
Rectangle Capacity at 45° (in.)	12 x 12	12 x 12
Blade Size (in.)	1 x .035 x 156	1 x .035 x 156
Blade Wheel Diameter (in.)	17	17
Blade Speed (sfpm)	82 - 262	82 - 262
Bed Height (in.)	26-1/4	26-1/4
Motor (HP)	3HP, 230/460V, 3Ph, Prewired 230V	3 HP, 460V, 3Ph
Floor Space Required (L x W x H / in.)	87 x 37-1/2 x 53	87 x 37-1/2 x 53
Net Weight (lbs.)	1144	1144

OPTIONAL EQUIPMENT	STOCK NUMBER
Replacement Blade - 1" x .035" x 156" x 4/6VT	5512107
Replacement Blade - 1" x .035" x 156" x 5/8VT	5674023
Replacement Blade - 1" x .035" x 156" x 6/10VT	5512108



NEW

10" x 18" DUAL MITERING BANDSAW



413411

DURABILITY

- Heavy-duty construction reduces vibration and deflection
- Built in, self-propelled blade brush prevents chip build up in blade guides
- Coolant is distributed through the blade guides
- Blade tension gauge helps to ensure the blade is in the correct cutting position

SAFETY

- Magnetic starter for low voltage and lost phase protection
- Automatic blade breakage sensor detects accidental breakage and interrupts the power
- Power switch with safety key prevents accidental start up
- CSA/CUS: Following strict guidelines and electrical requirements, this JET saw is CSA/CUS certified
- Blade is fully guarded for operator safety
- Automatic shut off switch stops the sawing process

EASE OF USE

- Equipped with Frequency Inverter which allows this EVS saw full range of blade speeds
- Semi-Automatic bow raises after cut to predetermined height
- Hydraulic downfeed control is easily adjusted enabling feed rates to evolve with variable types of materials
- Integrated pressurized wash hose for easy machine clean up
- Quick action vise

STOCK NUMBER	413411	413410
Model Number	MBS-1018-1	MBS-1018-3
CUTTING CAPACITIES		
Tubing Round at 90 Degrees (in.)	10	10
Tubing Round at 60 Degrees (in.)	6	6
Tubing Round at 45 Degrees (in.)	10	10
Tubing Square at 90 Degrees (in.)	10	10
Tubing Square at 60 Degrees (in.)	5-1/2	5-1/2
Tubing Square at 45 Degrees (in.)	10	10
Tubing Rectangle at 90 Degrees (in.)	10 x 17	10 x 17
Tubing Rectangle at 60 Degrees (in.)	6 x 5	6 x 5
Tubing Rectangle at 45 Degrees (in.)	10 x 12	10 x 12
Solid Round at 90 Degrees (in.)	10	10
Solid Round at 60 Degrees (in.)	6	6
Solid Round at 45 Degrees (in.)	10	10
Solid Square at 90 Degrees (in.)	10	10
Solid Square at 60 Degrees (in.)	5-1/2	5-1/2
Solid Square at 45 Degrees (in.)	10	10
Solid Rectangle at 90 Degrees (in.)	10 x 17	10 x 17
Solid Rectangle at 60 Degrees (in.)	6 x 5	6 x 5
Solid Rectangle at 45 Degrees (in.)	10 x 12	10 x 12
Head Movement (deg.)	45R, 60L	45R, 60L
Maximum Vise Opening (in.)	18	18
Blade Speeds (sfpm)	50, 125, 200, 275	50, 125, 200, 275
Blade Wheel Diameter (in.)	14-1/4	14-1/4
Blade Size (in.)	1 x 0.032 x 144	1 x 0.032 x 144
Bed Height (in.)	22-1/2	22-1/2
Motor (HP)	2 HP, 230V, 1 Phase	2 HP, 230/460V, 3 Phase
Motor Prewired		230V, 3Ph
Overall Dimensions (L x W x H / in.)	79 x 36 x 46	79 x 36 x 46
Net Weight (lbs.)	1034	1034
Gross Weight (lbs.)	1144	1144

OPTIONAL EQUIPMENT	BLADE REPLACEMENT PART NUMBER
Replacement Blade - 1 x 0.032 x 144 4/6T	891097



10" x 18" HORIZONTAL BANDSAW



DURABILITY

- Heavy-duty casted body
- Coolant is distributed through the blade guides
- Carbide Blade guides feature parallel double-row ball bearing support
- 4/6VT Bi-metal blade

SAFETY

- Blade is guarded regardless of blade guide position
- Automatic shut-off after cut

EASE OF USE

- Removable chip tray for quick clean-up
- Large hand wheel and built-in gauge for easy blade tensioning
- Built-in, self propelled blade brush extends blade life
- Quick-positioning vise with fully adjustable jaws swivels to 45°
- Fully adjustable hydraulic downfeed with separate on/off valve
- Adjustable material stop

STOCK NUMBER		414473
Model Number	HBS-1018W	
CUTTING CAPACITIES		
Round Capacity at 90° (in.)	10	
Round Capacity at 45° (in.)	7-1/2	
Rectangle Capacity at 90° (in.)	10 x 16 and 6-1/2 x 18	
Rectangle Capacity at 45° (in.)	10 x 7-1/2	
Vise Swivels (deg.)	45°	
Blade Size (in.)	1 x 0.032 x 130	
Blade Wheel Diameter (in.)	14	
Blade Speed (sfpm)	82, 132, 210, 330	
Bed Height (in.)	23-1/2	
Motor (HP)	2HP, 230V only, 1Ph	
Floor Space Required (L x W x H / in.)	69 x 28 x 42-3/4	
Net Weight (lbs.)	776	

OPTIONAL EQUIPMENT	STOCK NUMBER
Replacement Blade - 1" x .035" x 130-1/2" x 4/6VT	414308
Replacement Blade - 1" x .035" x 130-1/2" x 8/12VT	414310



10" x 16" HORIZONTAL MITERING BANDSAWS



414474

DURABILITY

- Heavy-duty transmission utilizes hardened and ground gears operating in an oil bath
- Combined with the side bearings are carbide pads, the back of the blade rides on two load bearings mounted on a pivot shaft so both bearings share the load equally
- Cast iron blade wheels
- 1" Bi-metal blade

SAFETY

- Blade guard
- Counterbalanced feed system is controlled by a dual system of counterbalance springs working with a hydraulic cylinder

EASE OF USE

- Variable speed drive system allows the operator to fine tune the blade speed fast and easily
- Exclusive six contact point blade adjustable guide assemblies
- Mitering head – the workpiece remains fixed while the head swivels to cut any angle 0° - 45°
- Swing away control panel houses major saw controls
- Adjustable material stop

STOCK NUMBER	414474	414475	414484
Model Number	J-7020M	J-7040M	J-7040M-4
CUTTING CAPACITIES			
Round Capacity at 90° (in.)	10	10	10
Round Capacity at 45° (in.)	10	8-1/2	8-1/2
Rectangle Capacity at 90° (in.)	2 x 16 and 10 x 14	2 x 16 and 10 x 14	2 x 16 and 10 x 14
Rectangle Capacity at 45° (in.)	8-1/2 x 9	8-1/2 x 9	8-1/2 x 9
Vise Swivels (deg.)	45	45	45
Blade Size (in.)	1 x .035 x 135	1 x .035 x 135	1 x .035 x 135
Blade Wheel Diameter (in.)	14	14	14
Blade Speed (sfpm)	100-350	100 - 350	100 - 350
Bed Height (in.)	25-1/2	25-1/2	25-1/2
Motor (HP)	1-1/2HP, 115/230V, 1Ph, Prewired 230V	2HP, 230 3Ph, Prewired 230V	2HP, 460V, 3Ph, Prewired 460V
Floor Space Required (L x W x H / in.)	76 x 30 x 48	76 x 30 x 48	76 x 30 x 48
Net Weight (lbs.)	794	794	794



10" x 16" HORIZONTAL BANDSAW



DURABILITY

- Heavy-duty rugged transmission utilizes hardened and ground gears operating in an oil bath
- One piece wheel cover
- Cast iron blade wheels
- Bi-Metal Blade

SAFETY

- Exclusive adjustable blade guide with six contact point system that utilizes cam follower bearings mounted on eccentric shafts on both sides of the blades

EASE OF USE

- Swivel control panel puts sawing functions at operator's fingertips
- Variable speed drive system allows the operator to fine tune the blade speed fast and easily
- Patented 3-Jaw vise with rapid action moveable jaw for faster set up
- Adjustable material stop
- Large one piece wheel cover
- Coolant system

STOCK NUMBER	414472	414478	414499
Model Number	J-7020	J-7040	J-7040-4
CUTTING CAPACITIES			
Round Capacity at 90° (in.)	10	10	10
Round Capacity at 45° (in.)	10	10	10
Rectangle Capacity at 90° (in.)	7 x 16 / 10 x 10	7 x 16 / 10 x 10	7 x 16 / 10 x 10
Rectangle Capacity at 45° (in.)	6-1/2 x 11	6-1/2 x 11	6-1/2 x 11
Blade Size (in.)	1 x .035 x 130	1 x .035 x 130	1 x .035 x 130
Blade Wheel Diameter (in.)	14	14	14
Blade Speed (sfpm)	100 - 350	100 - 350	100 - 350
Bed Height (in.)	23-1/2	23-1/2	23-1/2
Motor (HP)	1-1/2HP, 115/230V, 1Ph, Prewired 230V	2HP, 230V, 3Ph	2HP, 460V, 3Ph, Prewired 460V
Floor Space Required (L x W x H / in.)	75-1/2 x 33 x 41	75-1/2 x 33 x 41	75-1/2 x 33 x 41
Net Weight (lbs.)	927	927	927

OPTIONAL EQUIPMENT	STOCK NUMBER
Replacement Blade - 1" x .035" x 135" x 4/6VT	5674011
Replacement Blade - 1" x .035" x 135" x 5/8VT	5674022
Replacement Blade - 1" x .035" x 135" x 6/10VT	5674021



10" x 14" HORIZONTAL MITERING BANDSAWS



414477

DURABILITY

- Mitering head swivels to cut any angle 0° - 45° while the work piece remains secured
- Built-in, self-propelled blade brush extends blade life
- Coolant system
- Coolant is distributed through the blade guides
- 4/6VT Bi-metal blade

SAFETY

- Automatic shut-off after cut

EASE OF USE

- Large, easy-to-read scale for accurate positioning of the saw head
- Fully adjustable hydraulic downfeed with separate on/off control valve
- Large handwheel and built-in gauge provides easy blade tensioning
- Carbide blade guides with roller bearings
- Quick positioning vise reduces set-up time
- Adjustable material stop

STOCK NUMBER	414479	414477
Model Number	MBS-1014W-1	MBS-1014W-3
CUTTING CAPACITIES		
Round Capacity at 90° (in.)	10	10
Round Capacity at 45° (in.)	9	9
Rectangle Capacity at 90° (in.)	10 x 14	10 x 14
Rectangle Capacity at 45° (in.)	9 x 8-1/2	9 x 8-1/2
Vise Swivels (deg.)	45	45
Blade Size (in.)	1 x .035 x 130, 4/6VT	1 x .035 x 130, 4/6VT
Blade Wheel Diameter (in.)	14	14
Blade Speed (sfpm)	82, 132, 210, 330	82,132,210,330
Bed Height (in.)	25	25
Motor (HP)	2HP, 230V Only, 1Ph	3 HP, 230/460V, 3Ph Prewired 230V
Floor Space Required (L x W x H / in.)	26x69x44	26 x 69 x 44
Net Weight (lbs.)	948	948

OPTIONAL EQUIPMENT	STOCK NUMBER
Replacement Blade - 1" x .035" x 130" x 4/6VT	414311



NEW

8" AND 10" PORTABLE DUAL MITERING BANDSAWS

DURABILITY

- Built in, self-propelled blade brush prevents chip build up in blade guides
- Pipe Jaws included with vise
- Coolant system available on #424465 10" Saw

SAFETY

- Power switch with safety key prevents accidental start up
- CSA/CUS: Following strict guidelines and electrical requirements, these JET saws are CSA/CUS certified
- Blade is fully guarded for operator safety and can be used in both vertical & horizontal cutting positions
- Automatic shut off switch stops the sawing process

EASE OF USE

- Hydraulic downfeed control is easily adjusted enabling feed rates to evolve with variable types of materials
- Head dual miters both left & right for quick angle cuts
- Protractor for fast and accurate angle cutting
- Converts from horizontal to vertical position with ease
- Large 16" x 10" Vertical cutting table comes standard
- Locking front casters to guide saw across the floor
- Back wheels standard for ease of movement on any shop floor



STOCK NUMBER	424460	424463	424465
Model Number	HVBS-8-DMW	HVBS-10-DMW	HVBS-10-DMWC
CUTTING CAPACITIES			
Tubing Round at 90 Degrees (in.)	8	10	10
Tubing Round at 45 Degrees (in.)	6	6-1/2	6-1/2
Tubing Square at 90 Degrees (in.)	7	8	8
Pipe Square at 45 Degrees (in.)	5-1/2	5-1/2	5-1/2
Pipe Rectangle at 90 Degrees (in.)	7 x 8	8 x 9	8 x 9
Pipe Rectangle at 45 Degrees (in.)	7 x 5-1/2	8 x 5-1/2	8 x 5-1/2
Solid Round at 90 Degrees (in.)	8	10	10
Solid Round at 45 Degrees (in.)	6	6-1/2	6-1/2
Solid Square at 90 Degrees (in.)	7	8	8
Solid Square at 45 Degrees (in.)	5-1/2	5-1/2	5-1/2
Solid Rectangle at 90 Degrees (in.)	7 x 8	8 x 9	8 x 9
Solid Rectangle at 45 Degrees (in.)	7 x 5-1/2	8 x 5-1/2	8 x 5-1/2
Vertical Cutting Capacity (in.)	12 x 8	13 x 10	13 x 10
Head Movement (deg.)	+/- 45	+/- 45	+/- 45
Maximum Vise Opening (in.)	8.25	10	10
Blade Speeds (sfpm)	64, 132, 247	64, 132, 247	64, 132, 247
Blade Wheel Diameter (in.)	8-13/16	11 23/32	11 23/32
Blade Size (in.)	1 x 0.035 x 102.9	1 x 0.035 x 120	1 x 0.035 x 120
Table Height (in.)	27-5/16	30-13/32	30-13/32
Coolant Pump Motor (HP)	N/A	N/A	1/8HP, 115V, Single Phase
Electrics (HP)	3/4HP, 115V, Single Phase	1HP, 115V, Single Phase	1HP, 115V, Single Phase
Overall Dimensions (L x W x H / in.)	24 x 54.7 x 43.8	72 x 34.5 x 46	72 x 34.5 x 46
Net Weight (lbs.)	363	528	528
Gross Weight (lbs.)	500	558	558

OPTIONAL EQUIPMENT	STOCK NUMBER
Replacement Blade - 3/4" x 0.035" x 103" 5/8T for 424460	HVBS-8-DMW-6
Replacement Blade - 1" x 0.035" x 120" 5/8T for 424463 & 424465	HVBS10-DMW-6

9" x 16" HORIZONTAL BANDSAW



DURABILITY

- Blade guides feature parallel double row ball bearing support
- Coolant is distributed through the blade guides
- 4/6VT Bi-metal blade

SAFETY

- Blade is fully guarded regardless of blade guide position
- Automatic shut-off after cut
- Blade brush is built-in and self-propelled
- Fully adjustable hydraulic downfeed with separate on/off valve

EASE OF USE

- Large handwheel and built-in gauge for easy blade tensioning
- Quick-positioning vise with fully adjustable jaws swivels to 45°
- Removable chip tray for quick clean-up

STOCK NUMBER	414468
Model Number	HBS-916W
CUTTING CAPACITIES	
Round Capacity at 90° (in.)	9
Round Capacity at 45° (in.)	6-1/8
Rectangle Capacity at 90° (in.)	2 x 16 and 8-1/2 x 14
Rectangle Capacity at 45° (in.)	9 x 6-1/8
Vise Swivels (deg.)	45
Blade Size (in.)	1 x .035 x 119-1/2
Blade Wheel Diameter (in.)	13
Blade Speed (sfpm)	82, 132, 170, 235
Bed Height (in.)	25
Motor (HP)	1-1/2HP, 115/230V, 1Ph, Prewired 115V
Floor Space Required (L x W x H / in.)	65 x 28 x 42
Net Weight (lbs.)	625



7" AND 8-3/4" ZIP MITER HORIZONTAL BANDSAWS



414464

DURABILITY

- Complete coolant system
- Coolant is distributed through the blade guides
- Heavy-duty cast iron saw head and sturdy base
- Eccentric shaft ball bearings
- Bi-Metal bandsaw blade

SAFETY

- Overload protection
- Quick Release vise

EASE OF USE

- Adjustable hydraulic feed system
- Mitering capability to 60°
- Convenient control panel
- Hydraulic blade tension gauge
- Adjustable material stop

STOCK NUMBER	414464	414467
Model Number	J-9180-3	J-9225
CUTTING CAPACITIES		
Round Capacity at 90° (in.)	7	8-3/4
Round Capacity at 45° (in.)	4-1/2	6-1/4
Rectangle Capacity at 90° (in.)	7 x 7	8-3/4 x 7
Rectangle Capacity at 45° (in.)	4-1/2 x 4-1/2	6-1/4 x 7-1/4
Vise Swivels (deg.)	60	60
Blade Size (in.)	3/4 x .035 x 82	1 x .035 x 96-1/2
Blade Speed (sfpm)	137, 275	157, 314
Blade Wheel Diameter (in.)	10-1/2	11-5/8
Bed Height (in.)	35-7/8	38-7/16
Motor (HP)	1HP, 230V, 3Ph	1-1/2HP, 230V, 3Ph
Floor Space Required (L x W x H / in.)	47 x 29 x 56-1/2	51 x 33 x 59-1/4
Net Weight (lbs.)	375	485



8" x 14" HORIZONTAL GEARED HEAD BANDSAW



DURABILITY

- Heavy-duty geared head transmission for quick speed changes
- Hardened and ground worm gears
- 3/4" Bi-metal blade

SAFETY

- Blade guard

EASE OF USE

- Hydraulic feed
- Easy accessible control panel for operator use
- Portable on wheels
- Miters at 45°
- Quick action vise
- Coolant system
- Adjustable material stop
- Chip brush

STOCK NUMBER	414466
Model Number	HBS-814GH
CUTTING CAPACITIES	
Round Capacity at 90° (in.)	8
Round Capacity at 45° (in.)	6-1/2
Rectangle Capacity at 90° (in.)	14 x 8 ; 2 x 14
Rectangle Capacity at 45° (in.)	6-1/2 (H) x 6 (W) & 2 (H) x 7 (W)
Throat Depth (in.)	8
Vise Swivels (deg.)	45
Blade Size (in.)	3/4 x .035 x 97
Blade Wheel Diameter (in.)	12
Blade Speed (sfpm)	135, 197, 256
Bed Height (in.)	26
Motor (HP)	1HP, 115/230V, 1Ph, Prewired 115V
Floor Space Required (L x W x H / in.)	51-1/2 x 18-1/8 x 44
Net Weight (lbs.)	287

OPTIONAL EQUIPMENT	STOCK NUMBER
Replacement Blade - 3/4" x .035" x 97" x 8R-C	5674032
Replacement Blade - 3/4" x .035" x 97" x 5/8VT	5674033
Replacement Blade - 3/4" x .035" x 97" x 8/12VT	5674034



8" x 13" HORIZONTAL BANDSAW



DURABILITY

- The combination of an oil bath, gear reduction power train, along with precision blade guides and a hydraulic feed system delivers consistent, accurate cuts.
- Longer blade wheel base reduces blade fatigue and increases blade life
- Heavy-duty, rigid steel and cast iron construction of the head and base provides full blade support and eliminates vibration and deflection.
- 1" Bi-metal blade

SAFETY

- Dual voltage electrics (115V/230V) with overload and low voltage protection
- Blade guard

EASE OF USE

- Conveniently located control panel and an easily accessible coolant system
- Easy-to-use belt drive tensioner does not require tools for blade speed changes or belt replacement
- Rapid acting vise (allows miter cutting to 45°)
- Coolant system
- Adjustable material stop

STOCK NUMBER	414450
Model Number	J-7015
CUTTING CAPACITIES	
Round Capacity at 90° (in.)	9
Round Capacity at 45° (in.)	9
Rectangle Capacity at 90° (in.)	9 x 13
Rectangle Capacity at 45° (in.)	9 x 8
Blade Size (in.)	1 x .035 x 114.5
Blade Wheel Diameter (in.)	11-5/8
Blade Speed (sfpm)	82, 132, 170, 235
Bed Height (in.)	27-1/2
Motor (HP)	1.5HP, 115/230V, 1Ph, Prewired 115V
Floor Space Required (L x W x H / in.)	62-1/2 x 23 x 48
Net Weight (lbs.)	551

OPTIONAL EQUIPMENT	STOCK NUMBER
Replacement Blade - 1" x .035" x 114-1/2" x 4/6VT	5516191
Replacement Blade - 1" x .035" x 114-1/2" x 8/12VT	5516193



8" x 12" HORIZONTAL / VERTICAL GEARED HEAD BANDSAW



DURABILITY

- UL Listed motor
- Heavy cast iron bow & head
- Hardened and ground worm gear
- Bi-metal blade

SAFETY

- Blade guard

EASE OF USE

- Gear box for ease of speed change
- Large 8" wheels and handle for easy movement in your shop
- Coolant system included
- Quick Lock Vise
- Vertical Worktable
- Adjustable work stop
- Chip Brush

STOCK NUMBER	413460
Model Number	HBS-812G
CUTTING CAPACITIES	
Round at 90° (in.)	8
Round at 45° (in.)	5
Rectangle at 90° (in.)	8 x 11-1/4
Rectangle at 45° (in.)	5 x 8
Vise Swivels	45°
Blade Size (in.)	3/4" x .035 x 93
Blade Speeds (sfpm)	145, 208, 255
Height (in.)	43
Motor (HP)	1HP, 115/230V, 1Ph, Prewired 115V
Net Weight (lbs.)	308



7" x 12" HORIZONTAL / VERTICAL INDUSTRIAL BANDSAWS



DURABILITY

- Blade drive is a belt to sealed, hardened and ground gear drive system
- Heavy cast iron bow and bed
- Improved wider stand with built-in storage cabinet and chip tray
- Blade wheels are made flanged cast iron
- Bi-metal 5/8T blade

SAFETY

- CSA/CUS: CSA/CUS: Following strict guidelines and electrical requirements, these JET saws are CSA/CUS certified
- UL listed switches
- Blade tensioning guides
- Auto shut-off after cut
- Cast mounted hydraulic downfeed for ease of cut

EASE OF USE

- Four 8" rubber wheels for ease of movement
- Quick change vise, miters to 45° (414559)
- Toolless quick lock vise with preset mitering positions at 15°, 30° & 45° (414560)
- Multi-position blade guide enhances use in vertical position by increases the throat capacity from 4" to 8" and creates a safer working position (414560)
- Side-eccentric shaft with ball bearings and rear-ball bearing blade guides (414559)
- Adjustable hydraulic downfeed system
- Large 10" x 12" infeed table assembly extends the support area and can be used in either horizontal or vertical positions (414560)
- Micro adjustable toolless material stop (414560)
- Coolant pump with 1 gallon tank, 1/8HP, single phase motor complete with hose, flexible nozzle, shut-off valve, tank and baffle
- Chip brush



STOCK NUMBER	414559	414560
Model Number	HVBS-712	HVBS-712D
Cutting Capacity (W x D) (in.)	7 x 12	7 x 12
Round Capacity at 90 Degree (in.)	7	7
Round Capacity at 45 Degree (in.)	4-1/2	5
Rectangle Capacity at 90 Degree (in.)	1 (H) x 12 (W) 2 (H) x 11-1/4(W) 4 (H) x 11 (W) 7 (H) x 10-3/8 (W)	1 (H) x 12 (W) 2 (H) x 11-1/4 (W) 4 (W) x 11 (W) 7 (H) x 10-1/4 (W)
Rectangle Capacity at 45 Degree (in.)	6-1/2 (H) x 4-1/2 (W)	6 (H) x 4 (W)
Square Capacity at 90 Degree (in.)	7 x 7	7 x 7
Square Capacity at 45 Degree (in.)	4-1/2 x 4-1/2	5 x 5
Throat Depth (in.)	7	7
Vertical Tables (in.)	5 x 6	10 x 12
Vise Swivels (deg.)	45	45
Blade Size (in.)	3/4 x .032 x 93	3/4 x .032 x 93
Blade Wheel Diameter (in.)	11-3/4	11-3/4
Blade Speed (sfpm)	86, 132, 178, 260	86, 132, 178, 260
Bed Height (in.) with out Wheels	22-1/4	22-1/4
Motor/Electrics (HP)	3/4HP, 115/230V, 1-Ph	3/4HP, 115/230V, 1-Ph
Prewired	115V	115V
Overall Dimensions (L x W x H / in.)	48 x 17 x 40	48 x 17 x 44
Net Weight (lbs.)	374	374

OPTIONAL EQUIPMENT	STOCK NUMBER
Replacement Blade - 3/4" x .035" x 93" x 6/10VT	414304

7" x 10-1/2" HORIZONTAL / VERTICAL MITERING BANDSAW

DURABILITY

- Heavy cast iron bow and head
- Hardened and ground worm gear
- 3/4" Bi-metal blade 5/8 TPI

SAFETY

- Blade guard

EASE OF USE

- Swivel head for both horizontal and vertical miter cutting
- Hydraulic downfeed for ease of cut
- Large 8" wheels and handle for easy movement in your shop
- Quick lock vise
- Coolant system
- Adjustable material stop
- Chip brush



413451

STOCK NUMBER	413451	413452
Model Number	HVBS-710S	HVBS-710G
Motor Drive	Belt	Geared
CUTTING CAPACITIES		
Round at 90° (in.)	7	7
Round at 45° (in.)	4	4
Rectangle at 90° (in.)	7 x 10-1/2	7 x 10-1/2
Rectangle at 30° (in.)	4-3/4 x 4	4-3/4 x 4
Blade Size (in.)	3/4" x .032 x 93 5/8 TPI	3/4 x .032 x 93 5/8 TPI
Blade Speeds (sfpm)	86, 131, 182, 260	145, 208, 255
Blade Wheel Diameter (in.)	11-3/4	11-3/4
Motor (HP)	1HP, 115/230V, 1Ph Prewired 115V	1 HP, 115/230V, 1Ph Prewired 115V
Net Weight (lbs.)	396	396

OPTIONAL EQUIPMENT	STOCK NUMBER
Replacement Blade - 3/4" x .035" x 93" x 6R	5632142
Replacement Blade - 3/4" x .035" x 93" x 14R	5632161



5" x 8" HORIZONTAL BANDSAW



DURABILITY

- Heat treated steel worm gear and bronze drive gear
- Eccentric shaft and ball bearing side blade guides
- Ball bearing rear blade guides

SAFETY

- Automatic shut off at end of cut
- Adjustable hydraulic feed system
- Blade guard

EASE OF USE

- Adjustable ball bearing guides
- Handle and wheels for convenient moving to various work stations
- 1 gallon capacity coolant system, 115V/1Ph, complete with hose, flexible nozzle, shut off valve, tank and baffle
- 1/2" carbon steel blade

STOCK NUMBER	414453
Model Number	J-3230
CUTTING CAPACITIES	
Round Capacity at 90° (in.)	5
Round Capacity at 45° (in.)	4-1/2
Rectangle Capacity at 90° (in.)	7-1/2 x 5
Rectangle Capacity at 45° (in.)	4-1/2 x 5
Blade Size (in.)	1/2 x .025 x 68
Blade Wheel Diameter (in.)	7-1/2
Blade Speed (sfpm)	85, 125, 200
Bed Height (in.)	23-1/2
Motor (HP)	1/2HP, 115V, 1Ph
Floor Space Required (L x W x H / in.)	37 x 16 x 37
Net Weight (lbs.)	160



5" x 6" HORIZONTAL MITERING BANDSAW



DURABILITY

- Sealed worm gear transmission
- Ball bearing drive wheel and blade guides

SAFETY

- Blade guard

EASE OF USE

- Hydraulic down feed control
- Deluxe enclosed stand with handle and wheels for easy movement
- Head swivels for a maximum cut at 45° & 60°
- 1/2" Carbon steel blade
- Adjustable material stop

STOCK NUMBER	414457
Model Number	HBS-56S
CUTTING CAPACITIES	
Round Capacity at 90° (in.)	5
Round Capacity at 45° (in.)	2-3/4
Round Capacity at 60° (in.)	1-3/4
Rectangle Capacity at 90° (in.)	5 x 6; 2 x 6-3/4
Rectangle Capacity at 45° (in.)	4 x 2-3/4; 2 x 3-3/4
Rectangle Capacity at 60° (in.)	5 x 1-3/4
Blade Size (in.)	1/2 x .025 x 64-1/2
Blade Wheel Diameter (in.)	7-3/8
Blade Speed (sfpm)	80, 120, 200
Bed Height (in.)	28
Motor (HP)	1/2HP, 115/230V, 1Ph, Prewired 115V
Floor Space Required (L x W x H / in.)	37 x 20-3/4 x 41
Net Weight (lbs.)	172
OPTIONAL EQUIPMENT	
Replacement Blade - 1/2" x .025" x 64-1/2" x 14R-C	414301



NEW**COMING SEPTEMBER 2017**

5" x 6" HORIZONTAL / VERTICAL VARIABLE SPEED BANDSAW



DURABILITY

- Heavy-duty casted head for years of sawing
- Improved stand with build in shelf
- New DC brushless motor with 3-step gear transmission increases torque output
- Ball bearing supported blade wheel

SAFETY

- CSA/CUS: Following strict guidelines and electrical requirements, this JET Saw is CSA/CUS certified
- Blade is fully guarded
- Automatic shut-off after cut

EASE OF USE

- Variable Speed gives you the ability to cut various materials
- Fully adjustable ball bearing blade guides
- Front legs feature leveling pads
- Wheels come standard for ease of movement around your shop
- Vertical worktable
- Adjustable material stop
- 1/2" Carbon Steel Blade 14T

STOCK NUMBER	414548
Model Number	HVBS-56V
CUTTING CAPACITIES	
Round Capacity at 90° (in.)	5
Round Capacity at 45° (in.)	3
Rectangle Capacity at 90° (in.)	5 (H) x 5-3/4 (W) & 2 (H) x 6 (W)
Rectangle Capacity at 45° (in.)	4-1/2 (H) x 3 (W)
Throat Depth (in.)	5
Vertical Worktable (in.)	9-5/8 x 9-1/2
Vise Swivels (deg.)	45°
Blade Size (in.)	1/2 x .025 x 64-1/2
Blade Wheel Diameter (in.)	7-3/8
Blade Speed (sfpm)	Variable 80 – 230
VARIABLE SPEED RANGES	
Hardened Ferrous (sfpm)	82 - 130
Ferrous (sfpm)	130 - 180
Non-Ferrous, Plastic, Wood (sfpm)	180 - 230
Prewired	115V
Floor Space Required (L x W x H / in.)	36 x 20 x 39 1/2
Motor (HP)	1/2HP, 115V, 1Ph
Net Weight (lbs.)	115
Shipping Weight (lbs.)	121



5" x 6" HORIZONTAL / VERTICAL BANDSAW



DURABILITY

- Heavy-duty 14-gauge stand
- Heat-treated and ground steel worm gear with bronze drive gear
- Ball bearing supported blade wheel

SAFETY

- Automatic shut-off after cut

EASE OF USE

- Large diameter wheels and built-in handle allows easy movement
- Front legs feature adjustable leveling pads
- Fully adjustable ball bearing blade guides
- Three blade speeds
- 1/2" Carbon steel blade

STOCK NUMBER		414458
Model Number	HVBS-56M	
CUTTING CAPACITIES		
Round Capacity at 90° (in.)	5	
Round Capacity at 45° (in.)	3	
Rectangle Capacity at 90° (in.)	5 (H) x 5-3/4 (W) & 2 (H) x 6 (W)	
Rectangle Capacity at 45° (in.)	4-1/2 (H) x 3 (W)	
Throat Depth (in.)	5	
Vertical Worktable (in.)	9-5/8 x 9-1/2	
Vise Swivels (deg.)	45	
Blade Size (in.)	1/2 x .025 x 64-1/2	
Blade Wheel Diameter (in.)	7-3/8	
Blade Speed (sfpm)	80, 120, 200	
Bed Height (in.)	26	
Motor (HP)	1/2HP, 115/230V, 1Ph, Prewired 115V	
Floor Space Required (L x W x H / in.)	36 x 20 x 39.5	
Net Weight (lbs.)	115	
OPTIONAL EQUIPMENT		STOCK NUMBER
Replacement Blade - 1/2" x .025" x 64-1/2" x 14R-C		414301



14", 16", 20" AND 36" VERTICAL BANDSAWS



414483

DURABILITY

- Heavy-duty completely enclosed steel frame
- Blade and tire cleaning brush

SAFETY

- Blade guard
- Rip fence

EASE OF USE

- Multi-tilting work surfaces
- Easy-to-read blade tension indicator
- Variable speeds provide proper adjustments for high efficiency cutting
- Blade welder, grinder & cutter
- Worklamp
- Chip blower

FEATURES OF THE VBS-3612

- Heavy-duty bandsaw can handle large production pieces on its extra large twin tables
- Three wheel system for cutting wide pieces
- Two speed transmission and variable speed allow for wide range of blade speeds
- Two work tables
- 1/4" x 14/18 VT Bi-Metal blade

STOCK NUMBER	414483	414485	414482	414470
Model Number	VBS-1408	VBS-1610	VBS-2012	VBS-3612
Blade Speeds (sfpm)	82 - 330	Low 82 - 330, High 985 - 3,950	Low 65 - 555, High 390 - 3,280	Low 50 - 410, High 550 - 5,000
Height Capacity (max. / in.)	8	10	12	12
Throat Capacity (max. / in.)	14	15-1/2	20	36
Table Size (in.)	20 x 20	22 x 24	24 x 22-1/2	23-5/8 x 27-1/2 and 17-3/4 x 27-1/2
Table Tilt	8° F & B, 12° L, 15° R	8° F & B, 12° L, 15° R	8° F & B, 15° R & 12° L	10° L & 45° R
Blade Length (approx. / in.)	114	123-1/2	156-1/2	197
Blade Width (min-max. / in.)	1/8 - 1/2	1/8 - 5/8	1/8 - 1	1/8 - 1
Table Height (in.)	39	40	39-1/2	40
Motor (HP)	1HP, 115/230V, 1Ph, Prewired 115V	2HP, 230/460V, 3Ph, Prewired 230V	2HP, 230/460V, 3Ph, Prewired 230V	3HP, 230/460V, 3Ph, Prewired 230V
Floor Space Required (L x W x H / in.)	34 x 24 x 68-1/2	37 x 28 x 72-1/2	42 x 30 x 79	69 x 32 x 81
Net Weight (lbs.)	580	900	1210	1,760

OPTIONAL EQUIPMENT	STOCK NUMBER
VBS-3612 Replacement Blade - 1/4" x .025" x 197" x 14R-C	5674030



18" METAL/WOOD VERTICAL BANDSAW

DURABILITY

- Strong steel construction
- Extra large 19" x 19" cast iron table

SAFETY

- Blade guard

EASE OF USE

- Exclusive quick-release, precision T-square style rip fence
- Built-in cutting height scale
- Convenient speed changes with no tools required
- Ball bearing guide system reduces friction for longer blade life
- Lower blade wheel brush and dust collection port



STOCK NUMBER	414418
Model Number	VBS-18MW
Height Capacity (max. / in.)	12
Throat Depth (max. / in.)	18-3/8
Rip left of blade w/fence (max. / in.)	16-1/2
Blade Size (in.)	137 x 3/4 x .035
Blade Length (approx. / in.)	137
Blade Width (min-max. / in.)	1/8 - 1-1/2 (Wood)
Cutting Speeds Wood (sfpm)	1,000, 1,800, 3,200
Cutting Speeds Metal (sfpm)	80, 150, 265
Table Size (in.)	19 x 19
Table Tilt	R 45°, L 10°
Table Height at 90° (in.)	37-1/2
Motor (HP)	1-1/2HP 115/230V, 1Ph, Prewired 115V
Floor Space Required (L x W x H / in.)	42 x 38 x 74
Net Weight (lbs.)	456



14" METAL/WOOD VERTICAL BANDSAW



414500

DURABILITY

- Cast iron frame
- Solid one piece steel base for extra stability
- Exclusive gear box design allows wood/metal model saws to be used for a wider variety of metal, wood, non-ferrous metal, plastic cutting applications

SAFETY

- Conveniently located on/off switch
- Blade guard

EASE OF USE

- Variable speed drive system (J-8201VS)
- Miter gauge
- Dust chute
- Saw blades (wood & metal)
- Adjustable table

STOCK NUMBER	414500	414504C	414502
Model Number	J-8201K	J-8203K	J-8201VS
Blade Speeds Metal (sfpm)	39, 57, 78, 107, 142, 196, 278	39, 57, 78, 107, 142, 176, 278	Variable 90-340
Blade Speeds Wood (sfpm)	3,300	3,300	2,600
Under Guide (in.)	6	6	6
Under Guide with Riser Block (in.)	12	12	12
Height Capacity (max. / in.)	6	6	6
Throat Capacity (max. / in.)	13-1/2	13-1/2	13-1/2
Table Size (in.)	14 x 14	14 x 14	14 x 14
Table Tilt Right	45°	45°	45°
Table Tilt Left	15°	15°	15°
Blade Length (approx. / in.)	92-1/2	92-1/2	92-1/2
Blade Width (min-max / in.)	1/8 - 3/4	1/8 - 3/4	1/8 - 3/4
Miter Gauge Groove W x D (in.)	3/4 x 3/8	3/4 x 3/8	3/4 x 3/8
Table Height (in.)	44	44	44
Motor (HP)	1HP, 115/230V, 1Ph, Prewired 115V	1HP, 230/460V, 3Ph, Prewired 230V	1HP, 115/230V, 1Ph, Prewired 115V
Floor Space Required (L x W x H / in.)	26 x 18-1/2 x 67	26 x 18-1/2 x 67	26 x 18-1/2 x 67
Net Weight (lbs.)	171	155	325

OPTIONAL EQUIPMENT	STOCK NUMBER
Rip Fence — fits all models	5782172
Riser block assembly increases height under the guide by 6" — fits all models	5782181
Replacement Blade - 3/8" x .025" x 92-1/2" x 14R-C	5782722
Replacement Blade - 3/8" x .025" x 92-1/2" x 10R-C	5782723



FK350 SERIES MANUAL FERROUS COLD SAWS

DURABILITY

- 350mm Ferrous cold saw for steel, stainless and tough to cut alloys
- Sturdy gear box design
- Flood coolant system comes standard

SAFETY

- Thermal overload protection with magnetic starter
- Casted blade cover

EASE OF USE

- Double self-centering vise for burr free cuts
- Manually cuts from 45° left to 45° right
- Miter stops at 90°, 45° left to 45° right
- Two cutting speeds



414214K

STOCK NUMBER	414214K	414217K
Model Number	J-FK350-2K	J-FK350-4K
CUTTING CAPACITY FOR TUBING		
Round at 90° (in.)	4-1/2	4-1/2
Round at 45° (in.)	3-1/2	3-1/2
Square at 90° (in.)	4-1/4	4-1/4
Square at 45° (in.)	3-1/2	3-1/2
Rectangle at 90° (in.)	5-1/2 x 3-3/4	5-1/2 x 3-3/4
Rectangle at 45° (in.)	3-1/2 x 3-1/2	3-1/2 x 3-1/2
CUTTING CAPACITY FOR SOLID		
Round at 90° (in.)	2	2
Round at 45° (in.)	1-3/4	1-3/4
Square at 90° (in.)	2	2
Square at 45° (in.)	1-3/4	1-3/4
Blade Size (mm)	350 x 32 x 2.5	350 x 32 x 2.5
Blade Speeds (rpm)	44, 88	44, 88
Maximum Vise Opening (in.)	6	6
Motor (HP)	2HP, 220V, 3Ph	2HP, 440V, 3Ph
Floor Space required (L x W x H/ in.)	50 x 28 x 60	50 x 28 x 60
Net Weight (lbs.)	794	794



CS SERIES MANUAL FERROUS COLD SAWS



414226

DURABILITY

- Heavy-duty cast iron frame base standard
- Hardened and ground worm and wheel gear box
- Flood coolant system with a 1-1/3 gallon coolant tank capacity

SAFETY

- Casted blade cover

EASE OF USE

- Cast dual pivot saw head
- Two cutting speeds

STOCK NUMBER	414226	414228	414227	414229
Model Number	CS-275	CS-275-1	CS-315	CS-315-1
CUTTING CAPACITY FOR TUBING				
Round at 90° (in.)	3-2/7	3-2/7	3-1/2	3-1/2
Round at 45° (in.)	3-2/7	3-2/7	3-1/2	3-1/2
Square at 90° (in.)	2-1/2 x 2-1/2	2-1/2 x 2-1/2	3-1/5 x 3-1/5	3-1/5 x 3-1/5
Square at 45° (in.)	2-1/5 x 2-1/5	2-1/5 x 2-1/5	2-3/5 x 2-3/5	2-3/5 x 2-3/5
Rectangle at 90° (in.)	3-1/9 x 2	3-1/9 x 2	4 x 3-1/5	4 x 3-1/5
Rectangle at 45° (in.)	2-1/5 x 2	2-1/5 x 2	3-1/5 x 2-3/5	3-1/5 x 2-3/5
CUTTING CAPACITY FOR SOLID				
Round at 90° (in.)	3-2/7	3-2/7	3-1/2	3-1/2
Round at 45° (in.)	3-2/7	3-2/7	3-1/2	3-1/2
Square at 90° (in.)	2-1/2 x 2-1/2	2-1/2 x 2-1/2	3-1/5 x 3-1/5	3-1/5 x 3-1/5
Square at 45° (in.)	2-1/5 x 2-1/5	2-1/5 x 2-1/5	2-3/5 x 2-3/5	2-3/5 x 2-3/5
Rectangle at 90° (in.)	3-1/9 x 2	3-1/9 x 2	4 x 3-1/5	4 x 3-1/5
Rectangle at 45° (in.)	2-1/5 x 2	2-1/5 x 2	3-1/5 x 2-3/5	3-1/5 x 2-3/5
Blade Size (mm)	275 x 32 x 2	275 x 32 x 2	315 x 32 x 2	315 x 32 x 2
Blade Speeds (rpm)	54, 108	54	52, 104	54
Maximum Vise Opening (in.)	4	4	4-3/4	4-3/4
Motor (HP)	1.5HP, 230V, 3Ph	1.5 HP, 115/230V, 1Ph, Prewired 115V	2HP, 230V, 3Ph	2 HP, 230V, 1Ph
Floor Space required (L x W x H / in.)	38 x 37 x 64	38 x 37 x 64	39 x 37 x 69	39 x 37 x 69
Net Weight (lbs.)	330	330	390	420



NON-FERROUS HIGH SPEED MANUAL COLD SAWS



414203K

DURABILITY

- Pneumatic mist coolant system

SAFETY

- Casted blade cover
- Safety guards

EASE OF USE

- Double self-centering vise for burr-free cuts
- Capable of slotting
- Mitering capabilities – stops at 90°, 45° left and 45° right
- Two cutting speeds
- Includes one high speed NF 350mm blade (579052)
- 30" material length stop

STOCK NUMBER	414203K	414207K
Model Number	CK350-2K	CK350-4K
CUTTING CAPACITY FOR TUBING		
Round at 90° (in.)	4-1/2	4-1/2
Round at 45° (in.)	3-1/2	3-1/2
Square at 90° (in.)	4-1/4 x 4-1/4	4-1/4 x 4-1/4
Square at 45° (in.)	3-1/2 x 3-1/2	3-1/2 x 3-1/2
Rectangle at 90° (in.)	5-1/2 x 3-3/4	5-1/2 x 3-3/4
Rectangle at 45° (in.)	3-1/2 x 3-1/2	3-1/2 x 3-1/2
CUTTING CAPACITY FOR SOLID		
Round at 90° (in.)	3	3
Round at 45° (in.)	2-1/2	2-1/2
Square at 90° (in.)	3 x 3	3 x 3
Square at 45° (in.)	2-1/2 x 2-1/2	2-1/2 x 2-1/2
Blade Size (mm.)	350 x 32 x 3.4	350 x 32 x 3.4
Blade Speeds (rpm)	1,750, 3,500	1,750, 3,500
Maximum Vise Opening (in.)	6	6
Motor (HP)	2HP, 220V, 3Ph	2HP, 440V, 3Ph
Floor Space Required (L x W x H / in.)	25 x 52 x 73	25 x 52 x 73
Net Weight (lbs.)	683	683



J-F225 BENCH FERROUS COLD SAW



DURABILITY

- Bronze worm gear and hardened ground worm screw gear box in an oil bath
- Coolant system

SAFETY

- Control handle with a safety spring loaded trigger switch to start or stop the machine

EASE OF USE

- Adjustable depth stop
- Blade included
- Manually cuts from 0 - 45° left
- Split jaw vise
- Large coolant tray

STOCK NUMBER		414220
Model Number	J-F225	
CUTTING CAPACITY FOR TUBING		
Round at 90° (in.)	2-1/2	
Round at 45° (in.)	2	
Rectangle at 90° (in.)	2-1/2 x 2-15/16	
Rectangle at 45° (in.)	1-3/4 x 1-1/4	
Square at 90° (in.)	2-1/4	
Square at 45° (in.)	1-5/8 x 1-5/8	
Blade Size (mm.)	225	
Blade Speed (rpm)	52	
Motor (HP)	1HP, 115V, 1Ph	
Floor Space Required (L x W x H / in.)	30 x 17 x 32	
Net Weight (lbs.)	84	

OPTIONAL EQUIPMENT	STOCK NUMBER
Replacement Blade - 225 - 2 - 32 / 180 Teeth	579000
Replacement Blade - 225 - 2 - 32 / 120 Teeth	579002



NEW

12" AND 14" ABRASIVE SAWS



414240

DURABILITY

- Heavy-duty steel cabinet
- Casted head for years of precise cutting and reduced vibration

SAFETY

- CSA/CUS: Following strict guidelines and electrical requirements, these JET Saws are CSA/CUS certified
- Casted blade guard for years of worry free cutting
- Dust port sends all sparks to rear of the saw and away from the operator

EASE OF USE

- Head miters 45° left & right
- Double self-centering vise secures the material and prevents cut material from falling standard on AB-14
- Quick clamping Cam-Action vise with adjustable gib and material support bar standard on the AB-12
- Spring loaded whole hand trigger for smooth cutting action
- Quick tension and release mitering stop at 45°, 90° and -45° standard on the AB-14
- Improved center of gravity for easy head movement

STOCK NUMBER	414240	414245
Model Number	AB-12	AB-14
CUTTING CAPACITY FOR TUBING		
Round Capacity at 90 Degree (in.)	3-29/32	4-11/16
Round Capacity at 45 Degree (in.)	3-1/2	4-7/64
Rectangle Capacity at 90 Degree (in.)	2-11/16 x 4-11/16	3-7/64 x 4-11/16
Rectangle Capacity at 45 Degree (in.)	3-11/16 x 3-1/2	3-1/2 x 3-29/32
Square Capacity at 90 Degree (in.)	3-1/2 x 3-1/2	4-7/64 x 4-7/64
Square Capacity at 45 Degree (in.)	3 x 3	3-1/2 x 3-1/2
Abrasive Wheel Size (in.)	12	14
Blade Speed (sfpm)	4200	4200
Maximum Vise Opening (in.)	7-1/2	5-11/16
Type of Vise	Taper Lock Down	Double Self-Centering
Motor/Electrics (HP)	5HP, 230V, 3-Phase	5HP, 230V, 3-Phase
Overall Dimensions (L x W x H / in.)	44-1/2 x 25 x 61	44-1/2 x 25 x 70
Net Weight (lbs.)	352	430
Gross Weight (lbs.)	462	540



SAW ACCESSORIES

CARBIDE TIPPED COLD SAW BLADES FOR NON-FERROUS MATERIALS

- Three tooth precision tungsten carbide style blades
- General purpose blades
- The 84 teeth blade is for use on medium size solids and extrusions
- The 108 teeth blade is for use on small size solids, tubing and small size extrusions
- These blades are for use on CK High Speed Cold Saws only



STOCK NUMBER	DESCRIPTION
579036	350-2.5-32/360T
579062	350 - 3.4 - 32 / 84 teeth
579064	350 - 3.4 - 32 / 108 teeth
579052	350-3.4-32/180T

MATERIAL SUPPORT STANDS

- Heavy-duty cast iron and steel construction
- Chrome plated ball bearing roller head
- Locking screws provide added safety
- The roller heads are interchangeable

STOCK NUMBER	414121	414122
Weight Holding Capacity (lbs.)	2,000	2,000
Minimum Stock Diameter (in.)	-	1
Maximum Stock Diameter (in.)	-	12
Length of Horizontal Roller (in.)	14	-
Height Range (in.)	23.5 - 38.5	23.5 - 38.5
Base/3 Legs Area Required (in.)	16.5 x 16.5 Square	16.5 x 16.5 Square
Stand Dimensions (L x W x H / in.)	22 x 22 x 5	22 x 22 x 5
Net Weight (lbs.)	30	30



414121

414122



SAWING HELPFUL INFO

Using the right saw blade is critical to the success of every job. Review the information provided below to equip your JET saws with the proper blade for any job.



CHOOSING A SAW BLADE

A FABRICATION OR METAL SHOP HAS DIVERSE CUTTING REQUIREMENTS, SO CHOOSING THE PROPER BLADES TO SUIT ALL THE REQUIRED APPLICATIONS ON YOUR JET SAW IS VITAL.

You need to ask yourself how can I get the lowest cost per cut while maintaining acceptable levels of surface finish. If you think in these terms, it will be easy to select blades that optimize metal separation productivity and profitability. Fabrication or metal shops use band saws for many different kinds of cutting, including solid materials and heavy-wall tubing, structural shapes, high-efficiency bundle cutting, and hard alloy materials such as tool steels. No one blade is perfect for all of these. After choosing the correct replacement blade for your JET saw, you still have to use it intelligently. Subjecting blades to different types of cutting shortens blade life. Understanding why is the key not only to selecting the right blade, but also to making it last. When blades are used for cutting structural steels or bundles, the teeth are subjected to multiple impacts of different intensities from different directions. In shops, most bandsaw blades fail because of these repeated shocks, not excessive wear. What is most often needed then is a blade design tough enough to withstand these impacts, and still cut at a relatively fast speed while leaving a smooth finish on the product that won't require secondary operations such as filing and grinding. Such blades deliver the lowest cost per cut and by far the best value. Discovering what blade and teeth geometry best fits your usage pattern requires a look at the type and size of equipment, as well as the section sizes and shapes most frequently cut. Most blades used in fabrication are bimetal. These industry workhorses can be configured to withstand the impact punishment delivered in shops that primarily cut shapes and bundles, yet they are hard enough for continuous use with solids and heavy-walled tubing. They can even withstand the wear from the occasional cutting of high-alloy steels.

OTHER PROPERTIES TO CONSIDER:

- **Blade width:** Use the widest blade your machine will take, except when cutting contours.
- **Tooth rake:** Select the appropriate rake, or tooth angle, for the materials and shapes to be cut. A positive rake is best for thick solids and heavy-wall tubing. Straight or less positive rakes are preferred for most structural and bundle cutting.
- **Tooth shape:** Many different tooth shapes are available. A few examples follow:
 - **Regular:** A conventional tooth used for general-purpose sawing with a straight (zero) rake.
 - **Hook:** A 10-degree positive rake for fast cutting of nonferrous metals, non-metallics, plastics, and wood.
 - **Skip:** A straight (zero) rake with shallow gullets for cutting large sections of soft nonferrous materials, plastics, and wood.
- **Pitch:** Pitch is defined as the number of teeth within a certain distance (25 mm, or 1 in.) of blade. Cutting thin sections of material requires a fine pitch (more teeth). Thicker sections require more coarse pitches (fewer teeth). Always strive for a minimum of three teeth in the cut. Having six to 12 teeth in the cut at any time is optimal.
- **A constant pitch—**with all teeth of the blade having a uniform spacing, gullet depth, and rake angle throughout the full length—typically is used for general-purpose cutting. Variable-pitch blades have various tooth sizes and gullet depths to substantially reduce noise and vibration. This helps cut structural, tubing, and solids smoothly and quickly. Two numbers signifying the lowest/highest pitch on the blade identify this style (for instance, 10/14).

GENERAL BLADE GUIDELINES

GENERAL GUIDELINES TO HELP YOU CHOOSE THE CORRECT BLADE FOR YOUR JET SAW:

CHOOSING THE TPI (Tooth Per Inch):

Choosing the correct TPI (tooth per inch) is very important. The proper TPI varies with the material thickness to be cut. The thinner the material, the finer the pitch. The following are general guidelines to help you choose an appropriate TPI for your application.

- 1/4" or less use a fine pitch of 14/18 TPI.
- 1/4" to 7/16" use 10/14 TPI.
- 7/16" to 9/16" use 8/12 TPI.
- 9/16" to 11/16" use 6/10 TPI.
- 3/4" to 1" use 5/8 TPI.
- 1-2" use 4/6 TPI.
- 2-5" use 3/4 TPI.
- 5-10" use 2/3 TPI.
- 10-20" use 1"/1.5" TPI.
- 20" + use .8/1 TPI.

CHOOSE A LOWER TPI IF SPEED OF CUT IS IMPORTANT, CHOOSE A HIGHER TPI IF FINISH IS MORE IMPORTANT.

- A higher TPI will provide a smoother finish but at a slower pace.
- A lower TPI will provide for faster cuts but with rougher finishes.
- A higher TPI (10/14, 14/18) is recommended for thin cross sections (1/4" & under).
- A lower TPI (3/4, etc.) is recommended for thick cross sections (2" & larger).
- Improper TPI for hard to cut materials will shorten the blade life.
- A tooth pitch that is too high for the cross section will result in chip removal problems, slower cut rates and significantly reduced blade life.
- A tooth pitch that is too low for the cross section tends to produce thick chips, band breakage, stalling in the work piece and tooth strippage/damage.
- As a rule of thumb, a pitch towards the coarse end for a particular cross section is preferable to a pitch that is too fine. Adjustments made to the speed and feed can assist in obtaining the most efficient sawing.
- For bundles, select a slightly lower TPI than appropriate for a single piece.

BLADESAW TERMINOLOGY AND BASIC CUTTING SOLUTIONS

JET STRIVES TO MAKE YOUR JOB EASIER, BY PROVIDING YOU WITH HELPFUL INFORMATION ON BANDSAW BLADES

BANDSAW BLADE TERMINOLOGY:

- Tooth Form: Straight (constant), Variable, Hook and Skip.
- Tooth Pitch: Distance from one tooth to the next.
- TPI (teeth per inch): ranging from .8-32
- Width: Distance from top of tooth to bottom of blade backing.
- Gage: The thickness of the blade, ie. .025", .035" etc.
- Rake Angle (tooth angle): Standard (0 degree) and Positive (3-12 degree).
- Gullet: The round root portion between the teeth.
- Kerf: The width of cut in the material being sawed. Kerf is a combination of the thickness of the blade plus the width of the tooth set.
- Tooth Set: The tilt of the teeth which provides clearance in the cut. The set to right and left of center is a factor in determining the width of the kerf.
- Raker Set: One tooth tilted left, then right, then straight. Standard design for most applications.
- Wavy Set: Groups of teeth tilting left, then right throughout the blade. Useful when tooth strippage is a problem on thin cross sections such as tubing, sheet stock. These are recommended for light-duty saws.

BASIC CUTTING PROBLEMS / SOLUTIONS:

- Tooth Damage - Blade mounted backwards, teeth in wrong orientation, blade "break-in" insufficient, inappropriate feed/speed, and hardened material.
- Blade Damage - Use higher TPI, lower blade tension, use thinner gage blade, check coolant, inappropriate feed/speed, and check guides.
- Chip welding - tooth size too small, excessive speeds/feeds, insufficient coolant flow.
- The biggest reasons for sawing problems are inappropriate pitch (TPI) and/or improper speeds and feeds for the material type, size and shape being cut. This is especially true when using economy blades of inferior quality. Often, the quality of the chip produced will tell you if you have appropriate speed and feed. Excessive speed and/or too fine of pitch tends to produce a thin, spiral bluish chip and/or cause chip welding. Too low of speed and/or too coarse of pitch tends to cause the teeth to take chunks of material and/or cause tooth breakage and workpiece stalling. When pitch, speeds and feeds are correct, you should see a good quality chip curl with minimal sound and vibration coming from the saw.



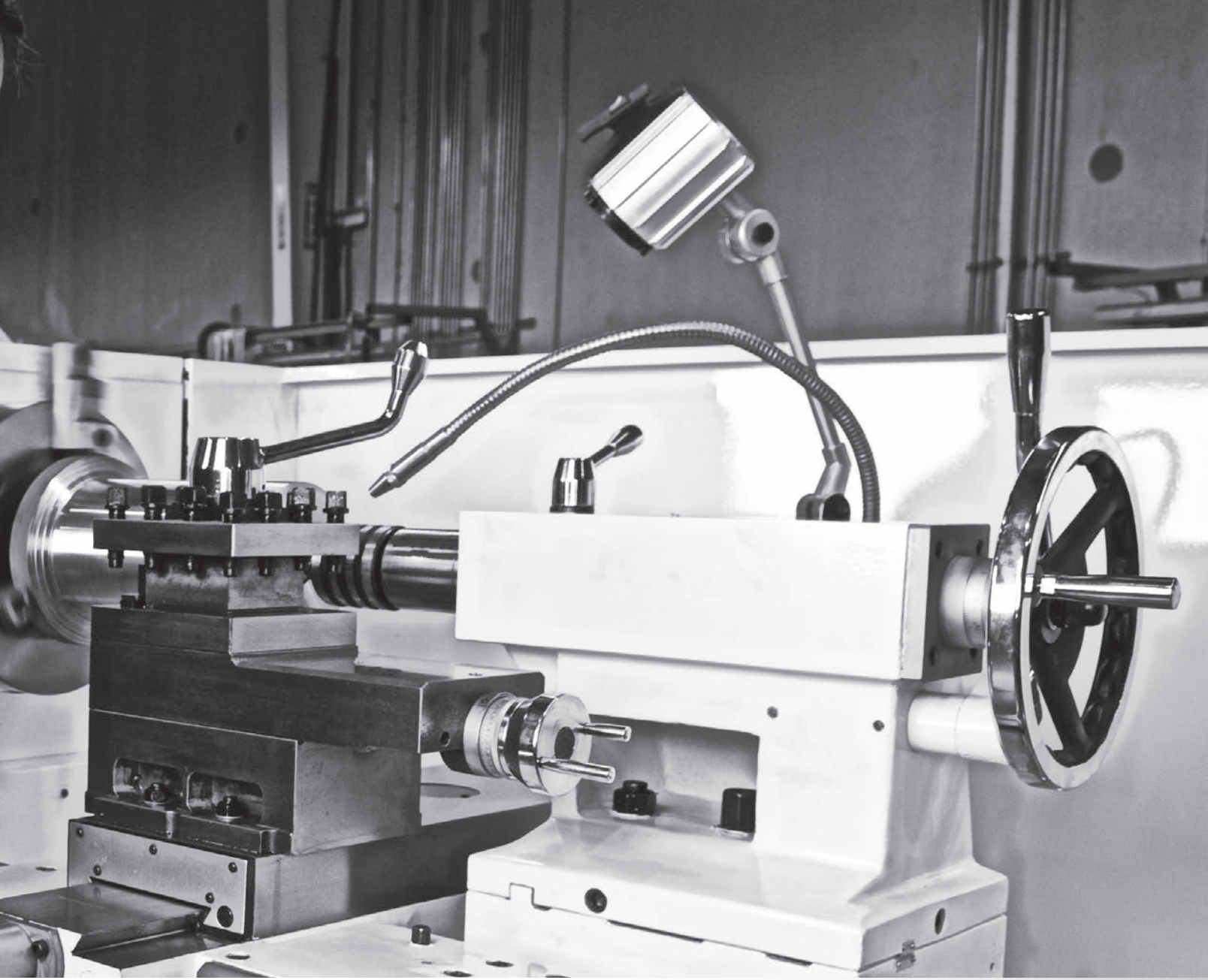

TURNING

Precision manufactured to meet the demands of even the highest volume shop, JET's extensive selection of lathes enable experts to choose the lathes they need for any turning operation. JET lathes come equipped with the taper attachments, collet closers, digital readouts and accessories the pros need to turn precision parts. Every JET machine is backed by an industry-leading Two Year Warranty. Premier customer support and professional manuals ensure optimal functioning and operation. Precision manufactured to meet your demands.

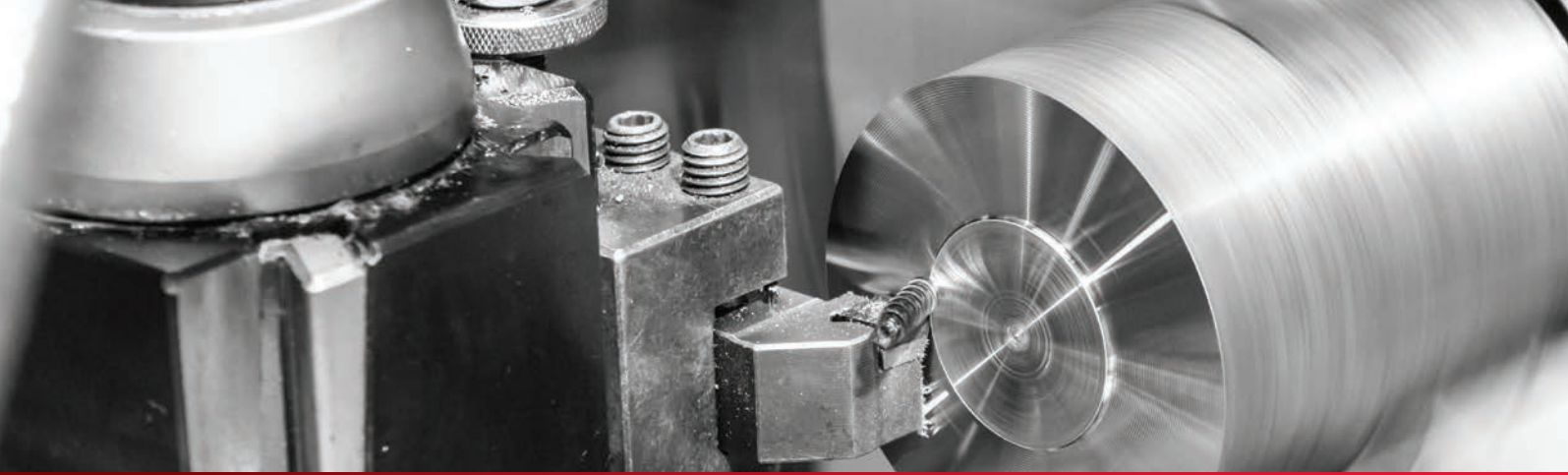

CHOOSE YOUR LATHE QUICK REFERENCE GUIDE

BASE MACHINE	MODEL	DESCRIPTION	SWING OVER BED (in.)	DISTANCE BETWEEN CENTERS (in.)	SPINDLE BORE (in.)	TAPER SPINDLE MOUNT	MOTOR	PAGE NUMBER
LARGE SPINDLE BORE GEARED HEAD ENGINE LATHE								
321890	GH26120ZH	4-1/8" Spindle Bore Geared Head Lathe	26	120	4-1/8	D1-8	10 HP, 230/460V, 3Ph	46
321860	GH-2680ZH	4-1/8" Spindle Bore Geared Head Lathe	26	80	4-1/8	D1-8	10 HP, 230/460V, 3Ph	46
321980	GH-2280ZX	3-1/8" Spindle Bore Geared Head Lathe	22	80	3-1/8	D1-8	10 HP, 230/460V, 3Ph	48
321970	GH-1880ZX	3-1/8" Spindle Bore Geared Head Lathe	18	80	3-1/8	D1-8	7-1/2 HP, 230/460V, 3Ph	48
321960	GH-1860ZX	3-1/8" Spindle Bore Geared Head Lathe	18	60	3-1/8	D1-8	7-1/2 HP, 230/460V, 3Ph	48
321940	GH-1660ZX	3-1/8" Spindle Bore Geared Head Lathe	16	60	3-1/8	D1-8	7-1/2 HP, 230/460V, 3Ph	48
321930	GH-1640ZX	3-1/8" Spindle Bore Geared Head Lathe	16	40	3-1/8	D1-8	7-1/2 HP, 230/460V, 3Ph	48
321910	GH-1440ZX	3-1/8" Spindle Bore Geared Head Lathe	14	40	3-1/8	D1-8	7-1/2 HP, 230/460V, 3Ph	48
GEARED HEAD BENCH LATHE								
321357A	GHB-1340A	1-3/8" Spindle Bore Geared Head Bench Lathe	13	43	1-1/2	D1-4	2 HP, 230V, 1Ph	52
BELT DRIVE BENCH LATHE								
321360A	BDB-1340A	1-3/8" Spindle Bore Belt Drive Bench Lathe	13	40	1-3/8	D1-4	2 HP, 230V, 1Ph	54

*See product pages for package options

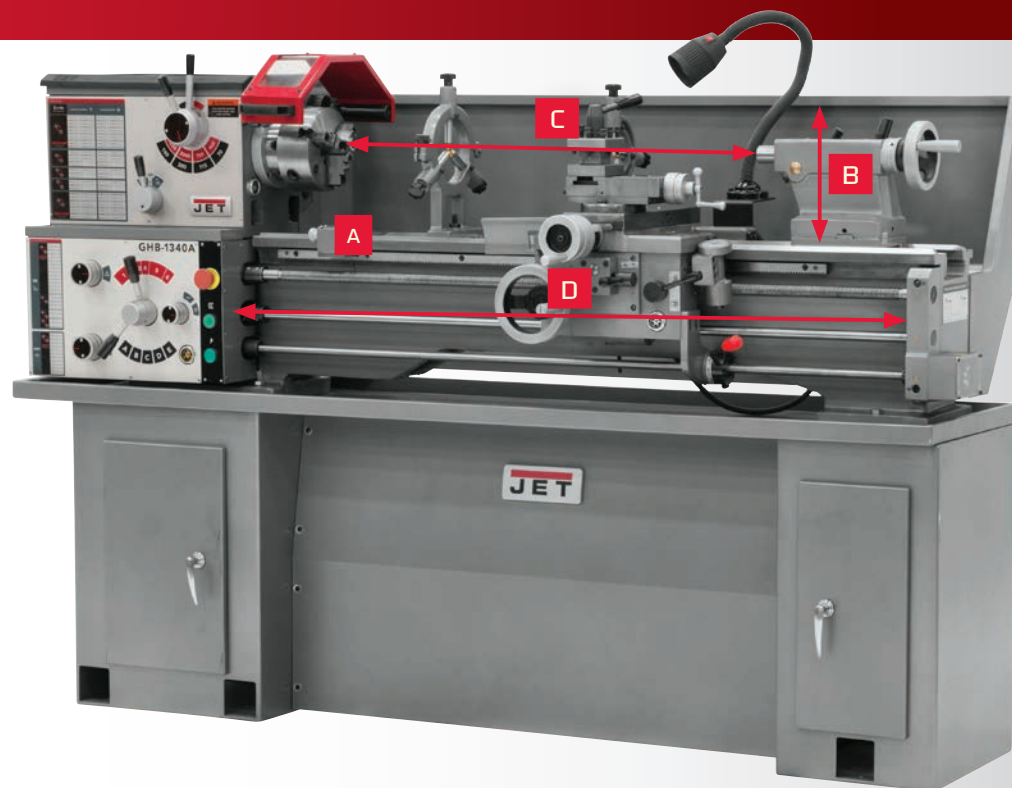
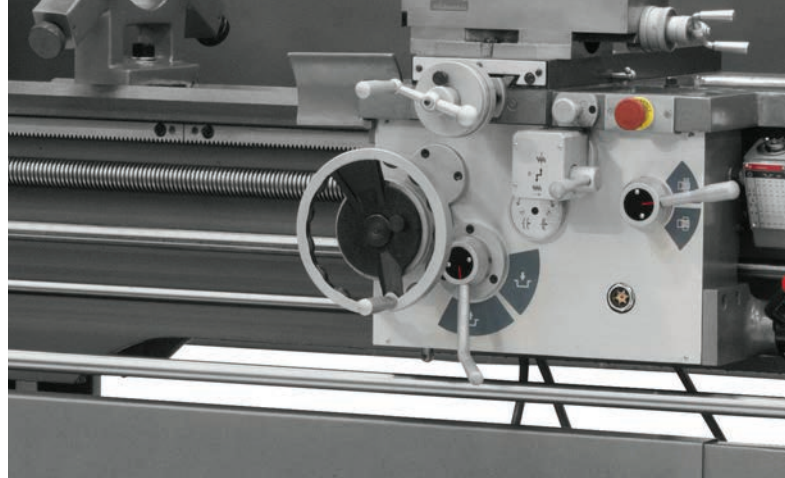
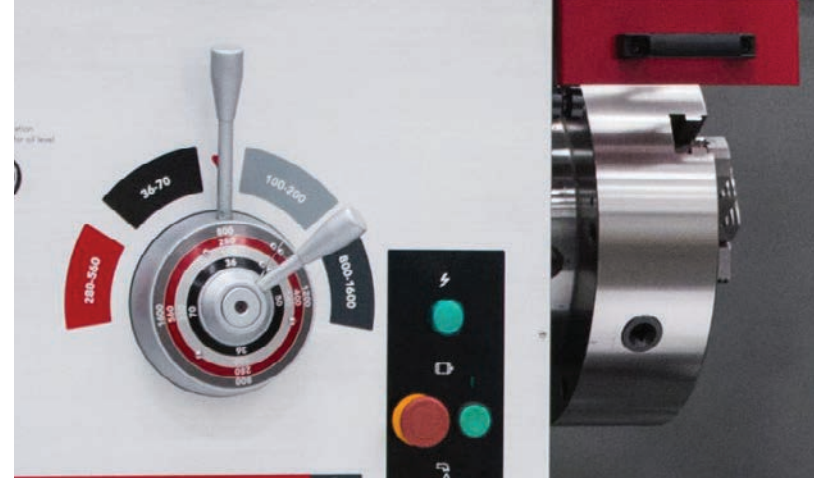

COMMON LATHE TERMINOLOGY

- A** GAP: THE GAP ALLOWS YOU TO TURN A LARGER DIAMETER WORK PIECE.
- B** SWING (EX: 14")
- C** DISTANCE BETWEEN CENTERS IS FROM CHUCK TO TAILSTOCK
- D** LENGTH OF BED

TURNING HELPFUL INFO

The size of an engine lathe is determined by the largest piece of stock that can be machined. Before machining a workpiece, the following measurements must be considered: the diameter of the work that will swing over the bed and the length between lathe centers.

Engine lathes all have the same general functional parts; the bed is the foundation of the working parts of the lathe. The main feature of its construction is the ways which are formed on its upper surface and run the full length of the bed. Ways provide the means for holding the tailstock and carriage, which slide along the ways, in alignment with the permanently attached headstock.

The **headstock** is located on the operator's left end of the lathe bed. It contains the main spindle and oil reservoir and the gearing mechanism for obtaining various spindle speeds and for transmitting power to the feeding and threading mechanism. The headstock

is driven by an electric motor connected either to a belt, pulley or geared system. The spindle has a hole through its entire length to accommodate long workpieces.

The **tailstock** is located on the opposite end of the lathe from the headstock. It supports one end of the workpiece when machining between centers, supports long pieces held in the chuck, and holds various forms of cutting tools such as drills, reamers and taps.

The **carriage** includes the apron, saddle, compound rest, cross slide, tool post and the cutting tool. It sits across the ways and in front of the bed. The function of the carriage is to carry and move the cutting tool. It can be moved by hand or power and can be clamped into position with a locking nut. The saddle carries the cross slide and the compound rest. The cross slide is mounted on the ways on top of the saddle and is moved back and forth at 90 degrees to the axis of the lathe by the cross slide lead screw.

26" LARGE SPINDLE BORE LATHES



321890

DURABILITY

- Large 4-1/8" spindle bore
- Clutch operated headstock with all headstock gears hardened and ground
- Bed ways are induction hardened and ground for durability
- Heavy-duty tailstock and quill
- One piece heavy-duty cast iron base and bed for GH-2680ZH
- Meehanite casting
- Siemens electric

SAFETY

- Large easy to use foot brake
- E-stop on carriage
- Full length splash guard and coolant return
- Chuck guard
- Articulating LED work lamp
- Chuck key holder will not allow lathe to run without the chuck key in place

EASE OF USE

- Rapid power traverse on cross slide and carriage is a great addition to these lathes that allows the user to access the work piece quickly. The joy stick design enhances overall ergonomics.
- Universal gearbox allows inch, metric, diametral and module pitch threads, no change gears required
- Micro-carriage bed stop



321860

STANDARD EQUIPMENT

- Drive plate
- 12" 3-Jaw direct mount scroll chuck with top reversing jaws
- Face plate
- 2 Large capacity steady rests with roller bearings
- Follow rest
- 5-Piece quick change tool post set
- Coolant system
- Fitted top mats to hold tooling



OPTIONAL EQUIPMENT	STOCK NUMBER
Taper Attachment	321293

STOCK NUMBER	321860	321890
Model Number	GH-2680ZH	GH-26120ZH
Max. swing over bed (in.)	26	26
Max. swing over cross slide (in.)	16-1/2	16-1/2
Swing Through Gap (in.)	34	34
Length of Gap (in.)	8	8
Distance between Centers (in.)	80	120
Hole Through Spindle (in.)	4-1/8	4-1/8
Spindle Mount	D1-8	D1-8
Spindle Taper	MT-5	MT-5
Number of Spindle Speeds	12	12
Range of Spindle Speeds (rpm)	36-1,600	36-1,600
Number of Longitudinal Feeds (in.)	65	65
Range of Longitudinal Feeds (ipr)	.0023-.0937	.0023-.0937
Number of Cross Feeds	63	63
Range of Cross Feeds (ipr)	.0010-.0404	.0040-.0404
Number of inch Threads (tpi)	48	48
Range of inch Threads	2-30	2-30
Number of Metric Threads	22	22
Range of Metric Threads (mm)	1-14	1-14
Number of D.P Threads	24	24
Range of D.P Threads	4-56 DPI	4-56 DPI
Number of Module Threads	18	18
Range of Module Threads (mm)	0.5-7	0.5-7
Max. Tool Size (in.)	1-1/4 x 1-1/4	1-1/4 x 1-1/4
Max. Compound Slide Travel (in.)	5-1/2	5-1/2
Max. Cross Slide Travel (in.)	12-3/32	12-3/32
Max. Carriage Travel (in.)	72-1/2	108-1/4
Tailstock Spindle Travel (in.)	6	6
Taper in Tailstock Spindle	MT-5	MT-5
Follow Rest Capacity	25/32 - 3-15/16	25/32 - 3-15/16
Steady Rest Capacity - Small (in.)	25/32 - 4-29/32	25/32 - 4-29/32
Steady Rest Capacity - Large (in.)	3-15/16 - 9-7/16	3-15/16 - 9-7/16
Width of Bed (in.)	16	16
Coolant Pump System (HP)	1/8	1/8
Main Motor (HP)	10HP, 230/460V, 3Ph	10HP, 230/460V, 3Ph
Prewired	230V	230V
Net Weight (lbs.)	8514	9362
Overall Dimensions (L x W x H / in.)	138 x 43 x 57	178 x 43 x 57

GH-2680ZH-SERIES PRECISION ENGINE LATHE PACKAGES

321864	GH-2680ZH with Taper Attachment
321863	GH-2680ZH with ACU-RITE 200S DRO
321865	GH-2680ZH with ACU-RITE 200S DRO and Taper Attachment
321861	GH-2680ZH with Newall DP700 DRO
321862	GH-2680ZH with Newall DP700 DRO and Taper Attachment

GH-26120ZH-SERIES PRECISION ENGINE LATHE PACKAGES

321893	GH-26120ZH with Taper Attachment
321892	GH-26120ZH with ACU-RITE 200S DRO
321895	GH-26120ZH with ACU-RITE 200S DRO with Taper Attachment
321896	GH-26120ZH with ACU-RITE 300S DRO
321891	GH-26120ZH with Newall DP700 DRO
321894	GH-26120ZH with Newall DP700 DRO and Taper Attachment

14"-22" ZX SERIES LARGE SPINDLE BORE LATHES

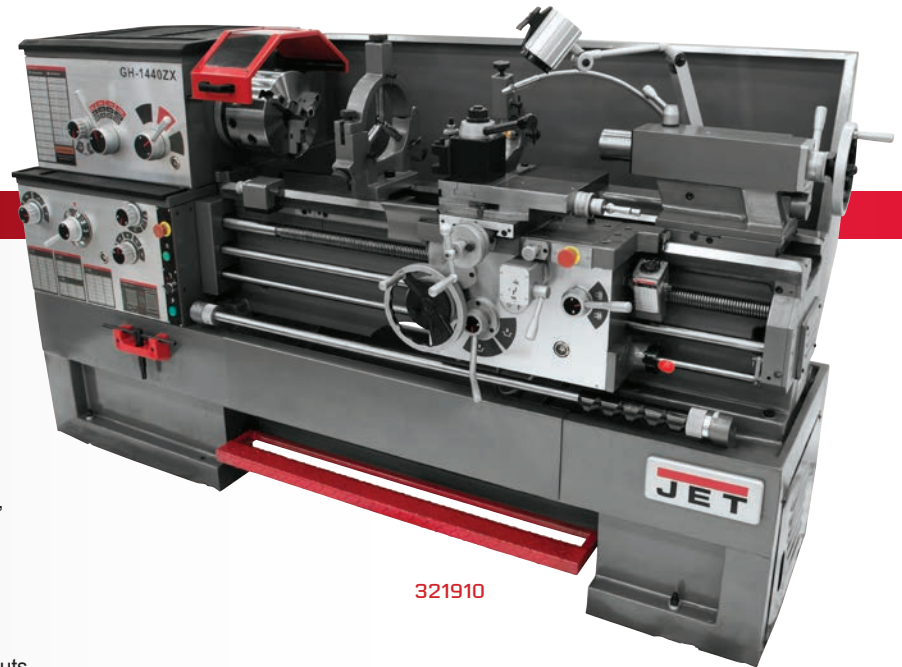

321910

DURABILITY

- 3-1/8" bore spindle is supported by two tapered and one ball bearing
- High quality ANSI Class 50 wear-resistant cast iron bed ways are hardened and ground
- Chrome molybdenum headstock gears are hardened, ground, and shaved
- Carriage features one-shot lubrication and Turcite B on bed sliding surfaces
- Meehanite casting
- One-piece cast iron base absorbs vibration allowing heavier cuts
- Siemens electrics

SAFETY

- Large easy-to-use foot brake
- E-Stop on carriage
- Full length splash guard and coolant return
- Chuck guard
- Articulating LED work lamp
- Chuck key holder will not allow lathe to run without the chuck key in place

EASE OF USE

- Universal gearbox allows inch, metric, diametral, and module pitch threads, no change gears required
- Front removable chip tray
- T-slotted compound slide featuring a quick-change tool post
- Removable gap allows up to 25-7/8" diameter work on 16", 27-1/2" on 18"
- Five position automatic carriage stop increases productivity
- Threading dial
- Fitted top mats to hold tooling
- Centrally located controls with job button

STANDARD EQUIPMENT

- 10" 3-jaw scroll chuck with top reversing jaws
- 12" face plate (16" models)
- 16" face plate (18" models)
- 5 Piece quick change tool post set
- Follow rest
- Large capacity steady rest with ball bearing tips
- Fully integrated coolant system
- Centrally located controls with jog button
- Mounting pads and levelers
- Spindle sleeve (MT-7 to MT-5)
- Live center
- Tolerance test certificate
- Tool box and adjusting tools



OPTIONAL EQUIPMENT	STOCK NUMBER
5C Lever-Type Collet Closer	321292
Taper Attachment	321291

STOCK NUMBER	321910	321930	321940	321960	321970	321980
Model Number	GH-1440ZX	GH-1640ZX	GH-1660ZX	GH-1860ZX	GH-1880ZX	GH-2280ZX
Swing over Bed (in.)	14	16	16	18	18	22
Swing over Cross Slide (in.)	7-5/8	10	10	11	11	13
Swing Through Gap (in.)	23-5/8	25	25	27	27	29
Length of Gap (in.)	12	12	12	12	12	12
Distance Between Centers (in.)	40	40	60	60	80	80
Spindle Bore (in.)	3-1/8	3-1/8	3-1/8	3-1/8	3-1/8	3-1/8
Spindle Mount	D1-8	D1-8	D1-8	D1-8	D1-8	D1-8
Spindle Taper (w/ sleeve)	MT-7 (MT-5)	MT-7 (MT-5)	MT-7 (MT-5)	MT-7 (MT-5)	MT-7 (MT-5)	MT-7(MT-5)
Number of Spindle Speeds	12	12	12	12	12	12
Range of Spindle Speeds (rpm)	42 - 1,800	25 - 1,800	25 - 1,800	25 - 1,800	25 - 1,800	25 - 1,800
Number of Longitudinal and Cross Feed Rates	122	122	122	122	122	122
Range of Longitudinal Feeds (ipr)	.0015 - .0913	.0015 - .0913	.0015 - .0913	.0015 - .0913	.0015 - .0913	.0015 - .0913
Range of Cross Feeds (ipr)	.0006 - .0365	.0006 - .0365	.0006 - .0365	.0006 - .0365	.0006 - .0365	.0006 - .0365
Number of inch Threads	61	61	61	61	61	61
Range of inch Threads (tpi)	1-5/8 - 72	1-5/8 - 72	1-5/8 - 72	1-5/8 - 72	1-5/8 - 72	1-5/8 - 72
Number of Metric Threads	24	24	24	24	24	24
Range of Metric Threads	.05 - 20	.05 - 20	.05 - 20	.05 - 20	.05 - 20	.05 - 20
Max Tool Size (in.)	1 x 1	1 x 1	1 x 1	1 x 1	1 x 1	1 x 1
Compound Slide Travel (in.)	5-1/8	5-1/8	5-1/8	5-1/8	5-1/8	5-1/8
Cross Slide Travel (in.)	9	9	9	9	9	12
Carriage Travel (in.)	36	36	55	55	74	74
Tailstock Spindle Travel (in.)	6	6	6	6	6	6
Taper in Tailstock Spindle	MT-4	MT-4	MT-4	MT-5	MT-5	MT-5
Steady Rest Capacity (in.)	3/8 to 7	3/8 to 7	3/8 to 7	3/8 to 7-3/4	3/8 to 7-3/4	3/8 to 7-3/4
Follow Rest Capacity (in.)	1/2 - 3-1/2	1/2 - 3-1/2	1/2 - 3-1/2	1/2 - 3-1/2	1/2 - 3-1/2	1/2 - 3-1/2
Width of Bed (in.)	13-1/8	13-1/8	13-1/8	13-1/8	13-1/8	13-1/8
Overall Dimensions (L x W x H / in.)	96 x 44 x 66	96 x 44 x 66	115 x 44 x 66	115 x 44 x 66	136 x 44 x 66	136 x 45 x 71
Motor (HP)	7-1/2HP, 230V/460V 3Ph, Prewired 230V	7-1/2HP, 230/460V, 3Ph, Prewired 230V	7-1/2HP, 230/460V, 3Ph, Prewired 230V	7-1/2HP, 230/460V, 3Ph, Prewired 230V	7-1/2HP, 230/460V, 3Ph, Prewired 230V	10HP, 230/460V, 3Ph, Prewired 230V
Net Weight (lbs.)	4667	4689	5218	5320	5949	6421

14"-22" ZX SERIES LARGE SPINDLE BORE LATHES PACKAGES

Jet will customize your machine to fit your application.

We factory install DRO's, collect closers, taper attachments or any combination to accommodate the needs of your shop.

GH-1440ZX LARGE SPINDLE BORE PRECISION ENGINE LATHE PACKAGES

321467	GH-1440ZX, 3-1/8" Spindle Bore Geared Head Lathe with Taper Attachment
321467	GH-1440ZX with Taper Attachment
321531	GH-1440ZX with Collet Closer
321309	GH-1440ZX with ACU-RITE VUE DRO
321469	GH-1440ZX with ACU-RITE 200S DRO
321507	GH-1440ZX with ACU-RITE 200S DRO with Taper Attachment
321501	GH-1440ZX with ACU-RITE 200S DRO with Collet Closer
321569	GH-1440ZX with ACU-RITE 200S DRO with Taper Attachment and Collet Closer
321301	GH-1440ZX with ACU-RITE 300S DRO
321303	GH-1440ZX with ACU-RITE 300S DRO with Taper Attachment
321304	GH-1440ZX with ACU-RITE 300S DRO with Collet Closer
321302	GH-1440ZX with ACU-RITE 300S DRO with Taper Attachment and Collet Closer
321470	GH-1440ZX with Newall DP700 DRO
321570	GH-1440ZX with Newall DP700 DRO with Taper Attachment
321441	GH-1440ZX with Newall DP700 DRO with Collet Closer
321498	GH-1440ZX with Newall DP700 DRO with Taper Attachment and Collet Closer

GH-1640ZX LARGE SPINDLE BORE PRECISION ENGINE LATHE PACKAGES

321474	GH-1640ZX with Taper Attachment
321439	GH-1640ZX with Collet Closer
321475	GH-1640ZX with ACU-RITE 200S DRO
321525	GH-1640ZX Lathe with 3-Axis Acu-Rite 200S DRO
321508	GH-1640ZX with ACU-RITE 200S DRO with Taper Attachment
321495	GH-1640ZX with ACU-RITE 200S DRO with Collet Closer
321445	GH-1640ZX with ACU-RITE 200S DRO with Taper Attachment and Collet Closer
321381	GH-1640ZX with ACU-RITE 300S DRO
321382	GH-1640ZX with ACU-RITE 300S DRO with Taper Attachment
321383	GH-1640ZX with ACU-RITE 300S DRO with Collet Closer
321138	GH-1640ZX with Newall DP700 DRO
321148	GH-1640ZX with Newall DP700 DRO with Taper Attachment
321494	GH-1640ZX with Newall DP700 DRO with Collet Closer
321147	GH-1640ZX with Newall DP700 DRO with Taper Attachment and Collet Closer

GH-1660ZX LARGE SPINDLE BORE PRECISION ENGINE LATHE PACKAGES

321477	GH-1660ZX with Taper Attachment
321573	GH-1660ZX with Collet Closer
321544	GH-1660ZX with Taper Attachment and Collet Closer
322441	GH-1660ZX with ACU-RITE VUE DRO
322455	GH-1660ZX with ACU-RITE VUE DRO with Taper Attachment
322440	GH-1660ZX with ACU-RITE VUE DRO with Collet Closer
321574	GH-1660ZX with ACU-RITE VUE DRO with Taper Attachment and Collet Closer
321455	GH-1660ZX with ACU-RITE 200S DRO
321543	GH-1660ZX with ACU-RITE 200S DRO with Taper Attachment
321440	GH-1660ZX with ACU-RITE 200S DRO with Collet Closer
321576	GH-1660ZX with ACU-RITE 200S DRO with Taper Attachment and Collet Closer
321388	GH-1660ZX with ACU-RITE 300S DRO
321389	GH-1660ZX with ACU-RITE 300S DRO with Taper Attachment
321390	GH-1660ZX with ACU-RITE 300S DRO with Collet Closer
321391	GH-1660ZX with ACU-RITE 300S DRO with Taper Attachment and Collet Closer
321139	GH-1660ZX with Newall DP700 DRO
321527	GH-1660ZX with Newall DP700 DRO with Collet Closer
321529	GH-1660ZX with Newall DP700 DRO with Taper Attachment
321502	GH-1660ZX with Newall DP700 DRO with Taper Attachment and Collet Closer

14"-22" ZX SERIES LARGE SPINDLE BORE LATHES PACKAGES

GH-1880ZX LARGE SPINDLE BORE PRECISION ENGINE LATHE PACKAGES

321486	GH-1880ZX with Taper Attachment
322486	GH-1880ZX with Taper Attachment and Collet Closer
321487	GH-1880ZX with ACU-RITE 200S DRO
321560	GH-1880ZX with ACU-RITE 200S DRO with Taper Attachment
321492	GH-1880ZX with ACU-RITE 200S DRO with Collet Closer
321493	GH-1880ZX with ACU-RITE200S DRO with Taper Attachment and Collet Closer
321595	GH-1880ZX with ACU-RITE 300S DRO
321597	GH-1880ZX with ACU-RITE 300S DRO with Taper Attachment
321598	GH-1880ZX with ACU-RITE 300S DRO with Collet Closer
321599	GH-1880ZX with ACU-RITE 300S DRO with Taper Attachment and Collet Closer
321488	GH-1880ZX with Newall DP700 DRO
321571	GH-1880ZX with Newall DP700 DRO with Taper Attachment
321583	GH-1880ZX Lathe with Newall DP700 DRO with Collet Closer
321578	GH-1880ZX with Newall DP700 with Taper Attachment and Collet Closer

GH-2280ZX LARGE SPINDLE BORE PRECISION ENGINE LATHE PACKAGES

321565	GH-2280ZX with Taper Attachment
321496	GH-2280ZX with Collet Closer
321575	GH-2280ZX with Taper Attachment and Collet Closer
321879	GH-2280ZX with ACU-RITE 200S DRO
321566	GH-2280ZX with ACU-RITE 200S DRO with Collet Closer
321567	GH-2280ZX with ACU-RITE 200S DRO with Taper Attachment
321568	GH-2280ZX with ACU-RITE 200S DRO with Taper Attachment and Collet Closer
321610	GH-2280ZX with ACU-RITE 300S DRO
321612	GH-2280ZX with ACU-RITE 300S DRO with Taper Attachment
321613	GH-2280ZX with ACU-RITE 300S DRO with Collet Closer
321615	GH-2280ZX with ACU-RITE 300S DRO with Taper Attachment and Collet Closer
321880	GH-2280ZX with Newall DP700 DRO
321881	GH-2280ZX with Newall DP700 DRO with Taper Attachment
321579	GH-2280ZX with Newall DP700 DRO with Taper Attachment and Collet Closer

13" x 40" GEARED HEAD BENCH LATHE

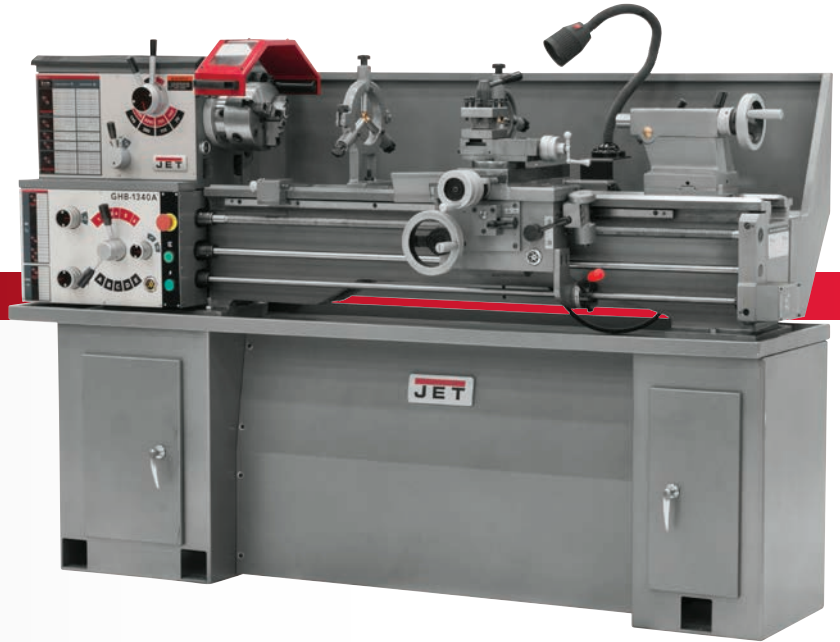

DURABILITY

- Enclosed gearbox design provides smooth, quiet operation
- Hardened and ground gears are featured in the headstock and gearbox
- V-way bed is induction hardened and ground
- D1-4 spindle is precision ground for accuracy and supported by high quality tapered roller bearings
- Headstock is constantly oiled during operation

SAFETY

- Splash guard
- Chuck guard
- E-Stop on headstock
- Full length splash guard

EASE OF USE

- Gap bed section provided for large diameter work
- Adjustable gibs are incorporated in the carriage and slideways
- Fast, easy speed changes
- Gear box gives wide inch threading and feed capabilities with no gear changes
- Independent leadscrew and feed rod
- Spindle actuation control is apron mounted
- Compound and cross slide have backlash adjustment
- Tailstock may be offset for turning tapers and includes an inch/metric graduated quill
- 3-Jaw chuck mounted

STANDARD EQUIPMENT

- 6" 3-jaw direct mount scroll chuck with top reversing jaws
- 8" 4-jaw independent chuck
- 12" faceplate
- Four-way tool post
- Steady and follow rest
- Metric change gear
- Centers with headstock center sleeve
- Threading dial
- Tool box with tools
- Micro carriage bed stop
- Coolant tray
- Tolerance test certificate



STOCK NUMBER	321357A
Model Number	GHB-1340A
Swing over Bed (in.)	13
Swing over Cross Slide (in.)	7-25/32
Swing Through Gap (in.)	18-3/4
Length of Gap (in.)	8
Distance Between Centers (in.)	40
Spindle Bore (in.)	1-3/8
Spindle Mount	D1-4
Spindle Taper (w / sleeve)	MT-5 (MT-3)
Number of Spindle Speeds	8
Range of Spindle Speeds (rpm)	70 - 2,000
Number of Longitudinal and Cross Feed Rates	40
Range of Longitudinal Feeds (ipr)	0.0018 - 0.0374
Range of Cross Feeds (ipr)	0.0006 - 0.0130
Number of inch Threads	38
Range of inch Threads (tpi)	3-1/2 - 80
Number of Metric Threads	23
Range of Metric Threads	0.45 - 10
Max Tool Size (in.)	5/8 x 5/8
Compound Slide Travel (in.)	2-11/16
Cross Slide Travel (in.)	6-5/16
Carriage Travel (in.)	35
Tailstock Spindle Travel (in.)	3-3/4
Taper in Tailstock Spindle	MT-3
Steady Rest Capacity (in.)	2-5/8
Follow Rest Capacity (in.)	2-3/4
Width of Bed (in.)	7-3/8
Overall Dimensions (L x W x H / in.)	79 x 28-1/2 x 30
Motor (HP)	2HP, 1Ph, 230V
Net Weight (lbs.)	1,154

OPTIONAL EQUIPMENT	STOCK NUMBER
Taper Attachment	321442
Collet Closer	321514A

13" GEARED HEAD BENCH LATHE PACKAGES	
321101AK	GHB-1340A with CBS-1340A Stand
321119	GHB-1340A with Taper Attachment
321124	GHB-1340A with Collet Closer
321129	GHB-1340A with Collet Closer and Taper Attachment
321103	GHB-1340A with ACU-RITE VUE DRO
321103AK	GHB-1340A with ACU-RITE VUE DRO and CBS-1340A Stand
321102	GHB-1340A with ACU-RITE VUE DRO with Collet Closer
321226	GHB-1340A with ACU-RITE VUE DRO with Taper Attachment and Collet Closer
321122	GHB-1340A with ACU-RITE 200S DRO
321123	GHB-1340A with ACU-RITE 200S DRO and Taper Attachment
321125	GHB-1340A with ACU-RITE 200S DRO and Collet Closer
321127	GHB-1340A with ACU-RITE 200S DRO with Taper Attachment and Collet Closer
323131	GHB-1340A Lathe with Newall DP500 DRO
323115	GHB-1340A Lathe with Newall DP500 DRO with Taper Attachment
323581	GHB-1340A Lathe with Newall DP500 DRO with Collet Closer
323104	GHB-1340A Lathe with Newall DP500 DRO with Taper Attachment and Collet Closer
321131	GHB-1340A with Newall DP700 DRO
321115	GHB-1340A with Newall DP700 DRO with Taper Attachment
321581	GHB-1340A with Newall DP700 DRO with Collet Closer
321104	GHB-1340A with Newall DP700 DRO with Taper Attachment and Collet Closer

13" x 40" BELT DRIVE BENCH LATHE



Shown with optional stand

DURABILITY

- V-way bed is induction hardened and ground
- Gap bed section provided for large diameter work
- Spindle is supported by precision tapered roller bearings
- Helical cut headstock gears reduce noise

SAFETY

- E-Stop on headstock
- Full length splash guard
- Low voltage motor controls

EASE OF USE

- Enclosed gearbox design provides smooth, quiet operation
- Fast, easy speed changes
- Micro Carriage bed stop
- Threading dial
- Changes gears allow metric threading
- Independent leadscrew and feed rod
- T-slotted compound slide with four-way tool post
- Carriage mounted spindle control lever
- Automatic feeding and threading are fully interlocked
- Tailstock may be offset for turning tapers and includes an inch/metric graduated quill

STANDARD EQUIPMENT

- 6" 3-jaw direct mount scroll chuck with top reversing jaws
- 8" 4-jaw independent chuck
- 12" faceplate
- Four-way tool post
- Steady and follow rest
- Metric change gear
- Centers with headstock center sleeve
- Tool box with tools



STOCK NUMBER	321360A
Model Number	BDB-1340A
Swing over Bed (in.)	13
Swing over Cross Slide (in.)	7-25/32
Swing Through Gap (in.)	18-3/4
Length of Gap (in.)	8
Distance Between Centers (in.)	40
Spindle Bore (in.)	1-3/8
Spindle Mount	D1-4
Spindle Taper (w / sleeve)	MT-5 (MT-3)
Number of Spindle Speeds	12
Range of Spindle Speeds (rpm)	60 - 1,240
Number of Longitudinal and Cross Feed Rates	40
Range of Longitudinal Feeds (ipr)	.0018 - .0374
Range of Cross Feeds (ipr)	.0012 - .0345
Number of inch Threads	40
Range of inch Threads (tpi)	4-112
Number of Metric Threads	27
Range of Metric Threads	0.2-6
Max Tool Size (in.)	5/8 x 5/8
Compound Slide Travel (in.)	2-11/16
Cross Slide Travel (in.)	6-5/16
Carriage Travel (in.)	35
Tailstock Spindle Travel (in.)	3-3/4
Taper in Tailstock Spindle	MT-3
Steady Rest Capacity (in.)	2-5/8
Follow Rest Capacity (in.)	2-3/4
Width of Bed (in.)	7-3/8
Overall Dimensions (L x W x H / in.)	71 x 32 x 45 with Stand
Motor (HP)	2HP, 1Ph, 230V
Net Weight (lbs.)	1170

13" BELT DRIVE BENCH LATHE PACKAGES	
321102AK	BDB-1340A with CBS-1340A Stand
321120	BDB-1340A with Taper Attachment
321111	BDB-1340A with Collet Closer
321112	BDB-1340A, with Taper Attachment and Collet Closer
321110	BDB-1340A with ACU-RITE VUE DRO
321108	BDB-1340A with ACU-RITE VUE DRO with Collet Closer
321121	BDB-1340A with ACU-RITE 200S DRO
321130	BDB-1340A with Newall DP700 DRO
323130	BDB-1340A Lathe with Newall DP500 DRO

TOOL POST SETS

QUICK CHANGE TOOL POST SETS

- #1 Boring & Facing
- #2 Boring, Turning & Facing
- #4 Boring, Heavy-duty
- #7 Universal Parting Blade
- #10 Knurling, Facing & Turning
- Working parts hardened and ground
- Maximum rigidity for chatter-free performance
- Holders fit Aloris and YUASA tool posts
- Increases productivity of all lathe operations
- Completely sealed for maintenance free operation
- Change tools in seconds
- Base must be machined to fit your lathe. For JET Lathes see chart below for specifications

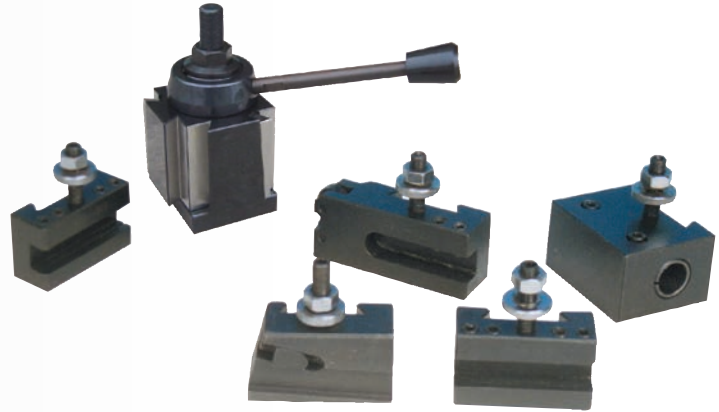

STOCK NUMBER	A	B	C	D	E	F	G
BDB1340A	1.26	1.378	0.315	2	0.63	1.417	0.787
GHB1340A	1.26	1.378	0.315	2	0.63	1.417	0.787
GH1340W	1.375	1.5	0.335	2	0.689	1.708	0.708
GH1440W	1.375	1.5	0.335	2	0.689	1.708	0.708
GH1440ZX, GH1460ZX	1.375	1.5	0.5	1.968	1.125	1.63	0.63
GH1640ZX, GH1660ZX	1.375	1.968	0.5	1.968	1.125	1.87	0.866
GH1840ZX, GH1860ZX, GH1880ZX	1.375	1.968	0.5	1.968	1.125	1.87	0.866
GH2280ZX	1.375	2.75	0.5	1.968	1.125	1.87	0.866

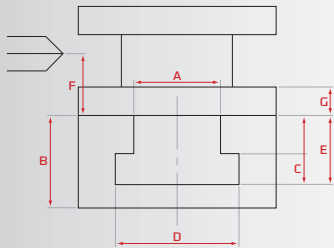

Dimensions for Machining your Tool Post to fit your JET Lathe. Distance for Tool post size on all JET metal lathes.

STOCK NUMBER	650295	650300	650305
Series	200 (BXA)	300 (CXA)	400 (CA)
Fits Swing Lathe Size (in.)	10 - 15	10 - 18	14 - 20
Net Weight (lbs.)	6	6	7



SUPER-PRECISION SETS

ALORIS SUPER-PRECISION INTRO-PRO SETS

Precision-engineered to ensure repetitive accuracy. Advanced design provides built-in quick tool changing, versatility with positive rigidity to meet the most exacting working tolerances. Quickly and easily installed on any engine lathe, bench or CNC lathe for a wide range of operations - from fine precision work to heavy-duty cutting.

The deluxe, affordable beginner's set built by the world's #1 quick change tool post manufacturer.

INTRO-PRO SET (INCLUDES ONE EACH):

- Super precision tool post
- #1 Tool holder
- #2 Tool holder

TURNING AND FACING HOLDER:

- Takes various sizes of bits
- Turning and facing tools can be locked in together
- Saves time and labor when changing operations

BORING, TURNING AND FACING HOLDER:

- "V" groove holds round shank boring bars and tools as well as square tool bits



STOCK NUMBER	650295
650270	BXA Aloris Intro Set for 14" ZX Lathes
650275	CXA Aloris Intro Set for 16" ZX Lathes
650280	CA Aloris Intro Set for 18" ZX Lathes
650285	CA Aloris Intro Set for 22" ZX Lathes
650290	DA Aloris Intro Set for 26" ZH Lathes



TOOL KITS

22-PIECE TURNING TOOL KIT FOR 13" & 14" W SERIES & BENCH SERIES LATHES

- Three double ended boring bars
- Parting tool holder
- Adjustable turning tool holder
- Revolving knurling tool with three pairs of knurls
- Half dead center
- Carbide tipped dead center
- Heavy-duty live center
- Cut off tool
- Eight HSS tool bits
- Four hex key wrenches
- Works with 13" and 14" W Series and Bench Series Lathes



23-PIECE TURNING TOOL KIT FOR ALL ZX SERIES LATHES

- Three double ended boring bars
- Parting tool holder
- Adjustable turning tool holder
- Revolving knurling tool with three pairs of knurls
- Half dead center
- Carbide tipped dead center
- Heavy-duty live center
- Cut off tool
- Eight HSS tool bits
- Four hex key wrenches
- Works with all ZX Series Lathes



TOOLING KIT FOR BD-920W QUICK CHANGE TOOL POST WITH 4 HOLDERS

- MT2 live centers
- 2pc indexable turning tool right & left hand
- Boring tool
- HSS internal threading tool
- Parting tool holder w/HSS blade
- HSS parting blade
- Works with the BD-920W lathe



STOCK NUMBER	DESCRIPTION
660200	22-piece Turning Tool Kit for 13" & 14" W Series & Bench Series Lathes
660210	23-piece Turning Tool Kit for all ZX Series Lathes
660215	Tooling kit for BD-920W



ACCESSORIES

COLLET CLOSER

- Specially designed for each model
- Precision ground components
- Uses 5C collets
- Rear mounted lever action
- Some drilling and other modification may be required

STOCK NUMBER	MODEL NUMBER
321515A	BDB-1340A
321514A	GHB-1340A
321519	All W models
321292	All ZX models



5-C COLLET SETS

- Precision hardened and ground
- C Collets for use on lathes
- Premium collets with 0.0005mm T.I.R

STOCK NUMBER	DESCRIPTION
650014	CS-5C 16 pcs 5-C collet set 1/8" to 1 1/16" by 1/16th



COOLANT SYSTEM

- For use with BDB-1340, GHB-1340 & GHB 1440
- 1/8 HP, 115V 3 gallon per minute flow rate
- Requires drilling of chip pan

STOCK NUMBER	DESCRIPTION
321444	CP-13BD, Coolant Pump Kit for 321357A and 321360A



TAPER ATTACHMENTS

- Specially designed for each model
- 10° inclusive cutting capacity
- Mounts to predrilled and tapped holes
- Factory installation available

STOCK NUMBER	MODEL NUMBER	MAX. TAPER LENGTH (in.) AT 10° ANGLE
321442	BDB-1340A	10
321442	GHB-1340A	10
321520	All W models	10-5/8
321291	All ZX models	18

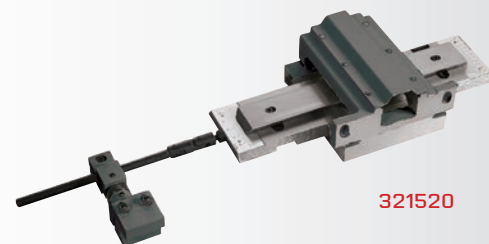

DIGITAL READOUTS

VUE ACU-RITE DRO SERIES

The Acu-Rite VUE is a cost-effective, entry-level solution for manual machine tool applications. With our innovative LCD display screen technology and versatile software to accommodate milling, turning or grinding applications the VUE is everything you need at a price you can afford.

- 1, 2 Or 3 axis 5.7" Transmissive LCD display
- Instant radius/diameter conversion
- Help function
- Instant radius/diameter conversion establish tool offsets with the tool under load, resulting in reduced tool deflection.
- 16 Tool offsets/diameter
- Instant radius/diameter conversion
- Preset and zero reset
- Lock axis feature — used in conjunction with tool offsetting, lets you establish tool offsets with the tool under load, resulting in reduced tool deflection.

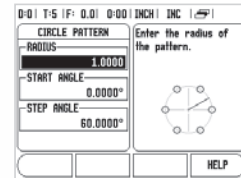

200S ACU-RITE DRO SERIES

As the industry standard in digital readout systems, the Acu-Rite 200S offers state-of-the-art features for milling, turning and grinding applications.

- 2 or 3 axes 5.7" transmissive LCD display
- Position-Trac™ home reference
- Job clock
- Feed rate display
- Lock axis feature
- Instant radius/diameter conversion
- Taper calculator
- CSS (option)

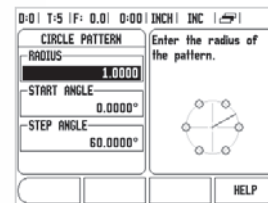
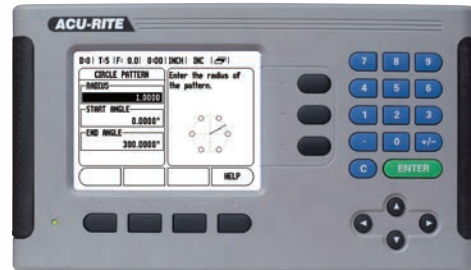

300S ACU-RITE DRO SERIES

The Acu-Rite 300S is a fully programmable 4 axes readout system, now available with a full color display. With the capability to store and create a library of programs the 300S is everything you need to create, edit and execute programs on your manual machine tool..

- 2, 3 or 4 axes 5.7" full color display
- Position-Trac™ home reference
- Multiple program names with numerous steps
- Job clock
- Feed rate display
- Lock axis feature
- Instant radius/diameter conversion
- Taper calculator

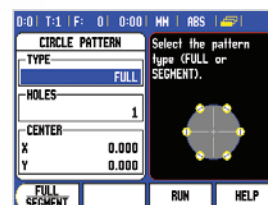
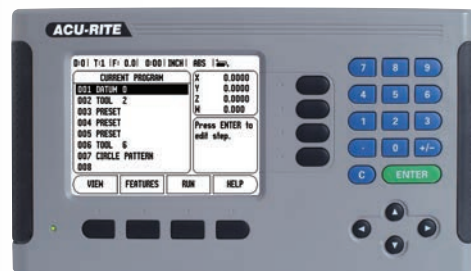

DIGITAL READOUTS

DP700 NEWALL DIGITAL READOUT

The DP700 leads our Newall line of a powerful and intuitive DROs. The unit is housed in a rugged, ergonomically designed casting. The DRO features all of the essential functions for milling, boring, turning, grinding, and general machining operations. The DP700 is compatible with Newall's Spherosyn and Microsyn encoders which withstand the harshest shop conditions.

- Feed rate display
- Bolt hole circle routine
- Line hole routine
- Arc contouring
- Programmable memory/teach
- Polar coordinates
- Line hole calculator
- Tool offsets
- Taper calculations
- Axis vectoring/summing
- Linear and segmented error comp.
- Undo
- RS232 output
- Languages: English, French, German, Spanish, Italian, Turkish, Czech, Russian, Portuguese, Danish
- Clean, crisp, easy-to-read, LEDs
- Intuitive message window
- Long life membrane keypad
- Solid cast construction
- Safe, low voltage power supply (UL)
- Panel mount version available

NEWALL



DP500 NEWALL DIGITAL READOUT

The DP500 is the newest addition to the Newall DRO family. The DP500 comes equipped with Digifind, a feature unique to Newall digital readout products. Digifind eliminates the risk of losing your position and datum Set-Up. With Digifind, precise Setup of a workpiece is carried out only one time.

- Absolute/incremental readings
- Inch/metric instant conversion
- Switchable resolutions
- Center find
- Radius/diameter readings
- Datum preset/zero reset
- Bolt hole circle
- Tool offsets
- Segmented error compensation
- Linear error compensation
- Reference point (Digifind)
- Languages: English, French, German, Spanish, Italian, Turkish, Czech, Russian, Portuguese, Danish



The DP500 Packages come with the new Spherosyn LT or Microsyn LT encoders. These encoders feature the same inductive technology and IP67 rating as Newall's Spherosyn 2G encoders and will provide accurate and dependable readings under the harshest environmental conditions.





MILLING

JET Milling machines and components are manufactured to deliver precision cuts job after job. Industry professionals know JET Step Pulley, Variable Speed and CNC Mills provide the reliability and flexibility to keep even the busiest shops up and running, with superior results on every part turned out. Clearly-written, professional manuals get you started with ease, and every JET Mill is backed by our industry-leading Two Year Warranty. Precise, Efficient & Accurate. To Fit Your Shop's Needs.



CHOOSE YOUR MILL

QUICK REFERENCE GUIDE

BASE MACHINE	MODEL NUMBER	TABLE SIZE (in.)	DRIVE TYPE	SPINDLE TAPER	QUILL DIAMETER (in.)	MOTOR (HP)	PAGE NUMBER
ELECTRONIC VARIABLE SPEED VERTICAL MILL							
690601	JTM-1050EVS2	10 x 50	EVS	R8	3-3/8	3 HP, 230V, 3Ph	74
691501	JTM-949EVS	9 x 49	EVS	R-8	3-3/8	3HP, 230V, 3Ph	74
VS VARIABLE SPEED VERTICAL MILL							
NEW	690020	JTM-1254RVS	Variable Speed	R-8	3-3/8	5HP, 230/460V, 3Ph	68
NEW	690025	JTM-1254VS	Variable Speed	NST-40	4-1/8	5HP, 230/460V, 3Ph	68
	690050	JTM-1050	Variable Speed	R-8	3-3/8	3HP, 230/460V, 3Ph,	72
	690182	JTM-4VS	Variable Speed	R-8	3-3/8	3 HP, 230/460V, 3Ph	78
	690180	JTM-4VS-1	Variable Speed	R-8	3-3/8	2 HP, 115/230V, 1Ph	78
STEP PULLEY VERTICAL MILL							
	690082	JTM-1	Step Pulley	R-8	3-3/8	2 HP, 230V, 3Ph	82
	690089	JTM-2	Step Pulley	R-8	3-3/8	2 HP, 115/230V, 1Ph	82
	690038	JVM-836-3	Step Pulley	R-8	3-3/8	1-1/2 HP, 230V, 3Ph	84
	690036	JVM-836-1	Step Pulley	R-8	3-3/8	1-1/2 HP, 115/230V, 1Ph	84
VARIABLE SPEED MILL DRILL							
NEW	351050	JMD-45VSP	Variable Speed	R-8	3	1.5HP, 115/230V, 60Hz, 1ph	90
NEW	351051	JMD-45VSPFT	Variable Speed	R-8	3	1.5HP, 115/230V, 60Hz, 1ph	90
GEARED HEAD MILL DRILL							
NEW	351040	JMD-40GH	Geared Head	R-8	3	1.5 HP, 115/230V, 1ph,	88
NEW	351041	JMD-40GHPF	Geared Head	R-8	3	1.5 HP, 115/230V, 1ph,	88
NEW	351045	JMD-45GH	Geared Head	R-8	3	1.5 HP, 115/230V, 1ph,	90
NEW	351046	JMD-45GHPF	Geared Head	R-8	3	1.5 HP, 115/230V, 1ph,	90
STEP PULLEY MILL DRILL							
	350020	JMD-18PFN	Step Pulley	R-8	3	2 HP, 230V, 1Ph	86
	350018	JMD-18	Step Pulley	R-8	3	2 HP, 115/230V, 1Ph	86
	350017	JMD-15	Step Pulley	R-8	2-1/2	1 HP, 115/230V, 1Ph	86

*See product pages for package options



MILLING HELPFUL INFO

Milling is the process of machining flat, curved, or irregular surfaces by feeding the workpiece against a rotating cutter containing a number of cutting edges. The mill consists basically of a motor driven spindle, which mounts and revolves the milling cutter, and a reciprocating adjustable worktable, which mounts and feeds the workpiece. The milling machine is excellent for forming flat surfaces, cutting dovetails and keyways, forming and fluting milling cutters and reamers, cutting gears, and so forth.

Most milling machines have self contained electric drive motors, coolant systems, step pulley or variable spindle speeds, and power operated table feeds.

Knee type mills are characterized by a vertical adjustable worktable resting on a saddle which is supported by a knee. The knee is a massive casting that rides vertically on the milling machine column and can be clamped rigidly to the column in a position where the milling head and milling machine spindle are properly adjusted vertically for operation.

The turret and swivel head assembly is designed for making precision cuts and can be swung 360 degrees on its base. Angular cuts to the horizontal plane may be made with precision by setting the head at any required angle within the 180 degree arc.

The knee is used for raising and lowering. The saddle rests upon the knee and supports the worktable. The saddle moves in and out on a dovetail to control the crossfeed of the worktable. The worktable traverses to the right or left upon the saddle for feeding the workpiece past the milling cutter. Many special operations can be performed with the attachments available for milling machine use.

JET Milling Machines are precision-built and designed to last. We have a full range of machines from Mill Drills, Step Pulley to Variable Speed models. All of JET's production mills are made with a Meehanite® casting and has it proudly stamped on the front of our machine! JET offers both R8 and NST-40 mills. JET will be happy to build your mill anyway you want it. JET installs Retrofit Acu-Rite MILLPWR controls is 2 or 3 axis, 2 or 3 Axis DRO's, Table or Knee Powerfeeds, Air Powered Draw Bars, Riser blocks for most models. If you do not see the package you need just give us a call.

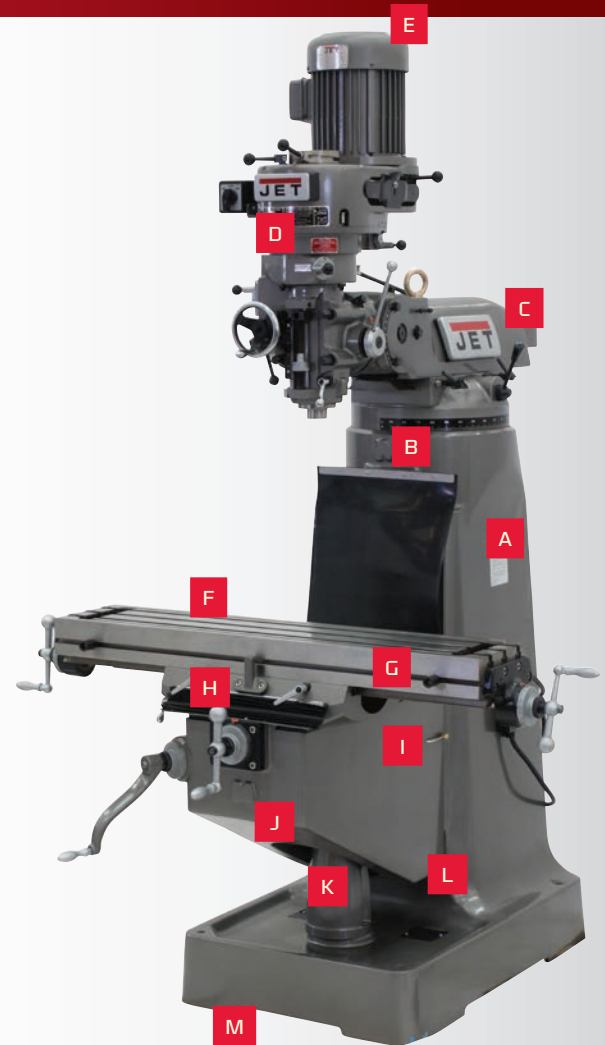

COMMON MILL TERMINOLOGY

- | | | |
|---------------------------------|---|-------------------------------------|
| A COLUMN | F HARDENED AND GROUND TABLE | J KNEE |
| B MEEHANITE® CASTING | G LOCKS ON ALL MOVEABLE SURFACES | K INTERNAL COOLANT TANK |
| C RAM | H SADDLE | L VERTICAL POSITIONING SCREW |
| D VERTICAL HEAD | I WAYS | M BASE |
| E HEAVY-DUTY MOTOR DRIVE | | |

CNC VERTICAL MILLING MACHINE PACKAGES



FEATURES OF THE ACU-RITE MILLPWR G2® 2- OR 3-AXIS CONTROL

- USB and Ethernet compatible
- Simplified navigation that eliminates multiple menu screens
- Bolthole calculations, calculate bolthole patterns instantly
- Expanded tool and datum offsets
- Jog control, move quickly from one location to another—using one axis at a time or any two axes simultaneously
- 3-D contouring, ability to import and run G-code files from CAD/CAM programs
- Mirror/Repeat/Rotate easily manipulate part programs to save time and reduce program steps.
- 12.1" flat panel, vivid, color, LCD display to view immediate graphic feedback
- Menu-prompted conversational programming, easily create part programs, edit, reverse, change, delete and copy/move steps—follow the menu prompts and let MILLPWR G2® do the rest
- Estimated runtime feature assists in increases mill productivity and efficiency
- Built-in calculator, perform standard, trig and geometry calculations and transfer them directly into part programs

690675



STOCK NUMBER	690182	690180	690501	690050	690601	690025	690020
Model Number	JTM-4VSCNC	JTM-4VS-1 CNC	JTM-949EVSCNC	JTM-1050CNC	JTM-1050EVS2CNC	JTM-1254VS	JTM-1254RVS
Table Size (in.)	9 x 49	9 x 49	9 x 49	10 x 50	10 x 50	12 x 54	12 x 54
2-Axis CNC	690938		690575	690930	690675	691940	691943
2Axis with Air Power Drawbar					690685		
3-Axis CNC	690948	690950	690576	690940	690676	691941	691944
3-Axis with Air Power Drawbar	690949					691942	691945
Spindle Taper	R-8	R-8	R-8	R-8	R-8	NT40	R-8
Quill Diameter (in.)	3-3/8	3-3/8	3-3/8	3-3/8	3-3/8	4-1/8	3-3/8
Number of Spindle Speeds	Variable	Variable	Variable	Variable	Variable	Variable	Variable
Range of Spindle Speeds (rpm)	60 - 4,200	60 - 4,200	60 - 4,500	70 - 3,800	10 - 3,600	80 - 3,800	80 - 3,800
Quill Down Feed Rates (ipr)	.0015 - .003 - .006	.0015 - .003 - .006	.0015 - .003 - .006	.0015 - .003 - .006	.0015 - .003 - .006	.0015-.003-.008	.0015-.003-.006
Spindle Travel (in.)	5	5	5	5	5	5	5
Head Movement (deg.)	90° R & L, 45° F & B	90° R & L, 45° F & B	90° R & L, 45° F & B	90° R & L, 45° F & B	90° R & L, 45° F & B	90°R & L	90°R & L / 45° F & B
Max Distance Spindle to Table (in.)	17-1/2	17-1/2	20-3/4	19	19	23	23
Distance Spindle to Column (max. / in.)	19	19	18-1/8	26	26	26-1/2	26-1/2
Distance Spindle to Column (min. / in.)	4-1/2	4-1/2	4-3/4	5-1/2	5-1/2	7-1/2	7-1/2
Collet Capacity	1/8 - 7/8	1/8 - 7/8	1/8 - 7/8	1/8 - 7/8	1/8 - 7/8	1/8-1	1/8 - 1
Table Longitudinal Travel (in.)	34	34	30-3/4	30	30	33-7/8	33-7/8
Table Cross Travel (in.)	12	12	12-5/8	15-1/4	15-1/4	15-1/3	15-1/3
T-Slot Centers (in.)	2-1/2	2-1/2	2-1/2	2-1/2	2-1/2	2-1/2	2-1/2
Work Table Weight Capacity (lbs.)	660	660	720	720	720	925	925
Travel of Knee (in.)	14-1/2	14-1/2	15-3/4	14-1/4	14-1/4	19-1/4	19-1/4
Travel of Ram (in.)	13-3/8	13-3/8	15-1/4	20-1/2	20-1/2	20.4	20.4
Column Width (in.)						14-1/4	14-1/4
Motor (HP)	3HP, 230/460V, 3Ph, Prewired 230V	3HP, 230/460V, 3Ph, Prewired 230V	3HP, 230V , 3Ph	3HP, 230/460V, 3Ph, Prewired 230V	3HP, 230V Only, 3Ph	5HP, 230/460V, 3Ph	5HP, 230/460V, 3Ph
Prewired	230V	230V	230V	230V	230V	230V, 3Ph	230V, 3Ph
Overall Dimensions (L x W x H / in.)	66 x 63 x 85	66 x 63 x 85	67 x 64 x 86	96 x 69 x 87	96 x 71 x 88	92-1/8 x 79-7/8 x 104-1/4	92-1/8 x 79-7/8 x 104-1/4
Net Weight (lbs.)	2,420	2,420	2,420	3,200	3,000	3,260	3,260
Gross Weight (lbs.)	2,520	2,520	2,520	3,300	3,100	3,696	3,696

**For Mill features and specs, see Mill pages.

Call Customer Service at 888-804-7129 for additional packages or visit www.jettools.com to Custom Build your own Package.

NEW

JTM-1254RV AND JTM-1254RVS VARIABLE SPEED MILLING MACHINES



690025

DURABILITY

- Meehanite® castings
- Precision honed and bored milling head
- High precision class 7 spindle bearings
- Quick spindle feed nut
- Three-stage power downfeed with automatic stop
- Heavy-duty spindle brake
- Precision hardened and ground ways and table
- Three precision ground t-slots
- Turcite B on X & Y Axis
- Adjustable gibs throughout

SAFETY

- CSA/CUS: Following strict guidelines and electrical requirements, these JET Mills are CSA/CUS certified
- Spindle guard
- Spindle brake for rapid stopping of the spindle

EASE OF USE

- Automatic lubrication every 180 minutes with a flow of 3-6cc reduces maintenance
- Quick nut for spindle feed
- JET exclusive new casting provides the end-user an easier solution to leveling the machine without raising it up off the floor
- Two 115V outlets on electrical box for powerfeeds only

OPTIONAL EXTERNAL COOLANT SYSTEM

- Add the 660126 External Coolant System which fits at the bottom of the base. It can be installed to work off a switch on the control arm precise drilling.



STOCK NUMBER	690025	690020
Model Number	JTM-1254VS	JTM-1254RVS
Table Size (in.)	12 x 54	12 x 54
Spindle Taper	NT40	R-8
Quill Diameter (in.)	4-1/8	3-3/8
Number of Spindle speeds	Variable	Variable
Range of Spindle Speeds (rpm)	80 - 3,800	80 - 3,800
Quill Down feed Rates (ipr)	.0015-.003-.008	.0015-.003-.006
Spindle/Quill Travel (in.)	5	5
Head Movement (deg.)	90°R & L	90°R & L / 45° F & B
Max Distance Spindle to Table (in.)	23	23
Distance Spindle to Column (max. / in.)	26-1/2	26-1/2
Distance Spindle to Column (min. / in.)	7-1/2	7-1/2
Collet Capacity (in.)	1/8 - 1	1/8 - 1
Table Longitudinal Travel (range / in.) (thru saddle)	33-7/8	27-4/5
Table Cross Travel (in.)	15-1/3	15-1/3
T-Slots Number and Size (in.)	3 and 5/8	3 and 5/8
T-Slot Centers (in.)	2-1/2	2-1/2
Work Table Weight Capacity (lbs.)	925	925
Travel of Knee (in.)	19-1/4	19-1/4
Travel of Ram (in.) (over turret)	20.4	20.4
Saddle Width (in.)	25-5/8	25-5/8
WAYS:		
X- Axis	Dovetail	Dovetail
Y- Axis	Square	Square
Z- Axis	Square	Square
Column Width (in.)	14-1/4	14-1/4
Motor TEFC (HP)	5HP, 230/460V, 3Ph	5HP, 230/460V, 3Ph
Prewired	230V, 3Ph	230V, 3Ph
Net Weight (lbs.)	3260	3260
Gross Weight (lbs.)	3696	3696
OPTIONAL EQUIPMENT		
External Coolant Pump Assembly	660126	660126
Milling Chuck Kit	-	466001
Milling Vise - Wilton Verti-Lock	63186	63186

Call Customer Service at 888-804-7129 for additional packages or visit www.jetttools.com to Custom Build your own Package.

JTM-1254VS MILLING PACKAGES

STOCK NUMBER	DESCRIPTION
690025	JTM-1254VS 12x54 NT40 VS MILL 230/460V
691940	JTM-1254VS 2-Axis with ACU-RITE G-2 MILPWR CNC
691941	JTM-1254VS 3-Axis with ACU-RITE G-2 MILPWR CNC
691942	JTM-1254VS 3-Axis with MILPWR CNC & Air Power Drawbar
698025	JTM-1254VS with X Powerfeed
698026	JTM-1254VS with X Powerfeed & Air Power Drawbar
698027	JTM-1254VS with X & Y Powerfeeds
698028	JTM-1254VS with X & Y Powerfeeds & Air Power Drawbar
698029	JTM-1254VS with X,Y & Z Powerfeeds
698030	JTM-1254VS with X,Y & Z Powerfeeds & Air Power Drawbar
698031	JTM-1254VS with ACU-RITE VUE DRO, X Powerfeed
698032	JTM-1254VS with ACU-RITE VUE DRO, X Powerfeed & Air Power Drawbar
698033	JTM-1254VS with ACU-RITE VUE DRO X & Y Powerfeeds
698034	JTM-1254VS with ACU-RITE VUE DRO X & Y Powerfeeds & Air Power Drawbar
698035	JTM-1254VS with ACU-RITE VUE DRO X,Y & Z Powerfeeds
698036	JTM-1254VS with ACU-RITE VUE DRO X,Y & Z Powerfeeds & Air Power Drawbar
698037	JTM-1254VS with ACU-RITE VUE 3X (K) DRO & X Powerfeed
698038	JTM-1254VS with ACU-RITE VUE 3X (K) DRO & X Powerfeed & Air Power Drawbar
698039	JTM-1254VS with ACU-RITE VUE 3X (K) DRO, X & Y Powerfeeds
698040	JTM-1254VS with ACU-RITE VUE 3X (K) DRO, X & Y Powerfeeds & Air Power Drawbar
698041	JTM-1254VS with ACU-RITE VUE 3X (K) DRO, X, Y & Z Powerfeeds
698042	JTM-1254VS with ACU-RITE VUE 3X (K) DRO, X, Y & Z Powerfeeds & Air Power Drawbar
698043	JTM-1254VS with ACU-RITE VUE 3X (Q) DRO & X Powerfeed
698044	JTM-1254VS with ACU-RITE VUE 3X (Q) DRO & X Powerfeed & Air Power Drawbar
698045	JTM-1254VS with ACU-RITE VUE 3X (Q) DRO, X & Y Powerfeeds
698046	JTM-1254VS with ACU-RITE VUE 3X (Q) DRO, X & Y Powerfeeds & Air Power Drawbar
698047	JTM-1254VS with ACU-RITE VUE 3X (Q) DRO, X, Y & Z Powerfeeds
698048	JTM-1254VS with ACU-RITE VUE 3X (Q) DRO, X, Y & Z Powerfeeds & Air Power Drawbar
698049	JTM-1254VS with ACU-RITE 200S DRO, X Powerfeed
698050	JTM-1254VS with ACU-RITE 200S DRO, X Powerfeed & Air Power Drawbar
698051	JTM-1254VS with ACU-RITE 200S DRO X & Y Powerfeeds
698052	JTM-1254VS with ACU-RITE 200S DRO X & Y Powerfeeds & Air Power Drawbar
698053	JTM-1254VS with ACU-RITE 200S DRO X, Y & Z Powerfeeds
698054	JTM-1254VS with ACU-RITE 200S DRO X, Y & Z Powerfeeds & Air Power Drawbar
698055	JTM-1254VS with ACU-RITE 200S 3X (K) DRO & X Powerfeed
698056	JTM-1254VS with ACU-RITE 200S 3X (K) DRO, X Powerfeed & Air Power Drawbar
698057	JTM-1254VS with ACU-RITE 200S 3X (K) DRO, X & Y Powerfeeds
698058	JTM-1254VS with ACU-RITE 200S 3X (K) DRO, X & Y Powerfeeds & Air Power Drawbar
698059	JTM-1254VS with ACU-RITE 200S 3X (K) DRO, X, Y & Z Powerfeeds
698060	JTM-1254VS with ACU-RITE 200S 3X (K) DRO, X, Y & Z Powerfeeds & Air Power Drawbar
698061	JTM-1254VS with ACU-RITE 200S 3X (Q) DRO & X Powerfeed

STOCK NUMBER	DESCRIPTION
698062	JTM-1254VS with ACU-RITE 200S 3X (Q) DRO, X Powerfeed & Air Power Drawbar
698063	JTM-1254VS with ACU-RITE 200S 3X (Q) DRO, X & Y Powerfeeds
698064	JTM-1254VS with ACU-RITE 200S 3X (Q) DRO, X & Y Powerfeeds & Air Power Drawbar
698065	JTM-1254VS with ACU-RITE 200S 3X (Q) DRO, X, Y & Z Powerfeeds
698066	JTM-1254VS with ACU-RITE 200S 3X (Q) DRO, X, Y & Z Powerfeeds & Air Power Drawbar
698067	JTM-1254VS with Newall DP700 DRO & X Powerfeed
698068	JTM-1254VS with Newall DP700 DRO X Powerfeed & Air Power Drawbar
698069	JTM-1254VS with Newall DP700 DRO X & Y Powerfeeds
698070	JTM-1254VS with Newall DP700 DRO X & Y Powerfeeds & Air Power Drawbar
698071	JTM-1254VS with Newall DP700 DRO X, Y & Z Powerfeeds
698072	JTM-1254VS with Newall DP700 DRO X, Y & Z Powerfeeds & Air Power Drawbar
698144	JTM-1254VS with Newall DP700 3X (K) DRO, X Powerfeed
698073	JTM-1254VS with Newall DP700 3X (K) DRO, X Powerfeed & Air Power Drawbar
698074	JTM-1254VS with Newall DP700 3X (K) DRO, X & Y Powerfeeds
698075	JTM-1254VS with Newall DP700 3X (K) DRO, X & Y Powerfeeds & Air Power Drawbar
698076	JTM-1254VS with Newall DP700 3X (K) DRO, X, Y & Z Powerfeeds
698077	JTM-1254VS with Newall DP700 3X (K) DRO, X, Y & Z Powerfeeds & Air Power Drawbar
698078	JTM-1254VS with Newall DP700 3X (Q) DRO & X Powerfeed
698079	JTM-1254VS with Newall DP700 3X (Q) DRO, X Powerfeed & Air Power Drawbar
698080	JTM-1254VS with Newall DP700 3X (Q) DRO, X & Y Powerfeeds
698081	JTM-1254VS with Newall DP700 3X (Q) DRO, X & Y Powerfeeds & Air Power Drawbar
698082	JTM-1254VS with Newall DP700 3X (Q) DRO, X, Y & Z Powerfeeds
698083	JTM-1254VS with Newall DP700 3X (Q) DRO, X, Y & Z Powerfeeds & Air Power Drawbar
698146	JTM-1254VS with ACU-RITE 300S DRO, X Powerfeed
698147	JTM-1254VS with ACU-RITE 300S DRO, X Powerfeed & Air Power Drawbar
698148	JTM-1254VS with ACU-RITE 300S DRO X & Y Powerfeeds
698149	JTM-1254VS with ACU-RITE 300S DRO X & Y Powerfeeds & Air Power Drawbar
698150	JTM-1254VS with ACU-RITE 300S DRO X, Y & Z Powerfeeds
698151	JTM-1254VS with ACU-RITE 300S DRO X, Y & Z Powerfeeds & Air Power Drawbar
698152	JTM-1254VS with ACU-RITE 300S 3X (K) DRO & X Powerfeed
698153	JTM-1254VS with ACU-RITE 300S 3X (K) DRO, X Powerfeed & Air Power Drawbar
698154	JTM-1254VS with ACU-RITE 300S 3X (K) DRO, X & Y Powerfeeds
698155	JTM-1254VS with ACU-RITE 300S 3X (K) DRO, X & Y Powerfeeds & Air Power Drawbar
698156	JTM-1254VS with ACU-RITE 300S 3X (K) DRO, X, Y & Z Powerfeeds
698157	JTM-1254VS with ACU-RITE 300S 3X (K) DRO, X, Y & Z Powerfeeds & Air Power Drawbar
698158	JTM-1254VS with ACU-RITE 300S 3X (Q) DRO & X Powerfeed
698159	JTM-1254VS with ACU-RITE 300S 3X (Q) DRO, X Powerfeed & Air Power Drawbar
698160	JTM-1254VS with ACU-RITE 300S 3X (Q) DRO, X & Y Powerfeeds
698161	JTM-1254VS with ACU-RITE 300S 3X (Q) DRO, X & Y Powerfeeds & Air Power Drawbar
698162	JTM-1254VS with ACU-RITE 300S 3X (Q) DRO, X, Y & Z Powerfeeds
698163	JTM-1254VS with ACU-RITE 300S 3X (Q) DRO, X, Y & Z Powerfeeds & Air Power Drawbar

Call Customer Service at 888-804-7129 for additional packages or visit www.jettools.com to Custom Build your own Package.

JTM-1254RVS

MILLING PACKAGES

STOCK NUMBER	DESCRIPTION
691943	JTM-1254RVS 2-Axis with ACU-RITE G-2 MILPWR CNC
691944	JTM-1254RVS 3-Axis with ACU-RITE G-2 MILPWR CNC
691945	JTM-1254RVS 3-Axis with MILPWR CNC & Air Power Drawbar
690020	JTM-1254RVS 12x54 R8 VS MILL 230/460V,
698084	JTM-1254RVS with X Powerfeed
698085	JTM-1254RVS with X Powerfeed & Air Power Drawbar
698086	JTM-1254RVS with X & Y Powerfeeds
698087	JTM-1254RVS with X & Y Powerfeeds & Air Power Drawbar
698088	JTM-1254RVS with X,Y & Z Powerfeeds
698089	JTM-1254RVS with X,Y & Z Powerfeeds & Air Power Drawbar
698090	JTM-1254RVS with ACU-RITE VUE DRO, X Powerfeed
698091	JTM-1254RVS with ACU-RITE VUE DRO, X Powerfeed & Air Power Drawbar
698092	JTM-1254RVS with ACU-RITE VUE DRO X & Y Powerfeeds
698093	JTM-1254RVS with ACU-RITE VUE DRO X & Y Powerfeeds & Air Power Drawbar
698094	JTM-1254RVS with ACU-RITE VUE DRO X,Y & Z Powerfeeds
698095	JTM-1254RVS with ACU-RITE VUE DRO X,Y & Z Powerfeeds & Air Power Drawbar
698096	JTM-1254RVS with ACU-RITE VUE 3X (K) DRO & X Powerfeed
698097	JTM-1254RVS with ACU-RITE VUE 3X (K) DRO & X Powerfeed & Air Power Drawbar
698098	JTM-1254RVS with ACU-RITE VUE 3X (K) DRO, X & Y Powerfeeds
698099	JTM-1254RVS with ACU-RITE VUE 3X (K) DRO, X & Y Powerfeeds & Air Power Drawbar
698100	JTM-1254RVS with ACU-RITE VUE 3X (K) DRO, X, Y & Z Powerfeeds
698101	JTM-1254RVS with ACU-RITE VUE 3X (K) DRO, X, Y & Z Powerfeeds & Air Power Drawbar
698102	JTM-1254RVS with ACU-RITE VUE 3X (Q) DRO & X Powerfeed
698103	JTM-1254RVS with ACU-RITE VUE 3X (Q) DRO & X Powerfeed & Air Power Drawbar
698104	JTM-1254RVS with ACU-RITE VUE 3X (Q) DRO, X & Y Powerfeeds
698105	JTM-1254RVS with ACU-RITE VUE 3X (Q) DRO, X & Y Powerfeeds & Air Power Drawbar
698106	JTM-1254RVS with ACU-RITE VUE 3X (Q) DRO, X, Y & Z Powerfeeds
698107	JTM-1254RVS with ACU-RITE VUE 3X (Q) DRO, X, Y & Z Powerfeeds & Air Power Drawbar
698108	JTM-1254RVS with ACU-RITE 200S DRO, X Powerfeed
698109	JTM-1254RVS with ACU-RITE 200S DRO, X Powerfeed & Air Power Drawbar
698110	JTM-1254RVS with ACU-RITE 200S DRO X & Y Powerfeeds
698111	JTM-1254RVS with ACU-RITE 200S DRO X & Y Powerfeeds & Air Power Drawbar
698112	JTM-1254RVS with ACU-RITE 200S DRO X, Y & Z Powerfeeds
698113	JTM-1254RVS with ACU-RITE 200S DRO X, Y & Z Powerfeeds & Air Power Drawbar
698114	JTM-1254RVS with ACU-RITE 200S 3X (K) DRO & X Powerfeed
698115	JTM-1254RVS with ACU-RITE 200S 3X (K) DRO, X Powerfeed & Air Power Drawbar
698116	JTM-1254RVS with ACU-RITE 200S 3X (K) DRO, X & Y Powerfeeds
698117	JTM-1254RVS with ACU-RITE 200S 3X (K) DRO, X & Y Powerfeeds & Air Power Drawbar
698118	JTM-1254RVS with ACU-RITE 200S 3X (K) DRO, X, Y & Z Powerfeeds
698119	JTM-1254RVS with ACU-RITE 200S 3X (K) DRO, X, Y & Z Powerfeeds & Air Power Drawbar
698120	JTM-1254RVS with ACU-RITE 200S 3X (Q) DRO & X Powerfeed
698121	JTM-1254RVS with ACU-RITE 200S 3X (Q) DRO, X Powerfeed & Air Power Drawbar
698122	JTM-1254RVS with ACU-RITE 200S 3X (Q) DRO, X & Y Powerfeeds

STOCK NUMBER	DESCRIPTION
698123	JTM-1254RVS with ACU-RITE 200S 3X (Q) DRO, X & Y Powerfeeds & Air Power Drawbar
698124	JTM-1254RVS with ACU-RITE 200S 3X (Q) DRO, X, Y & Z Powerfeeds
698125	JTM-1254RVS with ACU-RITE 200S 3X (Q) DRO, X, Y & Z Powerfeeds & Air Power Drawbar
698126	JTM-1254RVS with Newall DP700 DRO & X Powerfeed
698127	JTM-1254RVS with Newall DP700 DRO X Powerfeed & Air Power Drawbar
698128	JTM-1254RVS with Newall DP700 DRO X & Y Powerfeeds
698129	JTM-1254RVS with Newall DP700 DRO X & Y Powerfeeds & Air Power Drawbar
698130	JTM-1254RVS with Newall DP700 DRO X, Y & Z Powerfeeds
698131	JTM-1254RVS with Newall DP700 DRO X, Y & Z Powerfeeds & Air Power Drawbar
698132	JTM-1254RVS with Newall DP7003X (K) DRO & X Powerfeed
698133	JTM-1254RVS with Newall DP700 3X (K) DRO, X Powerfeed & Air Power Drawbar
698134	JTM-1254RVS with Newall DP700 3X (K) DRO, X & Y Powerfeeds
698135	JTM-1254RVS with Newall DP700 3X (K) DRO, X & Y Powerfeeds & Air Power Drawbar
698136	JTM-1254RVS with Newall DP700 3X (K) DRO, X, Y & Z Powerfeeds
698137	JTM-1254RVS with Newall DP700 3X (K) DRO, X, Y & Z Powerfeeds & Air Power Drawbar
698138	JTM-1254RVS with Newall DP700 3X (Q) DRO & X Powerfeed
698139	JTM-1254RVS with Newall DP700 3X (Q) DRO, X Powerfeed & Air Power Drawbar
698140	JTM-1254RVS with Newall DP700 3X (Q) DRO, X & Y Powerfeeds
698141	JTM-1254RVS with Newall DP700 3X (Q) DRO, X & Y Powerfeeds & Air Power Drawbar
698142	JTM-1254RVS with Newall DP700 3X (Q) DRO, X, Y & Z Powerfeeds
698143	JTM-1254RVS with Newall DP700 3X (Q) DRO, X, Y & Z Powerfeeds & Air Power Drawbar
698164	JTM-1254RVS with ACU-RITE 300S DRO, X Powerfeed
698165	JTM-1254RVS with ACU-RITE 300S DRO, X Powerfeed & Air Power Drawbar
698166	JTM-1254RVS with ACU-RITE 300S DRO X & Y Powerfeeds
698167	JTM-1254RVS with ACU-RITE 300S DRO X & Y Powerfeeds & Air Power Drawbar
698168	JTM-1254RVS with ACU-RITE 300S DRO X, Y & Z Powerfeeds
698169	JTM-1254RVS with ACU-RITE 300S DRO X, Y & Z Powerfeeds & Air Power Drawbar
698170	JTM-1254RVS with ACU-RITE 300S 3X (K) DRO & X Powerfeed
698171	JTM-1254RVS with ACU-RITE 300S 3X (K) DRO, X Powerfeed & Air Power Drawbar
698172	JTM-1254RVS with ACU-RITE 300S 3X (K) DRO, X & Y Powerfeeds
698173	JTM-1254RVS with ACU-RITE 300S 3X (K) DRO, X & Y Powerfeeds & Air Power Drawbar
698174	JTM-1254RVS with ACU-RITE 300S 3X (K) DRO, X, Y & Z Powerfeeds
698175	JTM-1254RVS with ACU-RITE 300S 3X (Q) DRO & X Powerfeed
698176	JTM-1254RVS with ACU-RITE 300S 3X (Q) DRO, X Powerfeed & Air Power Drawbar
698177	JTM-1254RVS with ACU-RITE 300S 3X (Q) DRO, X & Y Powerfeeds
698178	JTM-1254RVS with ACU-RITE 300S 3X (Q) DRO, X & Y Powerfeeds & Air Power Drawbar
698179	JTM-1254RVS with ACU-RITE 300S 3X (Q) DRO, X, Y & Z Powerfeeds
698180	JTM-1254RVS with ACU-RITE 300S 3X (Q) DRO, X, Y & Z Powerfeeds & Air Power Drawbar
698145	JTM-1254RVS with ACU-RITE 300S 3 Axis (K) DRO X, Y & Z Powerfeeds & Air Power Drawbar

JTM-1050

VARIABLE SPEED VERTICAL MILLING MACHINE



DURABILITY

- Meehanite® casting
- Hardened and ground table
- Chrome lead screws on X and Y axis
- Turcite B on X and Y axis
- Precision bored and honed milling head
- High precision Class 7 spindle bearings
- Satin chrome finished dials
- Large diameter quill is chromed
- Heavy-duty motor drive
- Chrome plated motor shaft with bearing support at end

SAFETY

- CSA/CUS: Following strict guidelines and electrical requirements, these JET Mills are CSA/CUS certified
- No fuse breaker power connection
- Heavy-duty spindle brake

EASE OF USE

- One-shot lubrication system
- Spindle head is internally cooled
- One-piece quill pinion and shaft

STANDARD EQUIPMENT

- One-shot lubrication system
- Way covers
- Draw bar
- Tool box with tools



STOCK NUMBER	690050
Model Number	JTM-1050
Table Size (in.)	10 x 50
Spindle Taper	R-8
Quill Diameter (in.)	3-3/8
Number of Spindle Speeds	Variable
Range of Spindle Speeds (rpm)	70 - 3,800
Quill Down Feed Rates (ipr)	.0015 - .003 - .006
Spindle Travel (in.)	5
Head Movement (deg.)	90° R & L, 45° F & B
Max Distance Spindle to Table (in.)	19
Distance Spindle to Column (max. / in.)	26
Distance Spindle to Column (min. / in.)	5-1/2
Collet Capacity	1/8 - 7/8
Table Longitudinal Travel (in.)	30
Table Cross Travel (in.)	15-1/4
T-Slots Number and Size (in.)	3 and 5/8
T-Slot Centers (in.)	2-1/2
Work Table Weight Capacity (lbs.)	720
Travel of Knee (in.)	14-1/4
Travel of Ram (in.)	20-1/2
Motor (HP)	3HP, 230/460V, 3Ph, Prewired 230V
Overall Dimensions (L x W x H / in.)	96 x 78 x 88
Net Weight (lbs.)	2751

JTM-1050 MILL ACCESSORY PACKAGES	
690120	JTM-1050 Mill with X-Axis Powerfeed
690150	JTM-1050 Mill with X & Y-Axis Powerfeeds
690403	JTM-1050 Mill with ACU-RITE VUE DRO with X-Axis Powerfeed
690409	JTM-1050 Mill with ACU-RITE VUE DRO with X & Y-Axis Powerfeed
690117	JTM-1050 Mill with ACU-RITE 200S DRO with X-Axis Powerfeed
690216	JTM-1050 Mill with ACU-RITE 200S DRO with X-Axis Powerfeed & 8" Riser Block
690235	JTM-1050 Mill with ACU-RITE 200S DRO with X-Axis Powerfeed, Power Drawbar & 8" Riser Block
690214	JTM-1050 Mill with ACU-RITE 200S DRO with X & Y-Axis Powerfeeds
690258	JTM-1050 Mill with ACU-RITE 200S DRO with X, Y & Z-Axis Powerfeeds & Power Drawbar
690158	JTM-1050 Mill with 3-Axis ACU-RITE 200S DRO (Quill) & X-Axis Powerfeed
690159	JTM-1050 Mill with 3-Axis ACU-RITE 200S DRO (Quill) with X & Y-Axis Powerfeeds
690151	JTM-1050 Mill with 3-Axis ACU-RITE 200S DRO (Quill) with X & Y-Axis Powerfeeds & Power Drawbar
690160	JTM-1050 Mill with 3-Axis ACU-RITE 200S DRO (Quill) with X, Y & Z-Axis Powerfeeds
690164	JTM-1050 Mill with 3-Axis ACU-RITE 200S DRO (Knee) with X-Axis Powerfeed
690256	JTM-1050 Mill with 3-Axis ACU-RITE 200S DRO (Knee) with X & Y-Axis Powerfeeds
691403	JTM-1050 Mill with ACU-RITE VUE DRO with X-Axis Powerfeed & Air Power Drawbar
690450	JTM-1050 Mill with ACU-RITE VUE DRO with X, Y & Z-Axis Powerfeeds
690306	JTM-1050 Mill with ACU-RITE 300S DRO & X-Axis Powerfeed
690307	JTM-1050 Mill with ACU-RITE 300S DRO with X & Y-Axis Powerfeeds
691204	JTM-1050 Mill with Newall DP700 DRO
691172	JTM-1050 Mill with Newall DP700 DRO with Power Drawbar
691205	JTM-1050 Mill with Newall DP700 DRO with X-Axis Powerfeed
691206	JTM-1050 Mill with Newall DP700 DRO with X & Y-Axis Powerfeeds
692206	JTM-1050 MILL WITH NEWALL DP700 DRO, X & Z Powerfeeds
691207	JTM-1050 Mill with 3-Axis Newall DP700 DRO (Quill)
691208	JTM-1050 Mill with 3-Axis Newall DP700 DRO (Quill) with X-Axis Powerfeed
691209	JTM-1050 Mill with 3-Axis Newall DP700 DRO (Quill) with X & Y-Axis Powerfeeds
690234	JTM-1050 Mill with 3-Axis Newall DP700 DRO (Quill) with X, Y & Z-Axis Powerfeeds & Power Drawbar
691234	JTM-1050 Mill with 3-Axis Newall DP700 DRO (Knee)
691236	JTM-1050 Mill with Newall DP700 3-Axis (Knee) DRO & X-Axis Powerfeed

Call Customer Service at 888-804-7129 for additional packages or visit www.jettools.com to Custom Build your own Package.

JTM-1050EVS2 AND JTM-949 EVS VERTICAL MILLING MACHINES



690607

DURABILITY

- Meehanite® casting
- Hardened and ground table
- Chrome lead screws on X and Y axis
- Turcite B on X and Y axis
- Precision bored and honed milling head
- High precision Class 7 spindle bearings
- Satin chrome finished dials
- Large diameter quill is chromed
- Heavy-duty motor drive
- Chrome plated motor shaft with bearing support at end

SAFETY

- CSA/CUS: Following strict guidelines and electrical requirements, these JET Mills are CSA/CUS certified
- No fuse breaker power connection
- Heavy-duty spindle brake

EASE OF USE

- One-shot lubrication system
- Spindle head is internally cooled
- One-piece quill pinion and shaft

STANDARD EQUIPMENT

- One-shot lubrication system
- Way covers
- Draw bar
- Tool box with tools

OPTIONAL EQUIPMENT	STOCK NUMBER
External Coolant Pump Assembly	660125



STOCK NUMBER	690601	690501
Model Number	JTM-1050EVS2	JTM-949EVS
Table Size (in.)	10 x 50	9 x 49
Spindle Taper	R-8	R-8
Quill Diameter (in.)	3-3/8	3-3/8
Number of Spindle speeds	Variable	Variable
Range of Spindle Speeds (rpm)	60 - 4,500	60 - 4,500
Quill Down feed Rates (ipr)	.0015-.003-.006	.0015-.003-.006
Quill Travel (in.)	5	5
Head Movement (deg.)	90°R & L 45° F & B	90°R & L 45° F & B
Max Distance Spindle to Table (in.)	20-3/4	20-3/4
Distance Spindle to Column (max. / in.)	26-3/4	18-1/8
Distance Spindle to Column (min. / in.)	5.9	5.2
Collet Capacity (in.)	1/8 - 7/8	1/8 - 7/8
Table Longitudinal Travel (range / in.)	29-7/8 - 35-1/3	30-3/4 - 36
Table Cross Travel (in.)	14-3/4	12-5/8
T-Slots Number and Size (in.)	3 and 5/8	3 and 5/8
T-Slot Centers (in.)	2-1/2	2-1/2
Work Table Weight Capacity (lbs.)	840	660
Travel of Knee (in.)	16-1/8	15-3/4
Travel of Ram (in.)	17-3/8	8-1/8
Saddle Width (in.)	20	20
Column Width (in.)	11-1/2	11-1/2
Inverter Type	Delta, B	Delta, B
Motor (HP)	3HP, 230V, 3Ph	3HP, 230V, 3Ph
Net Weight (lbs.)	2486	2860

Call Customer Service at 888-804-7129 for additional packages or visit www.jettools.com to Custom Build your own Package.

JTM-1050EVS2 MILLING PACKAGES

STOCK NUMBER	DESCRIPTION
690601	JTM-1050EVS2/230 Mill with X-Axis Powerfeed
690602	JTM-1050EVS2/230 Mill with X-Axis Powerfeed & Air Power Drawbar
690603	JTM-1050EVS2/230 Mill with X & Y-Axis Powerfeeds
690604	JTM-1050EVS2/230 Mill with X, Y & Z-Axis Powerfeeds
690605	JTM-1050EVS2/230 Mill with Acu-Rite VUE DRO
690606	JTM-1050EVS2/230 Mill with Acu-Rite VUE DRO with X-Axis Powerfeed
690607	JTM-1050EVS2/230 Mill with Acu-Rite VUE DRO with X-Axis Powerfeed & Air Power Drawbar
690608	JTM-1050EVS2/230 Mill with Acu-Rite VUE DRO with X & Y-Axis Powerfeeds
690609	JTM-1050EVS2/230 Mill with Acu-Rite VUE DRO with X, Y & Z-Axis Powerfeeds
690610	JTM-1050EVS2/230 Mill with 3-Axis Acu-Rite VUE DRO (Knee) with X-Axis Powerfeed
690611	JTM-1050EVS2/230 Mill with 3-Axis Acu-Rite VUE DRO (Knee) with X-Axis Powerfeed & Air Power Draw
690612	JTM-1050EVS2/230 Mill with 3-Axis Acu-Rite VUE DRO (Knee) with X & Y-Axis Powerfeeds
690613	JTM-1050EVS2/230 Mill with 3-Axis Acu-Rite VUE DRO (Knee) with X, Y & Z-Axis Powerfeeds
690614	JTM-1050EVS2/230 Mill with 3-Axis Acu-Rite VUE DRO (Quill) with X-Axis Powerfeed
690615	JTM-1050EVS2/230 Mill with 3-Axis Acu-Rite VUE DRO (Quill) with X-Axis Powerfeed & Air Power Drawbar
690616	JTM-1050EVS2/230 Mill with 3-Axis Acu-Rite VUE DRO (Quill) with X & Y-Axis Powerfeeds
690617	JTM-1050EVS2/230 Mill with 3-Axis Acu-Rite VUE DRO (Quill) with X & Y-Axis Powerfeeds & Air Power Drawbar
690618	JTM-1050EVS2/230 Mill with 3-Axis Acu-Rite VUE DRO (Quill) with X, Y & Z-Axis Powerfeeds
690651	JTM-1050EVS2/230 Mill with 3-Axis Acu-Rite VUE DRO (Quill) with X, Y & Z-Axis Powerfeeds & Air Power Drawbar
690619	JTM-1050EVS2/230 Mill with Acu-Rite 200S DRO with X-Axis Powerfeed
690620	JTM-1050EVS2/230 Mill with Acu-Rite 200S DRO with X-Axis Powerfeed & Air Power Drawbar
690621	JTM-1050EVS2/230 Mill with Acu-Rite 200S DRO with X & Y-Axis Powerfeeds
690622	JTM-1050EVS2/230 Mill with Acu-Rite 200S DRO with X & Y-Axis Powerfeeds & Air Power Drawbar
690623	JTM-1050EVS2/230 Mill with Acu-Rite 200S DRO with X, Y & Z-Axis Powerfeeds
690650	JTM-1050EVS2/230 Mill with Acu-Rite 200S DRO with X, Y & Z-Axis Powerfeeds & Air Power Drawbar
690624	JTM-1050EVS2/230 Mill with 3-Axis Acu-Rite 200S DRO (Knee) with X-Axis Powerfeed
690625	JTM-1050EVS2/230 Mill with 3-Axis Acu-Rite 200S DRO (Knee) with X-Axis Powerfeed & Air Power Drawbar
690626	JTM-1050EVS2/230 Mill with 3-Axis Acu-Rite 200S DRO (Knee) with X & Y-Axis Powerfeeds

STOCK NUMBER	DESCRIPTION
690627	JTM-1050EVS2/230 Mill with 3-Axis Acu-Rite 200S DRO (Knee) with X & Y-Axis Powerfeeds & Air Power Drawbar
690628	JTM-1050EVS2/230 Mill with 3-Axis Acu-Rite 200S DRO (Knee) with X, Y & Z-Axis Powerfeeds
690629	JTM-1050EVS2/230 Mill with 3-Axis Acu-Rite 200S DRO (Quill) with X-Axis Powerfeed
690630	JTM-1050EVS2/230 Mill with 3-Axis Acu-Rite 200S DRO (Quill) with X-Axis Powerfeed & Air Power Drawbar
690631	JTM-1050EVS2/230 Mill with 3-Axis Acu-Rite 200S DRO (Quill) with X & Y-Axis Powerfeeds
690632	JTM-1050EVS2/230 Mill with 3-Axis Acu-Rite 200S DRO (Quill) with X & Y-Axis Powerfeeds & Air Power Drawbar
690633	JTM-1050EVS2/230 Mill with 3-Axis Acu-Rite 200S DRO (Quill) with X, Y & Z-Axis Powerfeeds
690680	JTM-1050EVS2/230 Mill with 3-Axis Acu-Rite 300S DRO (Knee) with X, Y & Z-Axis Powerfeeds & Air Power Drawbar
690634	JTM-1050EVS2/230 Mill with Newall DP700 DRO with X-Axis Powerfeed
690635	JTM-1050EVS2/230 Mill with Newall DP700 DRO with X-Axis Powerfeed & Air Power Drawbar
690636	JTM-1050EVS2/230 Mill with Newall DP700 DRO with X & Y-Axis Powerfeeds
690637	JTM-1050EVS2/230 Mill with Newall DP700 DRO with X & Y-Axis Powerfeeds & Air Power Drawbar
690638	JTM-1050EVS2/230 Mill with Newall DP700 DRO with X, Y & Z-Axis Powerfeeds
690639	JTM-1050EVS2/230 Mill with 3-Axis Newall DP700 DRO (Knee) with X-Axis Powerfeed
690640	JTM-1050EVS2/230 Mill with 3-Axis Newall DP700 DRO (Knee) with X-Axis Powerfeed & Air Power Draw
690641	JTM-1050EVS2/230 Mill with 3-Axis Newall DP700 DRO (Knee) with X & Y-Axis Powerfeeds
690642	JTM-1050EVS2/230 Mill with 3-Axis Newall DP700 DRO (Knee) with X & Y-Axis Powerfeeds & Air Power
690643	JTM-1050EVS2/230 Mill with 3-Axis Newall DP700 DRO (Knee) with X, Y & Z-Axis Powerfeeds
690644	JTM-1050EVS2/230 Mill with 3-Axis Newall DP700 DRO (Quill) with X-Axis Powerfeed
690645	JTM-1050EVS2/230 Mill with 3-Axis Newall DP700 DRO (Quill) with X-Axis Powerfeed & Air Power Drawbar
690646	JTM-1050EVS2/230 Mill with 3-Axis Newall DP700 DRO (Quill) with X & Y-Axis Powerfeeds
690647	JTM-1050EVS2/230 Mill with 3-Axis Newall DP700 DRO (Quill) with X & Y-Axis Powerfeeds & Air Power Drawbar
690648	JTM-1050EVS2/230 Mill with 3-Axis Newall DP700 DRO (Quill) with X, Y & Z-Axis Powerfeeds

Call Customer Service at 888-804-7129 for additional packages or visit www.jettools.com to Custom Build your own Package.

JTM-949 EVS MILLING PACKAGES

STOCK NUMBER	DESCRIPTION
690501	JTM-949EVS/230 Mill with X-Axis Powerfeed
690502	JTM-949EVS Mill with X-Axis Powerfeed & Air Power Drawbar
690503	JTM-949EVS Mill with X & Y-Axis Powerfeeds
690504	JTM-949EVS Mill with X, Y & Z-Axis Powerfeeds
690506	JTM-949EVS Mill with Acu-Rite VUE DRO with X-Axis Powerfeed
690507	JTM-949EVS Mill with Acu-Rite VUE DRO with X-Axis Powerfeed & Air Power Drawbar
690508	JTM-949EVS Mill with Acu-Rite VUE DRO with X & Y-Axis Powerfeeds
690509	JTM-949EVS Mill with Acu-Rite VUE DRO with X, Y & Z-Axis Powerfeeds
690510	JTM-949EVS Mill with 3-Axis Acu-Rite VUE DRO (Knee) with X-Axis Powerfeed
690511	JTM-949EVS Mill with 3-Axis Acu-Rite VUE DRO (Knee) with X-Axis Powerfeed & Air Power Drawbar
690512	JTM-949EVS Mill with 3-Axis Acu-Rite VUE DRO (Knee) with X & Y-Axis Powerfeeds
690513	JTM-949EVS Mill with 3-Axis Acu-Rite VUE DRO (Knee) with X & Y-Axis Powerfeeds & Air Power Drawbar
690514	JTM-949EVS Mill with 3-Axis Acu-Rite VUE DRO (Knee) with X, Y & Z-Axis Powerfeeds
690515	JTM-949EVS Mill with 3-Axis Acu-Rite VUE DRO (Quill) with X-Axis Powerfeed
690516	JTM-949EVS Mill with 3-Axis Acu-Rite VUE DRO (Quill) with X-Axis Powerfeed & Air Power Drawbar
690517	JTM-949EVS Mill with 3-Axis Acu-Rite VUE DRO (Quill) with X & Y-Axis Powerfeeds
690518	JTM-949EVS Mill with 3-Axis Acu-Rite VUE DRO (Quill) with X & Y-Axis Powerfeeds & Air Power Drawbar
690519	JTM-949EVS Mill with 3-Axis Acu-Rite VUE DRO (Quill) with X, Y & Z-Axis Powerfeeds
690520	JTM-949EVS Mill with Acu-Rite 200S DRO with X-Axis Powerfeed
690521	JTM-949EVS Mill with Acu-Rite 200S DRO with X-Axis Powerfeed & Air Power Drawbar
690522	JTM-949EVS Mill with Acu-Rite 200S DRO with X & Y-Axis Powerfeeds
690523	JTM-949EVS Mill with Acu-Rite 200S DRO with X & Y-Axis Powerfeeds & Air Power Drawbar
690524	JTM-949EVS Mill with Acu-Rite 200S DRO with X, Y & Z-Axis Powerfeeds
690525	JTM-949EVS Mill with 3-Axis Acu-Rite 200S DRO (Knee) with X-Axis Powerfeed
690526	JTM-949EVS Mill with 3-Axis Acu-Rite 200S DRO (Knee) with X-Axis Powerfeed & Air Power Drawbar

STOCK NUMBER	DESCRIPTION
690527	JTM-949EVS Mill with 3-Axis Acu-Rite 200S DRO (Knee) with X & Y-Axis Powerfeeds
690528	JTM-949EVS Mill with 3-Axis Acu-Rite 200S DRO (Knee) with X & Y-Axis Powerfeeds & Air Power Drawbar
690529	JTM-949EVS Mill with 3-Axis Acu-Rite 200S DRO (Knee) with X, Y & Z-Axis Powerfeeds
690530	JTM-949EVS Mill with 3-Axis Acu-Rite 200S DRO (Quill) with X-Axis Powerfeed
690531	JTM-949EVS Mill with 3-Axis Acu-Rite 200S DRO (Quill) with X-Axis Powerfeed & Air Power Drawbar
690532	JTM-949EVS Mill with 3-Axis Acu-Rite 200S DRO (Quill) with X & Y-Axis Powerfeeds
690533	JTM-949EVS Mill with 3-Axis Acu-Rite 200S DRO (Quill) with X & Y-Axis Powerfeeds & Air Power Drawbar
690534	JTM-949EVS Mill with 3-Axis Acu-Rite 200S DRO (Quill) with X, Y & Z-Axis Powerfeeds
690535	JTM-949EVS with Newall DP700 DRO & X Powerfeed
690536	JTM-949EVS with Newall DP700 DRO, X Powerfeed & Air Power Drawbar
690537	JTM-949EVS with Newall DP700 DRO, X & Y Powerfeeds
690538	JTM-949EVS with Newall DP700 DRO, X & Y Powerfeeds & Air Power Drawbar
690539	JTM-949EVS with Newall DP700 DRO X,Y & Z Powerfeeds
690540	JTM-949EVS Mill with 3-Axis Newall DP700 DRO (Knee) with X-Axis Powerfeed
690541	JTM-949EVS Mill with 3-Axis Newall DP700 DRO (Knee) with X-Axis Powerfeed & Air Power Drawbar
690542	JTM-949EVS DP700 3X (K) DRO X&Y Powerfeed
690543	JTM-949EVS Mill with 3-Axis Newall DP700 DRO (Knee) with X & Y-Axis Powerfeeds & Air Power Drawbar
690544	JTM-949EVS Mill with 3-Axis Newall DP700 DRO (Knee) with X, Y & Z-Axis Powerfeeds
690545	JTM-949EVS Mill with 3-Axis Newall DP700 DRO (Quill) with X-Axis Powerfeed
690546	JTM-949EVS Mill with 3-Axis Newall DP700 DRO (Quill) with X-Axis Powerfeed & Air Power Drawbar
690547	JTM-949EVS Mill with 3-Axis Newall DP700 DRO (Quill) with X & Y-Axis Powerfeeds
690548	JTM-949EVS Mill with 3-Axis Newall DP700 DRO (Quill) with X & Y-Axis Powerfeeds & Air Power Drawbar
690549	JTM-949EVS Mill with 3-Axis Newall DP700 DRO (Quill) with X, Y & Z-Axis Powerfeeds

Call Customer Service at 888-804-7129 for additional packages or visit www.jettools.com to Custom Build your own Package.

JTM-4VS VARIABLE SPEED VERTICAL MILLING MACHINE



DURABILITY

- Certified Meehanite® castings
- Precision bored and honed milling head
- Large diameter quill is chromed
- High precision Class 7 spindle bearings
- Chrome plated motor shaft with lower bearing support
- One piece quill pinion and shaft
- Spindle head is internally cooled
- Heavy-duty splined motor drive
- Precision hardened and ground ways and table

SAFETY

- Heavy-duty spindle brake
- Locks on all movable surfaces

EASE OF USE

- Three stage power downfeed with automatic stop
- Internal coolant tank built into casting base for use with coolant system (coolant pump not included)
- One shot lubrication system



STOCK NUMBER	690180	690182
Model Number	JTM-4VS-1	JTM-4VS
Table Size (in.)	9 x 49	9 x 49
Spindle Taper	R-8	R-8
Quill Diameter (in.)	3-3/8	3-3/8
Number of Spindle Speeds	Variable	Variable
Range of Spindle Speeds (rpm)	60 - 4,200	60 - 4,200
Quill Down Feed Rates (per./rev./in.)	.0015 - .003 - .006	.0015 - .003 - .006
Spindle Travel (in.)	5	5
Head Movement (deg.)	90° R & L, 45° F & B	90° R & L, 45° F & B
Max Distance Spindle to Table (in.)	17-1/2	17-1/2
Distance Spindle to Column (max. / in.)	19	19
Distance Spindle to Column (min. / in.)	4-1/2	4-1/2
Collet Capacity	1/8 - 7/8	1/8 - 7/8
Table Longitudinal Travel (in.)	34	34
Table Cross Travel (in.)	12	12
T-Slots Number and Size (in.)	3 and 5/8	3 and 5/8
T-Slot Centers (in.)	2-1/2	2-1/2
Work Table Weight Capacity (lbs.)	660	660
Travel of Knee (in.)	14-1/2	14-1/2
Travel of Ram (in.)	13-3/8	13-3/8
Motor (HP)	2HP, 115/230V, 1Ph, Prewired 230V	3HP, 230/460V, 3Ph, Prewired 230V
Overall Dimensions (L x W x H / in.)	66 x 63 x 85	66 x 63 x 85
Net Weight (lbs.)	2,420	2,420

Call Customer Service at 888-804-7129 for additional packages or visit www.jetttools.com to Custom Build your own Package.

JTM-4VS

MILLING PACKAGES

STOCK NUMBER	DESCRIPTION
690183	JTM-4VS Mill with X-Axis Powerfeed
690008	JTM-4VS Mill with X & Y-Axis Powerfeeds
690009	JTM-4VS Mill with X & Y-Axis Powerfeeds with Power Drawbar
690013	JTM-4VS Mill with X, Y & Z-Axis Powerfeeds
690119	JTM-4VS Mill with Air Power Drawbar
691088	JTM-4VS Mill with ACU-RITE VUE DRO
690401	JTM-4VS Mill with ACU-RITE VUE DRO with X-Axis Powerfeed
690265	JTM-4VS Mill with ACU-RITE VUE DRO with X-Axis Powerfeed & 6" Riser Block
690415	JTM-4VS Mill with ACU-RITE VUE DRO with X-Axis Powerfeed & Power Drawbar
690420	JTM-4VS Mill with ACU-RITE VUE DRO with X & Y-Axis Powerfeeds
690417	JTM-4VS Mill with ACU-RITE VUE DRO with X, Y & Z-Axis Powerfeeds
690015	JTM-4VS Mill with ACU-RITE VUE DRO with X & Z-Axis Powerfeeds
690416	JTM-4VS Mill with 3-Axis ACU-RITE VUE DRO (Quill) with X & Y-Axis Powerfeeds
690408	JTM-4VS Mill with 3-Axis ACU-RITE VUE DRO (Knee) with X-Axis Powerfeed
690412	JTM-4VS Mill with 3-Axis ACU-RITE VUE DRO (Knee) with X & Y-Axis Powerfeeds
690418	JTM-4VS Mill with 3-Axis ACU-RITE VUE DRO (Knee) with X, Y & Z-Axis Powerfeeds
690202	JTM-4VS Mill with ACU-RITE 200S DRO
690107	JTM-4VS Mill with ACU-RITE 200S DRO with X-Axis Powerfeed
690125	JTM-4VS Mill with ACU-RITE 200S DRO with X-Axis Powerfeed & Power Drawbar
690098	JTM-4VS Mill with ACU-RITE 200S DRO with X & Y-Axis Powerfeeds
690230	JTM-4VS Mill with ACU-RITE 200S DRO with X & Y-Axis Powerfeeds & Power Drawbar
690099	JTM-4VS Mill with ACU-RITE 200S DRO with X, Y & Z-Axis Powerfeeds
690231	JTM-4VS Mill with Acu-Rite 200S DRO with X, Y & Z-Axis Powerfeeds with Air Power Drawbar
690184	JTM-4VS Mill with 3-Axis ACU-RITE 200S DRO (Quill)
690221	JTM-4VS Mill with 3-Axis ACU-RITE 200S DRO (Quill) & X-Axis Powerfeeds

STOCK NUMBER	DESCRIPTION
690251	JTM-4VS Mill with 3-Axis ACU-RITE 200S DRO (Quill) with X-Axis Powerfeed & Power Drawbar
690140	JTM-4VS Mill with 3-Axis ACU-RITE 200S DRO (Quill) with X & Y-Axis Powerfeeds
690139	JTM-4VS Mill with 3-Axis ACU-RITE 200S DRO (Quill) with X & Y-Axis Powerfeeds & Power Drawbar
690141	JTM-4VS Mill with 3-Axis ACU-RITE 200S DRO (Quill) with X, Y & Z-Axis Powerfeeds
690153	JTM-4VS Mill with 3-Axis ACU-RITE 200S DRO (Quill), with X, Y & Z-Axis Powerfeeds with Power Drawbar
690400	JTM-4VS Mill with 3-Axis ACU-RITE 200S (Knee) & Power Drawbar
690430	JTM-4VS Mill with 3-Axis ACU-RITE 300S DRO (Knee) with X, Y & Z-Axis Powerfeeds & Power Drawbar
690301	JTM-4VS Mill with 300S DRO & X-Axis Powerfeed
690302	JTM-4VS Mill with 300S DRO with X & Y-Axis Powerfeeds
691200	JTM-4VS Mill with Newall DP700 DRO
690087	JTM-4VS Mill with Newall DP700 DRO & X-Axis Powerfeed
690069	JTM-4VS Mill with Newall DP700 DRO with X-Axis Powerfeed & Power Drawbar
691201	JTM-4VS Mill with Newall DP700 DRO with X & Y-Axis Powerfeeds
690115	JTM-4VS Mill with Newall DP700 DRO with X & Y-Axis Powerfeeds & Air Power Drawbar
691202	JTM-4VS Mill with 3-Axis Newall DP700 DRO (Quill)
690090	JTM-4VS Mill with 3-Axis Newall DP700 DRO (Quill) with X-Axis Powerfeed
691203	JTM-4VS Mill with 3-Axis Newall DP700 DRO (Quill) with X & Y-Axis Powerfeeds
691170	JTM-4VS Mill with 3-Axis Newall DP700 DRO (Quill) with X, Y & Z-Axis Powerfeeds & Power Drawbar
691232	JTM-4VS Mill with 3-Axis Newall DP700 DRO (Knee) with X-Axis Powerfeed
690093	JTM-4VS Mill with 3-Axis Newall DP700 DRO (Knee) with X, Y & Z-Axis Powerfeeds
690094	JTM-4VS Mill with 3-Axis Newall DP700 DRO (Knee) with X, Y & Z-Axis Powerfeeds & Power Drawbar

Call Customer Service at 888-804-7129 for additional packages or visit www.jettools.com to Custom Build your own Package.

JTM-4VS-1 MILLING PACKAGES

STOCK NUMBER	DESCRIPTION
690178	JTM-4VS-1 Mill with X-Axis Powerfeed
690197	JTM-4VS-1 Mill with X & Y-Axis Powerfeeds
692402	JTM-4VS-1 with ACU-RITE VUE DRO
690402	JTM-4VS-1 Mill with ACU-RITE VUE DRO with X-Axis Powerfeed
690407	JTM-4VS-1 Mill with ACU-RITE VUE DRO & X & Y-Axis Powerfeeds
690422	JTM-4VS-1 Mill with ACU-RITE VUE DRO with X & Y-Axis Powerfeeds & Power Drawbar
690410	JTM-4VS-1 Mill with 3-Axis ACU-RITE VUE DRO (Quill) with X-Axis Powerfeed
690413	JTM-4VS-1 Mill with 3-Axis ACU-RITE VUE DRO (Quill) with X & Y-Axis Powerfeeds
690421	JTM-4VS-1 Mill with 3-Axis ACU-RITE VUE DRO (Quill) with X, Y & Z-Axis Powerfeeds
690411	JTM-4VS-1 Mill with 3-Axis ACU-RITE VUE DRO (Knee) with X-Axis Powerfeeds
690424	JTM-4VS-1 Mill with 3-Axis ACU-RITE VUE DRO (Knee) with X, Y & Z-Axis Powerfeeds
690179	JTM-4VS-1 Mill with ACU-RITE 200S DRO with X-Axis Powerfeed
690068	JTM-4VS-1 Mill with 3-Axis ACU-RITE 200S DRO (Quill) with X & Y-Axis Powerfeeds
690303	JTM-4VS-1 Mill with ACU-RITE 300S DRO with X-Axis Powerfeed
691411	JTM-4VS-1 Mill with 3-Axis ACU-RITE 200S DRO (Knee) with X-Axis Powerfeed
690118	JTM-4VS-1 Mill with 3-Axis ACU-RITE 300S DRO (Quill) with X & Y-Axis Powerfeeds
692087	JTM-4VS-1 with Newall DP700 DRO
691087	JTM-4VS-1 Mill with Newall DP700 DRO with X-Axis Powerfeed
692306	JTM-4VS-1 Mill with Newall DP700 DRO with X & Y-Axis Powerfeeds & 6" Riser Block
691171	JTM-4VS-1 Mill with 3-Axis Newall DP700 DRO (Quill) with X, Y & Z-Axis Powerfeeds & Power Drawbar

Call Customer Service at 888-804-7129 for additional packages or visit www.jettools.com to Custom Build your own Package.



690430

JTM-1/2 STEP PULLEY MILLING MACHINES



690082

DURABILITY

- Certified Meehanite® castings
- Precision bored and honed milling head
- Large diameter quill is chromed
- High precision Class 7 spindle bearings
- Chrome plated motor shaft with lower bearing support
- One piece quill pinion and shaft
- Spindle head is internally cooled
- Heavy-duty splined motor drive
- Precision hardened and ground ways and table

SAFETY

- Heavy-duty spindle brake
- Locks on all movable surfaces

EASE OF USE

- Three stage power downfeed with automatic stop
- Adjustable gibs throughout
- Internal coolant tank built into casting base for use with coolant system (coolant pump not included)
- One shot lubrication system

STOCK NUMBER	690082	690089
Model Number	JTM-1	JTM-2
Table Size (in.)	9 x 42	9 x 42
Spindle Taper	R-8	R-8
Quill Diameter (in.)	3-3/8	3-3/8
Number of Spindle Speeds	16	8
Range of Spindle Speeds (rpm)	80 - 5,440	80 - 2,720
Quill Down Feed Rates (ipr)	.0015 - .003 - .006	.0015 - .003 - .006
Spindle Travel (in.)	5	5
Head Movement (deg.)	90° R & L, 45° F & B	90° R & L, 45° F & B
Max Distance Spindle to Table (in.)	17-1/2	17-1/2
Distance Spindle to Column (max. / in.)	19	19
Distance Spindle to Column (min. / in.)	4-1/2	4-1/2
Collet Capacity	1/8 - 7/8	1/8 - 7/8
Table Longitudinal Travel (in.)	23-7/8	23-7/8
Table Cross Travel (in.)	12-1/2	12-1/2
T-Slots Number and Size (in.)	3 and 5/8	3 and 5/8
T-Slot Centers (in.)	2-1/2	2-1/2
Work Table Weight Capacity (lbs.)	550	550
Travel of Knee (in.)	14-1/2	14-1/2
Travel of Ram (in.)	13-3/8	13-3/8
Motor (HP)	2HP, 230V, 3Ph	2HP, 115/230V, 1Ph, Prewired 230V
Overall Dimensions (L x W x H / in.)	57 x 64 x 82	57 x 64 x 82
Net Weight (lbs.)	2056	2056



JTM-1 MILLS AND ACCESSORY PACKAGES	
690019	JTM-1 Mill with X-Axis Powerfeed
690097	JTM-1 Mill with X and Y-Axis Powerfeeds
690280	JTM-1 Mill with ACU-RITE VUE DRO
690281	JTM-1 Mill with ACU-RITE VUE DRO with X-Axis Powerfeed
690282	JTM-1 Mill with ACU-RITE VUE DRO with X and Y-Axis Powerfeeds
690244	JTM-1 Mill with ACU-RITE 200S DRO
690168	JTM-1 Mill with ACU-RITE 200S DRO and X-Axis Powerfeed
690161	JTM-1 Mill with ACU-RITE 200S DRO with X and Y-Axis Powerfeeds
692182	JTM-1 Mill with 3-Axis Newall DP500 DRO (Knee)
692187	JTM-1 Mill with Newall DP500 DRO
692188	JTM-1 Mill with Newall DP500 DRO with X-Axis Powerfeeds
692189	JTM-1 Mill with Newall DP500 DRO with X & Y-Axis Powerfeeds
692190	JTM-1 Mill with 3-Axis Newall DP500 DRO (Quill)
692191	JTM-1 Mill with 3-Axis Newall DP500 DRO (Quill) with X-Axis Powerfeeds
692192	JTM-1 Mill with 3-Axis Newall DP500 DRO (Quill) with X & Y-Axis Powerfeeds
692196	JTM-1 Mill with 3-Axis Newall DP500 DRO (Knee)
691187	JTM-1 Mill with Newall DP700 DRO
691188	JTM-1 Mill with Newall DP700 DRO with X-Axis Powerfeed
691189	JTM-1 Mill with Newall DP700 DRO with X and Y-Axis Powerfeeds
691190	JTM-1 Mill with 3-Axis Newall DP700 DRO (Quill)
691191	JTM-1 Mill with 3-Axis Newall DP700 DRO (Quill) with X-Axis Powerfeed
691192	JTM-1 Mill with 3-Axis Newall DP700 DRO (Quill) with X and Y-Axis Powerfeeds
691196	JTM-1 Mill with 3-Axis Newall DP700 DRO (Knee)

Call Customer Service at 888-804-7129 for additional packages or visit www.jettools.com to Custom Build your own Package.

JTM-2 MILLS AND ACCESSORY PACKAGES	
690089	JTM-2 Step Pulley Milling Machine 115/230V 1Ph
690006	JTM-2 Mill with X-Axis Powerfeed
690017	JTM-2 Mill with X and Y-Axis Powerfeeds
690283	JTM-2 Mill with ACU-RITE VUE DRO
690286	JTM-2 Mill with ACU-RITE VUE DRO with X-Axis Powerfeed
690285	JTM-2 Mill with ACU-RITE VUE DRO with X and Y-Axis Powerfeeds
690114	JTM-2 Mill with ACU-RITE 200S DRO and X-Axis Powerfeed
690210	JTM-2 Mill with ACU-RITE 200S DRO and X and Y-Axis Powerfeeds
690072	JTM-2 Mill with 3-Axis ACU-RITE 200S DRO (Quill) with X-Axis Powerfeed
690157	JTM-2 Mill with 3-Axis ACU-RITE 200S DRO (Quill) with X and Y-Axis Powerfeeds
690095	JTM-2 W 3X 200S (KNEE), X-PWRFD
692193	JTM-2 Mill with Newall DP500 DRO
692194	JTM-2 Mill with Newall DP500 DRO with X-Axis Powerfeeds
692195	JTM-2 Mill with Newall DP500 DRO with X & Y-Axis Powerfeeds
692197	JTM-2 Mill with 3-Axis Newall DP500 DRO (Quill)
692198	JTM-2 Mill with 3-Axis Newall DP500 DRO (Quill) with X-Axis Powerfeeds
692199	JTM-2 Mill with 3-Axis Newall DP500 DRO (Quill) with X & Y-Axis Powerfeeds
691193	JTM-2 Mill with Newall DP700 DRO
691194	JTM-2 Mill with Newall DP700 DRO with X-Axis Powerfeed
691195	JTM-2 Mill with Newall DP700 DRO with X and Y-Axis Powerfeeds
691197	JTM-2 Mill with 3-Axis Newall DP700 DRO (Quill)
691198	JTM-2 Mill with 3-Axis Newall DP700 DRO(Quill) with X-Axis Powerfeed
691199	JTM-2 Mill with 3-Axis Newall DP700 DRO (Quill) with X and Y-Axis Powerfeeds
691182	JTM-2 Mill with 3-Axis Newall DP700 DRO (Knee)

JVM-836-1/3 STEP PULLEY MILLING MACHINES



690036

DURABILITY

- Precision bored and honed milling head
- High precision spindle bearings
- Large diameter quill is chromed
- Hardened and ground precision table

SAFETY

- Locks on all movable surfaces

EASE OF USE

- Over 10" of front to back ram travel
- Head tilts left or right
- One-shot lubrication system



STOCK NUMBER	690036	690038
Model Number	JVM-836-1	JVM-836-3
Table Size (in.)	7-7/8 x 35-3/4	7-7/8 x 35-3/4
Spindle Taper	R-8	R-8
Quill Diameter (in.)	3-3/8	3-3/8
Number of Spindle Speeds	5	10
Range of Spindle Speeds (rpm)	240 - 1,550	120 - 1,550
Spindle Travel (in.)	5	5
Head Movement (deg.)	90° R & L	90° R & L
Max Distance Spindle to Table (in.)	13-3/4	13-3/4
Distance Spindle to Column (max. / in.)	15-3/4	15-3/4
Distance Spindle to Column (min. / in.)	5-1/4	5-1/4
Collet Capacity	1/8 - 7/8	1/8 - 7/8
Table Longitudinal Travel (in.)	22-1/4	22-1/4
Table Cross Travel (in.)	9-1/2	9-1/2
T-Slots Number and Size (in.)	3 and 5/8	3 and 5/8
T-Slot Centers (in.)	2-1/2	2-1/2
Work Table Weight Capacity (lbs.)	500	500
Travel of Knee (in.)	14	14
Travel of Ram (in.)	10-1/2	10-1/2
Motor (HP)	1-1/2HP, 115/230V, 1Ph, Prewired115V	1-1/2HP, 230V Only, 3Ph
Overall Dimensions (L x W x H / in.)	55 x 52 x 78	55 x 52 x 78
Net Weight (lbs.)	1,617	1,610

JVM-836-1 MILL ACCESSORY PACKAGES	
690156	JVM-836-1 Mill with X-Axis Powerfeed
690211	JVM-836-1 TPFA-2X & TPFA-2Y
690239	JVM-836-1 Mill with ACU-RITE VUE DRO
690198	JVM-836-1 Mill with ACU-RITE VUE DRO and X-Axis Powerfeed
690212	JVM-836-1 Mill with ACU-RITE VUE DRO with X and Y-Axis Powerfeeds
690213	JVM-836-1 Mill with 3-Axis ACU-RITE VUE DRO (Quill) with X-Axis Powerfeeds
691177	JVM-836-1 Mill with 3-Axis Newall DP700 DRO (Quill) and X-Axis Powerfeed
690144	JVM-836-1 Mill with ACU-RITE 200S DRO with X-Axis Powerfeed
690162	JVM-836-1W/AC 2-AX TPFA-2X&TPFA-2Y
691173	JVM-836-1 Mill with Newall DP700 DRO
691174	JVM-836-1 Mill with Newall DP700 DRO with X-Axis Powerfeed
691175	JVM-836-1 Mill with Newall DP700 DRO with X and Y-Axis Powerfeed
691176	JVM-836-1 Mill with 3-Axis Newall DP700 DRO (Quill)
690177	JVM-836-1 Mill with ACU-RITE 200S DRO
691178	JVM-836-1 MILL W/DP700 3AX Q-DRO&X&Y-PWF
691228	JVM-836-1 Mill with 3-Axis Newall DP700 DRO (Knee)
690038	JVM-836-3 Step Pulley Milling Machine 230V 3Ph
690174	JVM-836-3 Mill with X-Axis Powerfeed
690175	JVM-836-3 Mill with X and Y-Axis Powerfeeds
690191	JVM-836-3 Mill with ACU-RITE VUE DRO
690194	JVM-836-3 Mill with ACU-RITE VUE DRO with X-Axis Powerfeed
690190	JVM-836-3 Mill with ACU-RITE 200S DRO
690146	JVM-836-3 W/AC 200S 2-AX TPFA-X
690047	JVM-836-3 Mill with 3-Axis ACU-RITE 200S DRO (Knee) with X and Y-Axis Powerfeeds
691179	JVM-836-3 Mill with Newall DP700-DRO
691180	JVM-836-3 Mill with DP700-DRO with X-Axis Powerfeed
691183	JVM-836-3 Mill with Newall DP700 DRO with X and Y-Axis Powerfeeds
691184	JVM-836-3 Mill with 3-Axis Newall DP700 DRO (Quill)
691185	JVM-836-3 Mill with 3-Axis Newall DP700 DRO (Quill) with X-Axis Powerfeed
691186	JVM-836-3 Mill with 3-Axis Newall DP700 DRO (Quill) with X and Y-Axis Powerfeeds

Call Customer Service at 888-804-7129 for additional packages or visit www.jettools.com to Custom Build your own Package.

JMD MILL DRILL MACHINES



350018

DURABILITY

- One-piece cast iron column for added support

SAFETY

- UL Listed motor
- New positive quick-stop knob and easy-to-read internal depth gauge (external on JMD-15)
- Worklamp
- Drill chuck guard

EASE OF USE

- Forward and reverse switch on JMD-18
- Belt cover – quick slide latch allows faster belt adjustment to change spindle speeds

STANDARD EQUIPMENT

- Adjustable carbide facemill
- Drill press angle vise
- 1/2" drill chuck, chuck arbor
- Draw bar



350045



OPTIONAL EQUIPMENT	STOCK NUMBER
Stand with Enclosed Shelf	350045
Powerfeed (JMD-18, 18PF Only)	350083
Clamping Kit for JMD-18 & JMD-18PFN	660038

STOCK NUMBER	350017	350018	350020
Model Number	JMD-15	JMD-18	JMD-18PFN
Drilling Capacity (in.)	1	1-1/4	1-1/4
Face Mill Capacity (in.)	2-1/2	3	3
End Mill Capacity (in.)	1/2	3/4	3/4
Swing (in.)	14-1/2	15-7/8	15-7/8
Max Distance Spindle to Table (in.)	15	18	26
Spindle Taper	R-8	R-8	R-8
Spindle Travel Manual (in.)	3-1/2	5	5
Spindle Travel Auto (in.)	-	-	4-1/4
Quill Diameter (in.)	2-7/16	3	3
Column Diameter (in.)	3-5/8	4-1/2	4-1/2
Range of Power Downfeeds		-	0.0047", 0.007", 0.01"
Number of Spindle Speeds	12	12	12
Range of Spindle Speeds (rpm)	110 - 2,580	150 - 3,000	150 - 3,000
Max. Table Travel (in.)	14	20-1/2	20-1/2
Cross Travel (in.)	5-1/2	6-1/2	6-1/2
Working Surface of Table (in.)	7-1/2 x 23	9-1/2 x 32-1/4	9-1/2 x 32-1/4
T-Slots, Number and Size (in.)	4 and 9/16	4 and 5/8	4 and 5/8
T-Slot Centers (in.)	1-13/16	1-13/16	1-13/16
Base Dimensions (in.)	12-1/2 x 19-3/4	15-3/4 x 23-3/4	15-3/4 x 23-3/4
Motor (UL Listed)	1HP, 1Ph, 115/230V	2HP, 115/230V	2HP, 1Ph, 230V Only
Prewired	115V	115V	-
Overall Dimensions (L x W x H / in.)	38 x 37-1/2 x 42	47 x 40 x 51	47 x 40 x 51
Net Weight (lbs.)	440	660	700

JMD-15 PACKAGES

350116	JMD-15 Mill/Drill with ACU-RITE VUE DRO
350132	JMD-15 Mill/Drill with NEWALL DP500 DRO
350125	JMD-15 Mill/Drill with NEWALL DP700 DRO

JMD-18 PACKAGES

350119	JMD-18 Mill/Drill with X-Axis Table Powerfeed
350401	JMD-18 Mill/Drill with ACU-RITE VUE DRO
350133	JMD-18 Mill/Drill with NEWALL DP500 DRO
350134	JMD-18 Mill/Drill with Newall DP500 DRO and X-Axis Table Powerfeed
350126	JMD-18 Mill/Drill with NEWALL DP700 DRO
350127	JMD-18 Mill/Drill with Newall DP700 DRO and X-Axis Table Powerfeed

JMD-18PFN MILLING AND DRILLING MACHINES, BENCH TOP

350020	JMD-18PFN Mill/Drill with Power Downfeed 115/230V 1Ph
--------	---

JMD-18PFN PACKAGES

350402	JMD-18PFN Mill/Drill with ACU-RITE VUE DRO
350120	JMD-18PFN Mill/Drill with ACU-RITE VUE DRO and X-Axis Table Powerfeed
350135	JMD-18PFN Mill/Drill with NEWALL DP500 DRO
350136	JMD-18PFN Mill/Drill with NEWALL DP500 DRO and X-Axis Table Powerfeed
350128	JMD-18PFN Mill/Drill with NEWALL DP700 DRO
350129	JMD-18PFN Mill/Drill with NEWALL DP700 DRO and X-Axis Table Powerfeed

Call Customer Service at 888-804-7129 for additional packages or visit www.jettools.com to Custom Build your own Package.

NEW

GEARED HEAD MILL DRILL



DURABILITY

- Heavy-duty design allows for a variety of precision drilling applications
- Full power to the cutting tools through 6 speed geared head

SAFETY

- CSA/US: Following strict guidelines and electrical requirements, this JET Mill Drill is CSA/US certified
- Spindle guard
- Work lamp

EASE OF USE

- Calibrated fine down feed built in
- Easy-to-read internal depth gauge
- Head tilts left & right 90°
- Rapid spindle speed changes through quick-select gear shift levers
- Forward/reverse switch
- Milling table allows for movement
- R8 Spindle allows use of standard mill tooling
- Power Downfeed standard on 351041

OPTIONAL EQUIPMENT	STOCK NUMBER
Stand with Enclosed Shelf	350045
X-Powerfeed	350083

351040

**SHOWN WITH
OPTIONAL STAND**



STOCK NUMBER	351040	351041
Model Number	JMD-40GH	JMD-40GHPFN
Drilling Capacity (in.)	1-1/2	1-1/2
Face Mill Capacity (in.)	4	4
End Mill Capacity (in.)	3/4	3/4
Swing (in.)	21	21
Max Distance Spindle to Table (in.)	15-3/4	15-3/4
Spindle Taper	R8	R8
Spindle Travel Manual (in.)	5	5
Spindle Auto Travel (in.)		4-1/4
Quill Diameter (in.)	3	3
Column Diameter (in.)	4-1/2	4-1/2
Number of Spindle Speeds	6	6
Range of Spindle Speeds (rpm)	65-1550	65-1550
Max. Table Travel (in.)	20-1/2	20-1/2
Cross Travel (in.)	8-1/4	8-1/4
Working Surface of Table (in.)	8-1/4 x 28-3/4	8-1/4 x 28-3/4
T-slots, Number and Size (in.)	4 & 5/8	4 & 5/8
Base Dimensions (in.)	24-1/4 x 15-15/16	24-1/4 x 15-15/16
Motor (HP)	1-1/2HP, 115/230V, 1Ph	1-1/2HP, 115/230V, 1Ph
Prewired	115V, 4P	115V, 4P
Overall Dimensions (L x W x H / in.)	28 x 39-1/4 x 42-1/2	28 x 39-1/4 x 42-1/2
Net Weight (lbs.)	628	628
Gross Weight (lbs.)	694	694

JMD-40 PACKAGES	
351140	JMD-40GH Geared Head Mill Drill with NEWALL DP700 2-AXIS DRO
351141	JMD-40GH Geared Head Mill Drill with NEWALL DP700 2-AXIS DRO & X-Powerfeed
351142	JMD-40GHPF Geared Head Mill Drill with Power Downfeed & NEWALL DP700 2-AXIS DRO
351143	JMD-40GHPF Geared Head Mill Drill with Power Downfeed & NEWALL DP700 2-AXIS DRO & X-Powerfeed
351144	JMD-40GH Geared Head Mill Drill with NEWALL DP500 2-AXIS DRO
351145	JMD-40GH Geared Head Mill Drill with NEWALL DP500 2-AXIS DRO & X-Powerfeed
351146	JMD-40GHPF Geared Head Mill Drill with Power Downfeed & NEWALL DP500 2-AXIS DRO
351147	JMD-40GHPF Geared Head Mill Drill with Power Downfeed & NEWALL DP500 2-AXIS DRO & X-Powerfeed

Call Customer Service at 888-804-7129 for additional packages or visit www.jettools.com to Custom Build your own Package.

NEW

SQUARE COLUMN GEARED HEAD MILL DRILLS

DURABILITY

- Heavy-duty design allows for a variety of precision drilling applications
- Full power to the cutting tools through 6 speed geared head
- Square column with dovetail ways

SAFETY

- CSA/US: Following strict guidelines and electrical requirements, this JET Mill Drill is CSA/US certified
- Spindle guard
- Work lamp

EASE OF USE

- Calibrated fine down feed built in
- Easy-to-read internal depth gauge
- Head tilts left & right 90°
- Rapid spindle speed changes through quick-select gear shift levers
- Forward/reverse switch
- Milling table allows for movement
- R8 Spindle allows use of all standard mill tooling
- Power Downfeed standard on 351046, 35150 and 351051
- Tapping comes standard on 351051



351051



350045



OPTIONAL EQUIPMENT	STOCK NUMBER
Stand with Enclosed Shelf	350045
X-Powerfeed	350083

STOCK NUMBER	351045	351046	351050	351051
Model Number	JMD-45GH	JMD-45GHPFN	JMD-45VSPF	JMD-45VSPFT
Drilling Capacity (in.)	1-1/2	1-1/2	1-1/2	1-1/2
Face Mill Capacity (in.)	4	4	4	4
End Mill Capacity (in.)	3/4	3/4	3/4	3/4
Tapping Capacity (in.)				3/4
Swing (in.)	19-11/16	19-11/16	19-11/16	19-11/16
Max Distance Spindle to Table (in.)	18-1/8	18-1/8	18-1/8	18-1/8
Spindle Taper	R8	R8	R8	R8
Spindle Travel Manual (in.)	5	5	5	5
Spindle Auto Travel (in.)		4-1/4	4-1/4	4-1/4
Quill Diameter (in.)	3	3	3	3
Column Diameter (in.)	7-7/8 x 7-5/8 Square	7-7/8 x 7-5/8 Square	7-7/8 x 7-5/8 Square	7-7/8 x 7-5/8 Square
Number of Spindle Speeds	6	6	Variable Speed	Variable Speed
Range of Spindle Speeds (rpm)	65-1550	65-1550	50-2500	50-2500
Max. Table Travel (in.)	20-1/2	20-1/2	20-1/2	20-1/2
Cross Travel (in.)	8-1/4	8-1/4	8-1/4	8-1/4
Working Surface of Table (in.)	9-1/2 x 32-1/4	9-1/2 x 32-1/4	9-1/2 x 32-1/4	9-1/2 x 32-1/4
T-slots, Number and Size (in.)	4 & 5/8	4 & 5/8		
Base Dimensions (in.)	26-11/16 x 15-15/16	26-11/16 x 15-15/16	26-11/16 x 15-15/16	26-11/16 x 15-15/16
Motor (HP)	1-1/2HP, 115/230V, 1Ph	1-1/2HP, 115/230V, 1Ph	1-1/2HP, 115/230V, 1Ph	1-1/2HP, 115/230V, 1Ph
Prewired	115V, 4P	115V, 4P	115V, 4P	115V, 4P
Overall Dimensions (L x W x H / in.)	29 x 36 x 50	29 x 36 x 50	29 x 36 x 50	29 x 36 x 50
Gross Weight (lbs.)	754	754	767	767
Net Weight (lbs.)	800	800	820	820

Call Customer Service at 888-804-7129 for additional packages or visit www.jettools.com to Custom Build your own Package.

JMD-45 PACKAGES	
351150	JMD-45GH Geared Head Square Column Mill Drill with NEWALL DP700 2-AXIS DRO
351151	JMD-45GH Geared Head Square Column Mill Drill with NEWALL DP700 2-AXIS DRO & X-Powerfeed
351152	JMD-45GHPF Geared Head Square Column Mill Drill with Power Downfeed with NEWALL DP700 2-AXIS DRO
351153	JMD-45GHPF Geared Head Square Column Mill Drill with Power Downfeed with NEWALL DP700 2-AXIS DRO & X-Axis Powerfeed
351154	JMD-45VSPF Variable Speed Square Column Geared Head Mill Drill with NEWALL DP700 2-AXIS DRO
351155	JMD-45VSPF Variable Speed Square Column Geared Head Mill Drill with NEWALL DP700 2-AXIS DRO & X-Axis Powerfeed
351156	JMD-45VSPFT Variable Speed Geared Head Square Column Mill Drill with Power Downfeed & NEWALL DP500 2-AXIS DRO
351157	JMD-45VSPFT Variable Speed Geared Head Square Column Mill Drill with Power Downfeed & NEWALL DP500 2-AXIS DRO & X-Axis Powerfeed

JMD-45 PACKAGES	
351158	JMD-45GH Geared Head Square Column Mill Drill With NEWALL DP500 2-AXIS DRO
351159	JMD-45GH Geared Head Square Column Mill Drill with NEWALL DP500 2-AXIS DRO & X-Powerfeed
351160	JMD-45GHPF Geared Head Square Column Mill Drill with Power Downfeed with NEWALL DP500 2-AXIS DRO
351161	JMD-45GHPF Geared Head Square Column Mill Drill with Power Downfeed with NEWALL DP500 2-AXIS DRO & X-Axis Powerfeed
351162	JMD-45VSPF Variable Speed Square Column Geared Head Mill Drill with NEWALL DP500 2-AXIS DRO
351163	JMD-45VSPF Variable Speed Square Column Geared Head Mill Drill with NEWALL DP500 2-AXIS DRO & X-Axis Powerfeed
351164	JMD-45VSPFT Variable Speed Geared Head Square Column Mill Drill with Power Downfeed & NEWALL DP500 2-AXIS DRO
351165	JMD-45VSPFT Variable Speed Geared Head Square Column Mill Drill with Power Downfeed & NEWALL DP500 2-AXIS DRO & X-Axis Powerfeed

TOOL KITS

24- PIECE MILLING TOOL KIT FOR R-8 SPINDLE MILLING MACHINES

- 5 pc Wiggler Set
- 5pc 1/2" HSS Boring Bars
- 1pc Drill Drift
- 3pc Edge Finders
- 1pc Arbor JT6 to R8
- 1pc Adapter R8 to MT3
- 1pc 3/4" Shank
- 1pc 3/4" Boring Head
- 3pc. Hex Keys
- 1pc 2-1/2" Fly Cutter
- 1pc 3/8 x 3" Square Tool Bit
- 1pc Blank R8 Arbor



660220

STOCK NUMBER	DESCRIPTION
660220	24- Piece Milling Tool Kit for R-8 Spindle Milling Machines

MILLING ACCESSORY KIT

- 650132 Collet Set CS-R8, 6 pc. R-8 Collet Set 1/8" - 3/4" by 1/8ths for Mills
- 660012 Clamping Kit includes:
 - Metal storage tray can be mounted on machine or wall
 - Three complete sets to choose from
 - 52 pc. Clamping Kit with Tray for 9/16" and 5/8" T-Slot ,
 - 6 Flange nuts and Four coupling nuts
- 660220 Tooling Kit 24 pc. Milling Tool Kit for R8-Spindle Milling Machines

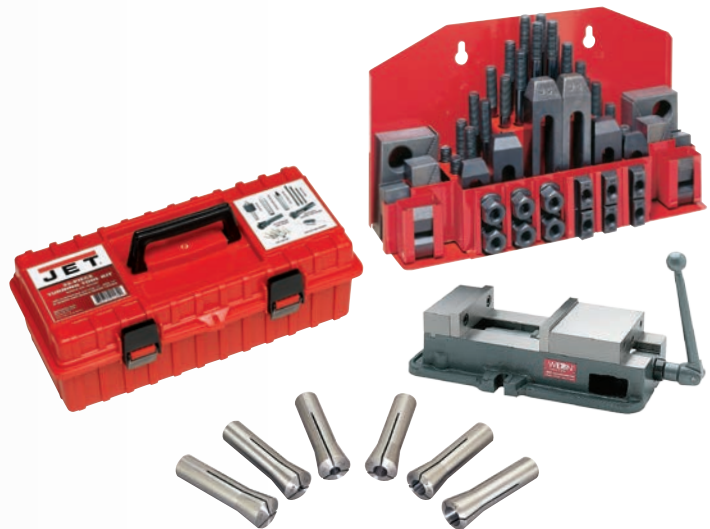

660100KT

STOCK NUMBER	DESCRIPTION
660100KT	Milling Accessory Kit



COLLET AND END MILL SETS

MILLING CHUCK AND COLLET SETS

- 17 pc. set in a wooden case
- Can quickly change from one shank size to another without loosening the draw bar
- 15 precision spring collets take the place of 15 individual adaptors
- Can be used for milling, drilling, reaming and boring operations
- Complete with spanner wrenches
- Collets are in increments of 1/16"
- T.I.R. at 2-3/8" is 0.0008"

STOCK NUMBER	466001
Model Number	CCS-1
Shank Taper	R-8
Capacity (in.)	1/8- 1



R8 COLLET SET

- Precision hardened and ground
- R8 Collets for use on milling machines
- Premium collets with 0.0005mm T.I.R.

STOCK NUMBER	DESCRIPTION
650132	CS-R8, 6 pc. R-8 Collet Set 1/8" - 3/4" by 1/8ths for Mills



TIN COATED END MILL SETS

- TiN (Titanium Nitride) coating provides extreme hardness and heat resistance allowing tool to run at higher speeds and feeds
- Excellent for general-purpose use as TiN provides higher lubricity for freer chip flow, reduced buildup edge formations and catering.
- Square end mill types are used for general milling applications

STOCK NUMBER	DESCRIPTION
650210	20 PC TiN Coated Double End Mill Set 3/16-3/4" by 16ths 1 ea 2 & 4 flute
650211	20 PC TiN Coated Single End Mill Set 3/16-3/4" by 16ths 1 ea 2 & 4 flute



MILLING ACCESSORIES

CLAMPING KITS

- Metal storage tray can be mounted on machine or wall
- Three complete sets to choose from
- 52 pc. kit includes: Six T-slot nuts, Six Flange nuts, Four Coupling nuts, Six Step blocks, Six Step clamps,
- Twenty four Studs, four each (3", 4", 5", 6", 7" & 8" lengths)

STOCK NUMBER	660038	660012	660058
Model Number	CK-38	CK-12	CK-58
Stud Size	3/8" - 16 T.P.I.	1/2" - 13 T.P.I.	5/8" - 11 T.P.I.
T-Slot Sizes (in.)	7/16 and 1/2	9/16 and 5/8	11/16 and 3/4



660012

TABLE AND KNEE POWERFEEDS

- Specially designed for each model
- X-, Y- and Z-axis available
- Provides continuously variable feed rate of up to 32 in./min.
- Adjustable stops allow automatic shut off
- Includes rapid traverse button
- Built-in clutch helps prevent damage in overload
- Factory installation available
- Installation of powerfeed will reduce table travel



STOCK NUMBER	350194	350195	350196
Model Number	TPFA-2XN	TPFA-2YN	TPFA-2Z
Speed Rate/Variable (ipm)	0-32	0-32	0-32
Torque (in./lbs.)	780	780	780
Rapid Traverse (ipm)	32	32	32
Motor (HP)	105W /1AMP, 115V, 1 Ph	105W /1AMP, 115V, 1 Ph	105W /1AMP, 115V, 1 Ph
Net Weight (lbs.)	14	14	14

TO FIT MILL:	STOCK NO. X-AXIS	STOCK NO. Y-AXIS	STOCK NO. Z-AXIS
JVM-836	350194	350195	350196
JTM-1&2	350194	350195	350196
JTM-4VS	350194	350195	350196
JTM-1050	350194	350195	350196
JTM-1050EVS	350194	350195	350196
JTM-1055	350194	350195	350196



MILLING ACCESSORIES

SWING AWAY ADJUSTABLE SAFETY SHIELD

These shields are intended to deflect chips, sparks, coolant or lubricant away from the operator and other employees in the machine area. They offer excellent visibility to the point of operation to help increase worker safety. The adjustable shields easily swing in or out of position.

STOCK NUMBER	DESCRIPTION
A635	Safety Shield

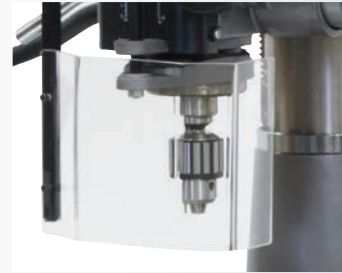

FLOOD COOLANT SYSTEM

Air and coolant line connections are encased in braided metal wire.

STOCK NUMBER	DESCRIPTION
A619	Flood Coolant System for Models 220V/440V, 3Ph



RISER BLOCKS

- Specially designed for each model
- Adds 6" – 8" height capacity
- Includes all mounting hardware

STOCK NUMBER	MILL MODEL	SIZE (in.)
350090	JTM-1&2	6
350090	JTM-4VS	6
350096	JTM-1050	8
350096	JTM-1050EVS	8



AIR POWER DRAWBAR

- Fits all JET variable speed milling machines
- High quality industrial grade air motor
- Double impact high torque design
- Easy installation requires no drilling or tapping
- Air requirements: 3 CFM at 90 PSI

STOCK NUMBER	MILL MODEL
350198K	JTM-4VS
350197K	JTM-949EVS
350193K	JTM-1050
350197K	JTM-1050EVS
350192K	JTM-1254VS
350193K	JTM-1254RVS

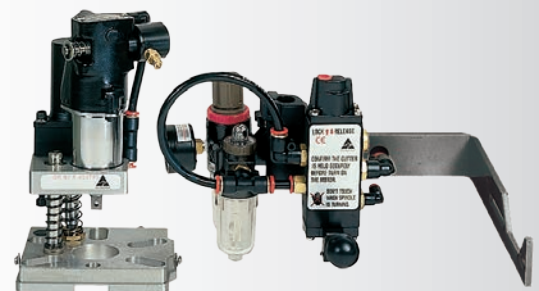

DIGITAL READOUTS



VUE ACU-RITE DRO SERIES

The Acu-Rite VUE is a cost-effective, entry-level solution for manual machine tool applications. With our innovative LCD display screen technology and versatile software to accommodate milling, turning or grinding applications the VUE is everything you need at a price you can afford.

- 1, 2 or 3 axes 5.7" transmissive LCD display
- 200mm fixed reference marks
- Job clock
- Feed rate display
- Multiple language support
- Absolute/incremental
- Near-zero warning

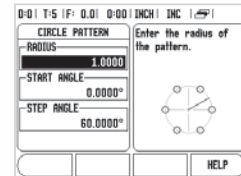

200S ACU-RITE DRO SERIES

As the industry standard in digital readout systems, the Acu-Rite 200S offers state-of-the-art features for milling, turning and grinding applications.

- 2 or 3 axes 5.7" transmissive LCD display
- Position-Trac™ home reference
- Job clock
- Feed rate display
- Multiple language support
- Absolute/incremental
- Near-zero warning

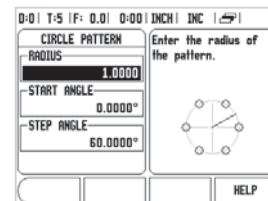
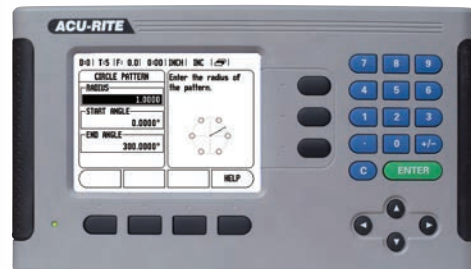

300S ACU-RITE DRO SERIES

The Acu-Rite 300S is a fully programmable 4 axes readout system, now available with a full color display. With the capability to store and create a library of programs the 300S is everything you need to create, edit and execute programs on your manual machine tool..

FEATURES

- 2, 3 or 4 axes 5.7" full color display
- Position-Trac™ home reference
- Multiple program names with numerous steps
- Job clock
- Feed rate display
- Multiple language support
- Absolute/incremental
- Near-zero warning

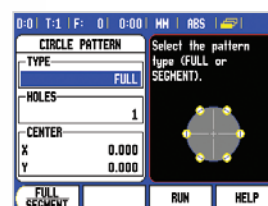
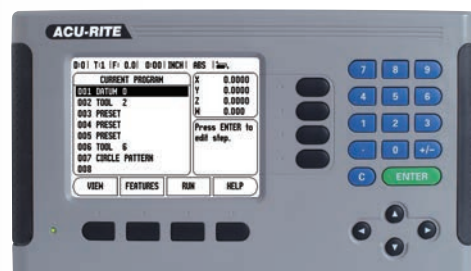

DIGITAL READOUTS

DP700 NEWALL DIGITAL READOUT

The DP700 leads our Newall line of a powerful and intuitive DROs. The unit is housed in a rugged, ergonomically designed casting. The DRO features all of the essential functions for milling, boring, turning, grinding, and general machining operations. The DP700 is compatible with Newall's Spherosyn and Microsyn encoders which withstand the harshest shop conditions.

- Feed rate display
- Bolt hole circle routine
- Line hole routine
- Arc contouring
- Programmable memory/teach
- Polar coordinates
- Line hole calculator
- Tool offsets
- Taper calculations
- Axis vectoring/summing
- Linear and segmented error comp.
- Undo
- RS232 output
- Languages: English, French, German, Spanish, Italian, Turkish, Czech, Russian, Portuguese, Danish
- Clean, crisp, easy-to-read, LEDs
- Intuitive message window
- Long life membrane keypad
- Solid cast construction
- Safe, low voltage power supply (UL)
- Panel mount version available

NEWALL



DP500 NEWALL DIGITAL READOUT

The DP500 is the newest addition to the Newall DRO family. The DP500 comes equipped with Digifind, a feature unique to Newall digital readout products. Digifind eliminates the risk of losing your position and datum Set-Up. With Digifind, precise Setup of a workpiece is carried out only one time.

- Absolute/incremental readings
- Inch/metric instant conversion
- Switchable resolutions
- Center find
- Radius/diameter readings
- Datum preset/zero reset
- Bolt hole circle
- Tool offsets
- Segmented error compensation
- Linear error compensation
- Reference point (Digifind)
- Languages: English, French, German, Spanish, Italian, Turkish, Czech, Russian, Portuguese, Danish



The DP500 Packages come with the new Spherosyn LT or Microsyn LT encoders. These encoders feature the same inductive technology and IP67 rating as Newall's Spherosyn 2G encoders and will provide accurate and dependable readings under the harshest environmental conditions.





DRILLING

The complete line of JET Drill Presses deliver exact spacing and depth control. Engineered durability and enhanced flexibility, the perfect JET Drill Press for both commercial and maintenance operations are available. The industry's leading warranty and professional manuals for efficient operation assures every JET machine user that we back our products so you can put them to work with complete confidence.



CHOOSE YOUR DRILL QUICK REFERENCE GUIDE

STOCK NUMBER	MODEL	DESCRIPTION	TYPE	MOTOR (HP)	SPINDLE TAPER	DRILLING CAPACITY (MILD STEEL)	TAPPING CAPACITY (MILD STEEL)	PAGE NO.
RADIAL DRILLS								
320038	J-1600R,	5' Arm Radial Drill Press	Radial Arm	7-1/2 HP, 230/460V, 3ph	MT-5	2-1/2"	2"	102
320039	J-1600R-4	5' Arm Radial Drill Press	Radial Arm	7-1/2 HP, 460V, 3ph	MT-5	2-1/2"	2"	102
320036	J-1230R	4' Arm Radial Drill Press	Radial Arm	2-1/2 to 5HP, 230V, 3ph	MT-4	1-7/8"	1"	103
320037	J-1230R-4	4' Arm Radial Drill Press	Radial Arm	2-1/2 to 5HP, 460V, 3ph	MT-4	1-7/8"	1"	103
320033	J-720R	3' Arm Radial Drill Press	Radial Arm	3 HP, 230/460V, 3ph	MT-4	1-1/2"	3/4"	104
DIRECT DRIVE ROUND COLUMN DRILL PRESSES								
354052	J-2380	33" Direct Drive Drill Press	Direct Drive	7-1/2 HP, 230/460V, 3 ph	MT-5	2-3/4"		105
354051	J-2360	30" Direct Drive Drill Press	Direct Drive	4 HP, 230/460V, 3 ph	MT-4	2"		105
354050	J-2350	28" Direct Drive Drill Press	Direct Drive	3 HP, 230/460V, 3 ph	MT-4	1-3/4"		105
GEARED HEAD DRILL PRESSES								
354034	J-A3008-2	26" Arboga Gear Head Drill Press	Geared Head	1-1/2 to 2 HP, 220V, 3ph	MT-3	31/32"		106
354035	J-A3008-4	26" Arboga Gear Head Drill Press	Geared Head	1-1/2 to 2 HP, 440V, 3ph	MT-3	31/32"		106
354036	J-A3008M-PF2	25" Arboga Gear Head Drill Press with Powerfeed	Geared Head	1-1/2 to 2 HP, 220V, 3ph	MT-3	1-1/4"		106
354037	J-A3008M-PF4	25" Arboga Gear Head Drill Press with Powerfeed	Geared Head	1-1/2 to 2 HP, 440V, 3ph	MT-3	1-1/4"		106
354030	J-A2608M-PF2	20" Arboga Gear Head Drill Press with Powerfeed	Geared Head	1 to 1-1/2 HP, 220V, 3ph	MT-3	1-1/4"		108
354031	J-A2608M-PF4	20" Arboga Gear Head Drill Press with Powerfeed	Geared Head	1 to 1-1/2 HP, 440V, 3ph	MT-3	1-1/4"		108
354028	J-A2608-2	20" Arboga Gear Head Drill Press	Geared Head	1 to 1-1/2 HP, 220V, 3ph	MT-3	1-1/4"		108
354029	J-A2608-4	20" Arboga Gear Head Drill Press	Geared Head	1 to 1-1/2 HP, 440V, 3ph	MT-3	1-1/4"		108
354027	J-A2608-1	20" Arboga Gear Head Drill Press	Geared Head	1 to 1-1/2 HP, 120V, 1ph	MT-3	3/4"		108
354022	GHD-20T	20" Gear Head Tapping Drill Press	Geared Head	2 HP, 230V, 3ph	MT-3	1-1/4"	15/16"	110
354026	GHD-20PFT	20" Gear Head Tapping Drill Press with Powerfeed	Geared Head	2 HP, 230V, 3ph	MT-3	1-1/4"	15/16"	110
354020	GHD-20	20" Gear Head Drill Press	Geared Head	2 HP, 230V, 3ph	MT-3	1-1/4"		111
354024	GHD-20PF	20" Gear Head Drill Press with Powerfeed	Geared Head	2 HP, 230V, 3ph	MT-3	1-1/4"		111



STOCK NUMBER	MODEL	DESCRIPTION	TYPE	MOTOR (HP)	SPINDLE TAPER	DRILLING CAPACITY (MILD STEEL)	TAPPING CAPACITY (MILD STEEL)	PAGE NO.
ELECTRONIC VARIABLE SPEED DRILL PRESSES								
NEW	354220	JDP-20EVS-110	20" EVS Drill Press	EVS	2 HP, 115V Single Phase	MT-3	1-3/8"	112
NEW	354225	JDP-20EVST-230	20" EVS Drill Press Tapping	EVS	2 HP, 230V 3ph	MT-3	1-3/8" 3/4"	112
NEW	354226	JDP-20EVST-460	20" EVS Drill Press Tapping	EVS	2HP, 460V, 3 ph	MT-3	1-3/8" 3/4"	112
NEW	354245	JDP20EVST-230-PDF	20" EVS GH Powerfeed 230V	EVS	2 HP, 230V 3ph	MT-4	2" 1"	114
NEW	354246	JDP20EVST-460-PDF	20" EVS GH Powerfeed 4	EVS	2 HP, 460V 3ph	MT-4	2" 1"	114
VARIABLE-SPEED DRILL PRESSES								
NEW	354230	JDP-20VS-1	20" VS Drill Press 1-PH	Variable Speed	2HP, 115/ 230V, 1ph	MT-3	1"	116
NEW	354231	JDP-20VS-3	20" VS Drill Press 3-PH	Variable Speed	2HP, 230/ 460V,3ph	MT-3	1-3/8"	116
NEW	354240	JDP20VST	20" HD VS Drill Press with Tapping	Variable Speed	2HP, 230V,3ph	MT-3	1-3/8" 5/8"	116
	354550	J-A5816	15" Variable Speed Floor Model Drill Press	Variable Speed	1 HP, 115/220V, 1ph	MT-2	1/2"	118
	354551	J-A5818	15" Variable Speed Floor Model Drill Press	Variable Speed	1 HP, 230/460V, 3ph	MT-2	1/2"	118
STEP PULLEY DRILL PRESSES								
NEW	354300	IDP-17	17" Industrial Floor Model Drill Press	Step Pulley	1 HP, 115/230V, 1ph	MT-2	5/8"	123
NEW	354301	IDP-22	22" Industrial Floor Model Drill Press	Step Pulley	1-1/2HP, 115/230V, 1ph	MT-3	1 1	123
	354170	JDP-20MF	20" Floor Drill Press	Step Pulley	1-1/2 HP, 115/230V, 1ph	MT-3	3/4"	119
	354402	J-2550	20" Floor Model Drill Press	Step Pulley	1 HP, 115/230V, 1ph	MT-3	5/8"	120
	354400	J-2500	15" Floor Model Drill Press	Step Pulley	3/4 HP, 115V, 1ph	MT-2	1/2"	120
	354401	J-2530	15" Bench Model Drill Press	Step Pulley	3/4 HP, 115V, 1ph	MT-2	1/2"	120
	354500	J-A3816	15" 6-Speed Floor Model Drill Press	Step Pulley	1 HP, 115/230V, 1ph	MT-2	1/2"	122

5' RADIAL ARM DRILL PRESS



320038

DURABILITY

- The spindle is made of the finest case hardened steel for extra strength and wear
- The spindle is supported by double row taper roller and thrust ball bearings at the nose, with thrust and radial axis bearings at the top
- The spindle is built to withstand exceptionally heavy drilling and boring loads and to insure maximum accuracy
- Entire frame is made of Meehanite® and high tensile strength cast iron to handle the heaviest of jobs

SAFETY

- LED machine lamp delivers extra light for more precise drilling
- Push button controls are all reduced to 110V
- Arm raising safety device prevents arm from dropping

EASE OF USE

- The power train gears and spline shaft are made of the finest quality, heat-treated and ground nickel-chrome steel, giving extra strength and smoothness to high torque loads
- Electrical circuits are located in the built-in control box at the rear of the arm. This keeps the controls dust and humidity free while making them easily accessible for maintenance.
- Counter balanced mechanism for spindle return
- 12 speeds/3 feed rates make exotic materials easier to drill, bore and tap
- Centralized control center
- Automatic tool ejector
- Hydraulic head and column clamping
- Column and head movement are independent of each other, providing versatility in horizontal (head) and vertical (column) travel

STANDARD EQUIPMENT

- Coolant pump
- Tool kit
- Box table



STOCK NUMBER	320038	320039
Model Number	J-1600R	J-1600R-4
Drilling Capacity Mild Steel (in.)	2-1/2	2-1/2
Drilling Capacity Cast Iron (in.)	2-5/16	2-5/16
Tapping Capacity Mild Steel (in.)	2	2
Tapping Capacity Cast Iron (in.)	2-3/8	2-3/8
Boring Capacity Steel (in.)	5	5
Boring Capacity Cast Iron (in.)	7-3/8	7-3/8
Column Diameter (in.)	17	17
Distance Column to Spindle (min / in.)	13-3/8	13-3/8
Distance Column to Spindle (max / in.)	62-1/4	62-1/4
Travel of Head Horizontal (in.)	44-7/8	44-7/8
Distance Base to Spindle (min / in.)	15	15
Distance Base to Spindle (max / in.)	63	63
Arm Travel Vertical (in.)	33-15/32	33-15/32
Table Dimensions (L x W x H / in.)	27-1/2 x 19-3/4 x 16	27-1/2 x 19-3/4 x 16
Base Dimensions (L x W x H / in.)	103-1/4 x 40-1/4 x 8	103-1/4 x 40-1/4 x 8
Quill Travel (in.)	14-9/16	14-9/16
Spindle Taper	MT-5	MT-5
Quill Travel w/ Powerfeed engaged (in.)	13	13
Number of Spindle speeds (rpm)	12 (40 - 1920)	12 (40 - 1920)
Quill Down feed Rates (ipr)	6 (.003 - .038 IPR)	6 (.003 - .038 IPR)
Motor (HP)	7-1/2HP, 230V, 3 Ph	7-1/2HP, 460V, 3Ph
Elevating Motor (HP)	2HP	2HP
Coolant Pump Motor (HP)	1/8HP	1/8HP
Machine Height from Floor (in.)	125	125
Overall Dimensions (L x W x H / in.)	116 x 55 x 112	112 x 55 x 116
Net Weight (lbs.)	11000	11000

4' RADIAL ARM DRILL PRESS



320036

DURABILITY

- The spindle is made of the finest case hardened steel for extra strength and wear
- The spindle is supported by double row taper roller and thrust ball bearings at the nose with thrust and radial axis bearings at the top
- The spindle is built to withstand exceptionally heavy drilling and boring loads and to insure maximum accuracy
- Entire frame is made of Meehanite® and high tensile strength cast iron to handle the heaviest of jobs

SAFETY

- LED machine lamp delivers extra light for more precise drilling
- Push button controls are all reduced to 110V

EASE OF USE

- The power train gears and spline shaft are made of the finest quality, heat-treated and ground nickel-chrome steel, giving extra strength and smoothness to high torque loads
- Electrical circuits are located in the built-in control box at the rear of the arm- this keeps the controls dust and humidity free while making them easily accessible for maintenance.
- Column and head movement are independent of each other, providing versatility in horizontal (head) and vertical (column) travel

STANDARD EQUIPMENT

- Coolant pump
- Tool kit
- Box table



STOCK NUMBER	320036	320037
Model Number	J-1230R	J-1230R-4
Drilling Capacity Mild Steel (in.)	1-7/8	1-7/8
Drilling Capacity Cast Iron (in.)	2-5/16	2-5/16
Tapping Capacity Mild Steel (in.)	1	1
Tapping Capacity Cast Iron (in.)	1-1/2	1-1/2
Boring Capacity Steel (in.)	3-3/8	3-3/8
Boring Capacity Cast Iron (in.)	4-3/4	4-3/4
Column Diameter (in.)	11-13/16	11-13/16
Distance Column to Spindle (min / in.)	13-3/4	13-3/4
Distance Column to Spindle (max / in.)	46	46
Travel of Head Horizontal (in.)	35	35
Distance Base to Spindle (min / in.)	19-3/8	19-3/8
Distance Base to Spindle (max / in.)	54	54
Arm Travel Vertical (in.)	35	35
Table Dimensions (L x W x H / in.)	25 x 20-1/2 x 16-5/16	25 x 20-1/2 x 16-5/16
Base Dimensions (L x W x H / in.)	67-3/4 x 28 x 7	67-3/4 x 28 x 7
Quill Travel (in.)	9-7/8	9-7/8
Spindle Taper	MT-4	MT-4
Quill Travel w/ Powerfeed engaged (in.)	9-7/16	9-7/16
Number of Spindle speeds (rpm)	12 (44 - 1500)	12 (44 - 1500)
Quill Down feed Rates (ipr)	3 (.002, .004, .006)	3 (.002, .004, .006)
Motor (HP)	2-1/2 to 5HP, 230V, 3 Ph	2-1/2 to 5HP, 460V, 3 Ph
Elevating Motor (HP)	1HP	1HP
Coolant Pump Motor (HP)	1/8HP	1/8HP
Machine Height from Floor (in.)	109-1/2	109-1/2
Overall Dimensions (L x W x H / in.)	80 x 39 x 89	80 x 39 x 89
Net Weight (lbs.)	4520	4520

3' RADIAL ARM DRILL PRESS



DURABILITY

- The spindle is made of finest case hardened steel, for extra strength and wear
- The spindle is supported by double row taper roller and thrust ball bearings at the nose, with thrust and radial axis bearings at the top
- Build to withstand exceptionally heavy drilling and boring loads to insure maximum accuracy

SAFETY

- LED machine lamp delivers extra light for more precise drilling

EASE OF USE

- The power train gears and spline shafts are made of the finest quality, heat-treated and ground nickel-chrome steel, giving extra strength and smoothness to high torque loads
- Column and head movement are independent of each other, providing versatility in horizontal (head) and vertical (column) travel

STANDARD EQUIPMENT

- Coolant pump
- Tool kit
- Box table

STOCK NUMBER	320033
Model Number	J-720R
Drilling Capacity Mild Steel (in.)	1-1/2
Drilling Capacity Cast Iron (in.)	2
Tapping Capacity Mild Steel (in.)	3/4
Tapping Capacity Cast Iron (in.)	1
Boring Capacity Steel (in.)	2-3/8
Boring Capacity Cast Iron (in.)	4
Column Diameter (in.)	8-1/4
Distance Column to Spindle (min / in.)	8-5/8
Distance Column to Spindle (max / in.)	29-1/2
Travel of Head Horizontal (in.)	20-7/8
Distance Base to Spindle (min / in.)	9-5/8
Distance Base to Spindle (max / in.)	41-3/4
Arm Travel Vertical (in.)	23-13/16
Table Dimensions (L x W x H / in.)	23-5/8 X 17-1/2 X 15
Base Dimensions (L x W x H / in.)	49-5/8 x 25-3/16 x 6-1/4
Quill Travel (in.)	8-21/32
Spindle Taper	MT-4
Quill Travel w/ Powerfeed engaged (in.)	8-1/4
Number of Spindle speeds (rpm)	6 (88 - 1500)
Quill Down feed Rates (ipr)	.002, .004, .006
Motor (HP)	3HP, 230/460V 3Ph, Prewired 230V
Elevating Motor (HP)	1 HP
Coolant Pump Motor (HP)	1/8 HP
Machine Height from Floor (in.)	85-7/16
Overall Dimensions (L x W x H / in.)	64 x 32 x 85
Net Weight (lbs.)	2697



DIRECT DRIVE DRILL PRESSES



354050

DURABILITY

- Heavy-duty quill and spindle
- Coolant system

SAFETY

- Manual quill lock
- Low voltage at switch
- Automatic tool ejector
- Spindle safety shield

EASE OF USE

- Direct drive round column drill press with mechanical clutch
- Two speed forward and reverse switch
- Mechanical powerfeed clutch engagement
- Tempered, ground spindle with internal taper mounted in precision bearings for maximum accuracy, minimizing deflection
- Speed and feed selectors are located on one side of the drill head for convenience and ease of operation
- Oversized base is precision ground with T-slots for added versatility and stability
- Easy-to-read internal depth gauge prevents waste through errors
- Table tilts both right & left and can be rotated 360° around the column for wider work area

STOCK NUMBER	354050	354051	354052
Model Number	J-2350	J-2360	J-2380
Drills to Center of Circle (in.)	28	30	33
Drilling Capacity Cast Iron (in.)	1-7/8	2-5/32	2-7/8
Drilling Capacity Mild Steel (in.)	1-3/4	2	2-3/4
Distance Column to Spindle (in.)	14	15	16-1/2
Range of Spindle Speeds (rpm)	82, 120, 180, 240, 354, 528, 678, 1026, 1524	55, 98, 156, 198, 346, 456, 576, 822, 1338	42, 58, 86, 116, 154, 249, 304, 412, 554, 748, 1098, 1458
Spindle Taper	MT-4	MT-4	MT-5
Spindle Travel (in.)	9	10	11
Spindle Distance to Base (in.)	49	50	51
Spindle Distance to Table (max./in.)	30-1/2	30-1/2	30-1/2
Table Size (in.)	22 x 19	22 x 19	23-1/2 x 23-1/2
T-Slots Number and Size (in.)	2 & 5/8	3 & 5/8	3 & 5/8
Work Table Weight Capacity (lbs.)	400	400	400
Base Dimensions (L x W x H / in.)	102 x 25 x 47	108 x 30 x 53	114 x 33 x 54
Base Slots Number & Size (in.)	2 & 5/8	2 & 5/8	2 & 5/8
Motor (HP)	3HP, 230/460V, 3 Ph, Prewired 230V	4HP, 230/460V, 3 Ph, Prewired 230V	7-1/2HP, 230/460V, 3 Ph, Prewired 230V
Floor Space Required (L x W x H / in.)	40 x 30 x 95	53 x 30 x 108	55 x 33 x 110
Net Weight (lbs.)	1810	2405	3065



25" AND 26" JET/ARBOGA GEARED HEAD DRILL PRESSES

DURABILITY

- Steel column
- Extra long quill movement
- Machined, T-Slotted base plate
- Helical gears for smooth, quiet operation

SAFETY

- CE Certified
- No-volt release prevents spindle start when power returns after shut down
- Fully enclosed spindle
- Telescoping safety spindle guard

EASE OF USE

- Helical gears for smooth quiet operation
- Extra long quill movement
- Adjustable taper bearings mounted in the end of the quill
- Head and table rotate 360° around column
- English/Metric depth gauge
- Drill head and table can be raised and lowered
- Fiber & steel gears which do not required oil bath and allows for easy speed changes
- Quick release drill ejector



354036



STOCK NUMBER	354034	354035	354036	354037
Model Number	J-A3008-2	J-A3008-4	J-A3008M-PF2	J-A3008M-PF4
Drills to Center of Circle (in.)	26	26	25	25
Drilling Capacity Cast Iron (in.)	1-3/16	1-3/16	1-3/16	1-3/16
Drilling Capacity Mild Steel (in.)	31/32	31/32	31/32	31/32
Quill Feed	Manual	Manual	Auto	Auto
Quill Feed Rates (irp)	-	-	.004, .006, .009, .12	.004, .006, .009, .12
Quill Travel (in.)	6	6	6	6
Quill Diameter (in.)	2-7/16	2-7/16	2-7/16	2-7/16
Range of Spindle Speeds (rpm)	90, 190, 320, 530, 640, 1060, 1790, 3610	90, 190, 320, 530, 640, 1060, 1790, 3610	90, 190, 320, 530, 640, 1060, 1790, 3610	90, 190, 320, 530, 640, 1060, 1790, 3610
Spindle Taper	MT-3	MT-3	MT-3	MT-3
Spindle Travel (in.)	6	6	6	6
Spindle Distance to Base (in.)	45-5/8	45-5/8	45-5/8	45-5/8
Spindle Distance to Table (max. / in.)	35	35	35	35
Distance Column to	12-5/8	12-5/8	12-5/8	12-5/8
Spindle (in.)	15-3/4 x 19-3/4	15-3/4 x 19-3/4	15-3/4 x 19-3/4	15-3/4 x 19-3/4
Table Size (in.)	30	30	30	30
Table Travel (in.)	2 & 9/16	2 & 9/16	2 & 9/16	2 & 9/16
T-Slots Number and Size (in.)	450	450	450	450
Work Table Weight Capacity (lbs.)	28 x 24	28 x 24	28 x 24	28 x 24
Base Dimensions (L x W x H / in.)	2 & 9/16	2 & 9/16	2 & 9/16	2 & 9/16
Base Slots Number & Size (in.)	2 & 9/16	2 & 9/16	2 & 9/16	2 & 9/16
Motor (HP)	1-1/2 - 2HP, 220V, 3Ph	1-1/2 - 2HP, 440/460V,3Ph	1/2 - 2HP, 220V, 3Ph	1-1/2 - 2HP, 440/460V, 3Ph
Overall Dimensions (L x W x H / in.)	28 x 24 x 72	28 x 24 x 72	28 x 24 x 72	28 x 24 x 72
Net Weight (lbs.)	565	565	600	600

20" JET/ARBOGA GEARED HEAD DRILL PRESSES



354030

DURABILITY

- Steel column
- 3-15/16" Column diameter
- Helical gears for smooth, quiet operation
- Fiber & steel gears, which do not require oil bath and allow for easy speed changes
- Adjustable taper bearings mounted in the end of the quill
- Extra long quill movement
- Helical gears for smooth, quiet operation

SAFETY

- Safety latch to prevent head dropping when unclamped
- Fully enclosed spindle
- Telescoping safety spindle guard

EASE OF USE

- 2 position High/Low switch
- English/Metric depth gauge
- Head and table rotate 360° around column
- Quick release drill ejector
- Eight spindle speeds
- T-Slotted table with coolant trough
- Drill head and table can be raised and lowered



STOCK NUMBER	354027	354028	354029	354030	354031
Model Number	J-A2608-1	-A2608-2	J-A2608-4	J-A2608M-PF2	J-A2608M-PF4
Drills to Center Circle (in.)	20	20	20	20	20
Drilling Capacity Cast Iron (in.)	4/5	1-3/8	1-3/8	1-3/8	1-3/8
Drilling Capacity Mild Steel (in.)	3/4	1-1/4	1-1/4	1-1/4	1-1/4
Column Diameter (in.)	3-15/16	3-15/16	3-15/16	3-15/16	3-15/16
Distance Column to Spindle (in.)	10	10	10	10	10
Range of Spindle Speeds (rpm)	Low - 130, 260, 420, 840; High-420, 840; High-535, 1070, 1745, 3480	Low-130, 260, 420, 840; High-535, 1070, 1745, 3480	Low-130, 260, 420, 840; High-535, 1070,1745, 3480	Low-130, 260, 420, 840; High-535, 1070,1745, 3480	Low-130, 260, 420, 840; High-535, 1070,1745, 3480
Spindle Taper	MT-3	MT-3	MT-3	MT-3	MT-3
Spindle Travel (in.)	5-1/8	5-1/8	5-1/8	5-1/8	5-1/8
Spindle Distance to Base (in.)	44	44	44	44	44
Spindle Distance to Table (max./in.)	35-5/8	35-5/8	35-5/8	35-5/8	35-5/8
Table Size (in.)	15-3/4 x 19-3/4	15-3/4 x 19-3/4	15-3/4 x 19-3/4	15-3/4 x 19-3/4	15-3/4 x 19-3/4
Quill Feed	Manual	Manual	Manual	Auto	Auto
Quill Feed Rates (ipr)	-	-	-	.0004, .006, .009, 0.012	.0004, .006, .009, .012
Quill Travel	5-1/8	5-1/8	5-1/8	5-1/8	5-1/8
Quill Diameter (in.)	2-3/8	2-3/8	2-3/8	2-3/8	2-3/8
Vertical Movement of Drill Head (in.)	8-5/8	8-5/8	8-5/8	8-5/8	8-5/8
Table Travel (in.)	24-1/2	24-1/2	24-1/2	24-1/2	24-1/2
T-Slots Number and Size (in.)	2 - 9/16	2 & 9/16	2 & 9/16	2 & 9/16	2 & 9/16
Work Table Weight Capacity (lbs.)	350	350	350	350	350
Base Dimensions (L x W x H / in.)	24 x 22	24 x 22	24 x 22	24 x 22	24 x 22
Motor (HP)	3/4 to 1 HP, 120V,1Ph	1 - 1-1/2HP, 220V, 3Ph	1 - 1-1/2HP, 440V,3Ph	1 - 1-1/2HP, 220V,3Ph	1 - 1-1/2HP, 440V, 3Ph
Overall Dimensions (L x W x H / in.)	24 x 22 x 72	24 x 22 x 72	24 x 22 x 72	24 x 22 x 72	24 x 22 x 72
Net Weight (lbs.)	475	475	475	600	600

20" GEARED HEAD DRILL PRESS WITH TAPPING



354022

DURABILITY

- Heavy-duty design allows a variety of precision drilling and tapping applications
- Three power down feeds
- Calibrated fine down feed built-in
- TEFC Motor

SAFETY

- Built-in spindle lock
- Spindle safety shield

EASE OF USE

- Easy-to-read internal depth gauge
- Head tilts left or right
- Easy accessible table raiser
- Large production table and T-slotted base
- Integrated tapping and reversing controls
- Power downfeed speed selector both drilling & tapping with the flick of a switch
- Draw bar
- T-slotted worktable
- Drill chuck arbor

STOCK NUMBER	354022	354026
Model Number	GHD-20T	GHD-20PFT
Drills to Center Circle (in.)	20	20
Drilling Capacity Cast Iron (in.)	1-1/2	1-1/2
Drilling Capacity Mild Steel (in.)	1-1/4	1-1/4
Tapping Capacity Mild Steel (in.)	15/16	15/16
Tapping Capacity Cast Iron (in.)	15/16	15/16
Column Diameter (in.)	4-1/2	4-1/2
Distance Column to Spindle (in.)	10	10
Range of Spindle Speeds (rpm)	120, 260, 460, 900, 1600, 3000, 60, 130, 230, 450, 800, 1500	120, 260, 460, 900, 1600, 3000, 60, 130, 230, 450, 800, 1500
Spindle Taper	MT-3	MT-3
Spindle Travel (in.) Manual	5	4-1/2
Spindle Travel (in.) Auto	N/A	4-1/4
Spindle Distance to Base (in.)	44-5/16	44-5/16
Spindle Distance to Table (max./in.)	30-1/2	30-1/2
Table Size (in.)	21-3/4 x 19-1/2	21-3/4 x 19-1/2
T-Slots Number and Size (in.)	2 & 5/8	2 & 5/8
T-Slot Centers (in.)	9	9
Work Table Weight Capacity (lbs.)	275	275
Base Dimensions (L x W x H / in.)	26 x 18 x 5	26 x 18 x 5
Base Work Table (in.)	15-1/4 x 13	15-1/4 x 13
Base Slots Number & Size (in.)	2 & 5/8	2 & 5/8
Motor (HP)	2HP, 230V, 3Ph, 2-speed	2HP, 230V, 3Ph, 2-speed
Overall Dimensions (L x W x H / in.)	32 x 24 x 71	32 x 24 x 71
Net Weight (lbs.)	700	708



20" GEARED HEAD DRILL PRESSES



354020

DURABILITY

- Heavy-duty design allows a variety of precision drilling applications
- Three power down feeds
- Calibrated fine down feed built-in

SAFETY

- Built-in spindle lock

EASE OF USE

- Easy-to-read internal depth gauge
- Head tilts left or right
- Easy accessible table raiser
- Large production table and T-slotted base
- T-slotted worktable
- Drill chuck arbor
- Draw bar
- Fine feed adjustment knob in easy to reach location
- Depth stop - when set the quill will only advance to the set dept

STOCK NUMBER	354020	354024
Model Number	GHD-20	GHD-20PF
Drills to Center Circle (in.)	20	20
Drilling Capacity Cast Iron (in.)	1-1/2	1-1/2
Drilling Capacity Mild Steel (in.)	1-1/4	1-1/4
Column Diameter (in.)	4-1/2	4-1/2
Distance Column to Spindle (in.)	10	10
Range of Spindle Speeds (rpm)	Low 60, 130, 230, 450, 800, 1500 High 120, 260, 460, 900, 1600, 3000	Low 60, 130, 230, 450, 800, 1500 High 120, 260, 460, 900, 1600, 3000
Spindle Taper	MT-3	MT-3
Number of Powerfeeds (GHD-20PF)	-	3
Spindle Travel (in.) Manual	5	4-1/2
Spindle Travel (in.) Auto	N/A	4-1/4
Spindle Distance to Base (in.)	44-15/16	44-15/16
Spindle Distance to Table (max. / in.)	30-1/2	30-1/2
Table Size (in.)	21-3/4 x 19-1/2	21-3/4 x 19-1/2
T-Slots Number and Size (in.)	2 & 5/8	2 & 5/8
T-Slot Centers (in.)	9	9
Work Table Weight Capacity (lbs.)	275	275
Base Dimensions (L x W x H / in.)	26 x 18 x 5	26 x 18 x 5
Base Work Table (in.)	15-1/4 x 13	15-1/4 x 13
Base Slots Number & Size (in.)	2 & 5/8	2 & 5/8
Motor (HP)	2HP, 230V, 3Ph, 2 Speed	2 HP, 230V, 3 Ph, 2 Speed
Overall Dimensions (L x W x H / in.)	32 x 24 x 71	33 x 29 x 76
Net Weight (lbs.)	660	660



NEW

20" EVS VARIABLE SPEED DRILL PRESSES



354220

DURABILITY

- Steel column prevents column failures prolonging the life of the machine
- Heavy-duty casted head for more accuracy and rigidity
- Large precision ground t-slot production table for easy set ups
- Latest AC inverter variable speed technology
- CSA coolant system with the 3-Phase models only
- Spindle is supported by high quality ball bearings reducing rotational friction while increasing load support

SAFETY

- CSA/CUS: Following strict guidelines and electrical requirements, these JET Drills are CSA/CUS certified
- LED machine lamp delivers extra light for more precise drilling
- Spindle guard protects user from flying debris
- Emergency stop allows for immediate shut off

EASE OF USE

- Variable spindle speeds from 65 -2,000 RPM's
- High torque at all speeds both forward and reverse
- Continuous speed adjustment while in operation
- Front mounted LED spindle RPM readout
- Forward and reverse switch for instant tapping mode
- Front mounted positive control depth stop
- Large hand grips designed with the users comfort in mind

VARIABLE SPEED

- Variable spindle speeds: 65-2,000 RPM's
- Low speeds: 65-540 RPM's
- High speed: 245-2,000 RPM's
- Continuous speed adjustment while in operation

TAPPING

- Available on 354225: JDP-20EVST-230 & 354226: JDP-20EVST-460
- Cast iron 7/8"
- Mild steel 3/4"
- Forward and reverse switch for instant tapping mode

STANDARD EQUIPMENT

- Coolant system (optional on model number JDP-20EVS-110)
- Spindle safety guard
- LED machine lamp



STOCK NUMBER	354220	354225	354226
Model Number	JDP-20EVS-110	JDP-20EVST-230	JDP-20EVST-460
Drills to Center of Circle (in.)	20	20	20
Drilling Capacity Cast Iron (in.)	1-1/2	1-1/2	1-1/2
Drilling Capacity Mild Steel (in.)	1-3/8	1-3/8	1-3/8
Tapping Capacity Cast Iron (in.)	-	7/8	7/8
Tapping Capacity Mild Steel (in.)	-	3/4	3/4
Distance Column to Spindle (in.)	10-7/16	10-7/16	10-7/16
Number of Spindle Speeds	Variable	Variable	Variable
Range of Spindle Speeds (rpm)	65-540 /245-2,000	65-540 /245-2,000	65-540 /245-2,000
Column Diameter (in.)	4-1/2	4-1/2	4-1/2
Spindle Taper	MT-3	MT-3	MT-3
Spindle Travel (in.)	6	6	6
Spindle Distance to Base (in.)	44-1/2	44-1/2	44-1/2
Spindle Distance to Table (max.) (in.)	30-1/4	30-1/4	30-1/4
Table Size (L x W / in.)	22x18-3/4	22x18-3/4	22x18-3/4
Table Working Area (L x W / in.)	18-1/8 x 14-3/4	18-1/8 x 14-3/4	18-1/8 x 14-3/4
Table Travel Effective travel (max. / in.)	20	20	20
T-Slots Number and Size (in.)	3 & 5/8	3 & 5/8	3 & 5/8
T-Slot Centers (in.)	7-7/16	7-7/16	7-7/16
Work Table Weight Capacity (lbs.)	154	154	154
Base Dimensions (in.)	27 x 19	27 x 19	27 x 19
Base Work Area (in.)	14-3/4 x 11-13/16	14-3/4 x 11-13/16	14-3/4 x 11-13/16
Base Slots Number & Size (in.)	2 & 5/8	2 & 5/8	2 & 5/8
Motor (HP)	2 HP, 230V, 1Ph	2 HP, 230V, 3Ph	2 HP, 460V, 3Ph
Inverter	2HP, 115V, Single Phase	M Type 230V, 1/3Ph	M Type 460V, 1/3Ph
Gross Weight (lbs.)	792	792	792

NEW

20" GEARED EVS DRILL PRESSES WITH POWER DOWNFEED



354245

DURABILITY

- Steel column prevents column failures prolonging the life of the machine
- Heavy-duty casted head for more accuracy and rigidity
- Large precision ground t-slot production table for easy set ups
- Latest AC inverter variable speed technology
- CSA certified coolant system
- Spindle is supported by high quality ball bearings reducing rotational friction while increasing load support

SAFETY

- CSA/CUS: Following strict guidelines and electrical requirements, these JET Drills are CSA/CUS certified
- LED machine lamp delivers extra light for more precise drilling
- Spindle guard protects user from flying debris

EASE OF USE

- 3-Speed power downfeed
- Variable spindle speeds from 65 -2,000 RPM's
- High torque at all speeds both forward and reverse
- Continuous speed adjustment while in operation
- Front mounted LED spindle RPM readout
- Forward and reverse for tapping
- Front mounted positive control depth stop
- Large hand grips designed with the users comfort in mind

TAPPING CAPACITY

- Cast Iron: 1"
- Mild Steel: 1"

POWER DOWNFEED

- Power downfeed now available on EVS Drill Presses
- Quill downfeed rates (ipr): .0078 - .0039 - .0019



STOCK NUMBER	354245	354246
Model Number	JDP-20EVST-230-PDF	JDP-20EVST-460-PDF
Drills to Center of Circle (in.)	20	20
Drilling Capacity Cast Iron (in.)	2-5/32	2-5/32
Drilling Capacity Mild Steel (in.)	2	2
Tapping Capacity Cast Iron (in.)	1	1
Tapping Capacity Mild Steel (in.)	1	1
Distance Column to Spindle (in.)	10-7/16	10-7/16
Number of Spindle Speeds	Variable	Variable
Range of Spindle Speeds (rpm)	60-2,000 (60-540/225-2000)	60-2,000 (60-540/225-2000)
Quill Down Feed Rates (ipr)	.0078-.0039 -.0019	.0078-.0039 -.0019
Column Diameter (in.)	4-1/2	4-1/2
Spindle Taper	MT-4	MT-4
Spindle Travel (in.)	6	6
Spindle Distance to Base (in.)	44.68	44.68
Spindle Distance to Table (max. / in.)	25.5	25.5
Table Size (L x W / in.)	22x18-3/4	22x18-3/4
Table Working Area (L x W / in.)	18-1/8 x 14-3/4	18-1/8 x 14-3/4
Table Travel Effective travel (max. / in.)	20	20
T-Slots Number and Size (in.)	3 & 5/8	3 & 5/8
T-Slot Centers (in.)	7-7/1	7-7/16
Work Table Weight Capacity (lbs.)	154	154
Base Dimensions (in.)	27 x 19	27 x 19
Base Work Area (in.)	14-3/4 x 11-13/16	14-3/4 x 11-13/16
Base Slots Number & Size (in.)	2 & 5/8	2 & 5/8
Motor (HP)	2 HP, 230V, 3Ph	2 HP, 460V, 3Ph
Inverter	B Type 230V, 1/3Ph	B Type 230V, 3Ph
Gross Weight (lbs.)	847	847

NEW

20" VARIABLE SPEED DRILL PRESSES

DURABILITY

- Steel column
- Heavy-duty casted iron design
- Head is massively constructed for more accuracy and rigidity
- Large precision ground t-slot production table for easy set ups
- Massive 3" quill diameter
- Coolant system standard on JDP-20VST

SAFETY

- CSA/CUS: Following strict guidelines and electrical requirements, these JET Drills are CSA/CUS certified
- LED machine lamp
- Spindle guard

EASE OF USE

- Variable spindle speeds from 65 - 2,000 RPM's
- Front mounted LED spindle RPM readout
- Front mounted positive control depth stop
- Table rotates 360° around the column
- Machine t-slotted base
- Large hand grips designed with the users comfort in mind



354230

OPTIONAL EQUIPMENT	STOCK NUMBER
Coolant System 115/230V Single Ph for JDP-20VS-1	5512104
Coolant System 220/440V 3-Ph for JDP-20VS-3	5508071



STOCK NUMBER	354230	354231	354240
Model Number	JDP-20VS-1	JDP-20VS-3	JDP-20VST
Drills to Center of Circle (in.)	20	20	20
Drilling Capacity Cast Iron (in.)	1-1/4	1-1/2	1-1/2
Drilling Capacity Mild Steel (in.)	1	1-3/8	1-3/8
Tapping Capacity Cast Iron (in.)	N/A	N/A	3/4
Tapping Capacity Mild Steel (in.)	N/A	N/A	5/8
Distance Column to Spindle (in.)	10-7/16	10-7/16	10-7/16
Number of Spindle Speeds	Variable	Variable	Variable
Range of Spindle Speeds (rpm)	300 - 2,000	300 - 2,000	150 - 2,000
Column Diameter (in.)	4-1/2	4-1/2	4-1/2
Spindle Taper	MT-3	MT-3	MT-3
Spindle Travel (in.)	6	6	6
Spindle Distance to Base (in.)	44-1/2	44-1/2	44-1/2
Spindle Distance to Table (max. / in.)	30-1/4	30-1/4	30-1/4
Table Size (L x W / in.)	22 x 18-3/4	22 x 18-3/4	22 x 18-3/4
Table Working Area (L x W / in.)	18-1/8 x 14-3/4	18-1/8 x 14-3/4	18-1/8 x 14-3/4
Table Travel Effective travel (max. / in.)	20	20	20
T-Slots Number and Size (in.)	3 & 5/8	3 & 5/8	3 & 5/8
T-Slot Centers (in.)	7-7/16	7-7/16	7-7/16
Work Table Weight Capacity (lbs.)	154	154	154
Base Dimensions (in.)	27 x 19	27 x 19	27 x 19
Base Work Area (in.)	14-3/4 x 11-13/16	14-3/4 x 11-13/16	14-3/4 x 11-13/16
Base Slots Number & Size (in.)	2 & 5/8	2 & 5/8	2 & 5/8
Motor (HP)	2HP, 115/ 230V, 1Ph ,4P	2HP, 230/ 460V,3Ph ,4P	2HP, 230V,3Ph ,4/8P
Gross Weight (lbs.)	780	780	780

15" VARIABLE SPEED DRILL PRESSES



DURABILITY

- Large 2-1/4" quill allows greater accuracy
- 3" column diameter for maximum head support
- Full bearing support on quill for maximum spindle stiffness
- 6" stroke for deep hole application
- Accurate depth stop for precise hole depths
- 1/2" drill chuck & arbor

SAFETY

- CSA/CUS: Following strict guidelines and electrical requirements, these JET Drills are CSA/CUS certified
- Safety collar

EASE OF USE

- Speeds from 400 to 5000 RPM
- Handwheel adjustment sets the speeds

STANDARD EQUIPMENT

- 1/2" Drill chuck & arbor included
- Easy-to-read LED speed display

STOCK NUMBER	354550	354551
Model Number	J-A5816	J-A5818
Drills to Center Circle (in.)	15	15
Drilling Capacity Cast Iron (in.)	5/8	5/8
Drilling Capacity Mild Steel (in.)	1/2	1/2
Column Diameter (in.)	3	3
Distance Column to Spindle (in.)	7-1/2	7-1/2
Spindle Travel (in.)	6	6
Spindle Distance to Base (in.)	44-1/2	44-1/2
Max Distance Spindle to Table (in.)	25-3/4	25-3/4
Table Size (in.)	15 x 18	15 x 18
Table Travel (in.)	16-3/4	16-3/4
T-Slots Number and Size (in.)	2 & 1/2	2 & 1/2
T-Slot Centers (in.)	5-5/16	5-5/16
Work Table Weight Capacity (lbs.)	90	90
Spindle Taper	MT-2	MT-2
Range of Spindle Speeds (rpm)	400 - 5000	400 to 5000
Base Dimensions (L x W x H / in.)	20-7/16 x 14-3/16 x 3-1/8	20-7/16 x 14-3/16 x 3-1/8
Base Work Table (in.)	12-1/8 x 11-13/16	12-1/8 x 11-13/16
Base Slots Number & Size (in.)	2 & 1/2	2 & 1/2
Motor (HP)	1HP, 115/230V, 1Ph (Prewired 115V)	1HP, 230/460V, 3Ph (Prewired 230V)
Overall Dimensions (L x W x H / in.)	30 x 20 x 71	30 x 20 x 71
Net Weight (lbs.)	426	426



20" FLOOR DRILL PRESS



DURABILITY

- Spindle is supported by high quality ball bearings reducing rotational friction while increasing load support
- Hinged metal belt and pulley cover coupled with quick adjustment motor mount allow rapid changing of spindle speeds
- Adjustable tension spindle return spring
- Large cast iron head

SAFETY

- On/off switch located on front of the drill press head
- Spindle guard
- Built-in work lamp

EASE OF USE

- 1/2" diameter external positive depth stop with three nut locking feature for quick adjustment
- Adjustable tension spindle return spring
- Rotating, 45° tilting, crank-operated worktable with quick release clamp
- Drill chuck and key included



STOCK NUMBER	354170
Model Number	JDP-20MF
Drills to Center Circle (in.)	20
Drilling Capacity Cast Iron (in.)	1
Drilling Capacity Mild Steel (in.)	3/4
Column Diameter (in.)	3-3/8
Distance Column to Spindle (in.)	10
Number of Speeds	12
Range of Spindle Speeds (rpm)	150-4200
Spindle Travel (in.)	4-5/8
Spindle Distance to Base (in.)	46-3/4
Max Distance Spindle to Table (in.)	29-1/8
Table Size (in.)	18-1/2 x 16
T-Slots Number and Size (in.)	6 & 1/2
T-Slot Centers (in.)	3-1/2
Work Table Weight Capacity (lbs.)	80
Spindle Taper	MT-3
Base Dimensions (L x W x H / in.)	13-3/4 x 22-3/4
Base Work Table (in.)	13 x 8-1/2
Base Slots Number & Size (in.)	2 & 5/8
Motor (HP)	1-1/2HP, 115/230V, 1Ph (Prewired 115V)
Overall Dimensions (L x W x H / in.)	31-1/2 x 18-1/2 x 66
Net Weight (lbs.)	282

15" AND 20" STEP PULLEY DRILL PRESSES

DURABILITY

- All models have a cast iron head for better drilling accuracy
- Head casting features a permanently lubricated ball bearing spindle assembly, using four heavy-duty ball bearings mounted in an enclosed quill for extended life
- Massive T-slotted production work table (Model J-2550 only)
- Large ground steel column diameter for maximum head and table support
- J-2550 has a massive T-slot production work table and base

SAFETY

- CSA/CUS: Following strict guidelines and electrical requirements, these JET Drills are CSA/CUS certified
- Spindle guard

EASE OF USE

- Large quill allows greater accuracy
- Table tilts 45°
- 3-1/8" stroke for deep hole applications (4-3/4" on model J-2550)
- Accurate depth stop for precise hole depths

STANDARD EQUIPMENT

- 5/8" Drill chuck and arbor
- Spindle guard



354400

354402



STOCK NUMBER	354401	354400	354402
Model Number	J-2530	J-2500	J-2550
Drills to Center Circle (in.)	15	15	20
Drilling Capacity Cast Iron (in.)	5/8	5/8	3/4
Drilling Capacity Mild Steel (in.)	1/2	1/2	5/8
Column Diameter (in.)	2-7/8	2-7/8	3-5/8
Distance Column to Spindle (in.)	7-1/2	7-1/2	10-1/2
Number of Speeds	16	16	12
Range of Spindle Speeds (rpm)	200, 290, 350, 430, 500, 580, 640, 720, 800, 870, 1440, 1630, 1820, 2380, 2540, 3630	200, 290, 350, 430, 500, 580, 640, 720, 800, 870, 1440, 1630, 1820, 2380, 2540, 3630	150, 260, 300, 440, 490, 540, 1150, 1550, 1840, 2220, 2950, 4200
Spindle Travel (in.)	3-3/8	3-3/8	4-3/4
Spindle Distance to Base (in.)	24	48	43-1/2
Spindle Distance to Table (max. / in.)	15-1/2	24	24
Table Size (in.)	11-1/2 x 11-1/2	11-1/2 x 11-1/2	18-1/2 x 16-1/2
Table Travel (in.)	15-1/2	24	21-1/2
T-Slots Number and Size (in.)	N/A	N/A	3 x 1/2
T-Slot Centers (in.)	N/A	N/A	4
Work Table Weight Capacity (lbs.)	44	44	66
Spindle Taper	MT-2	MT-2	MT-3
Base Dimensions (L x W / in.)	18 x 10-1/2	11 x 19-1/2	22-3/4 x 17-3/4
Base Work Table (in.)	8 x 8	7 x 7-1/2	13 x 14-1/2
Motor (HP)	3/4HP, 115V, 1Ph,	3/4HP, 115V, 1Ph	1 HP, 115/230V, 1Ph, Prewired 115V
Overall Dimensions (L x W x H / in.)	31 x 13 x 39-1/2	31 x 13 x 63	33-1/2 x 18-1/2 x 67
Net Weight (lbs.)	157	167	304

15" 6-SPEED DRILL PRESS



DURABILITY

- 3" column for head support, while the quill is also supported to lessen deflection
- Constructed to provide a solid base for drilling
- Large production work table gives the operator the room to work and support for the job

SAFETY

- Drill chuck guard

EASE OF USE

- Offers a greater range in spindle speeds than others in this class
- Larger quill provides greater accuracy
- 6-Speeds
- 1/2" Drill chuck and arbor standard

STOCK NUMBER	354500
Model Number	J-A3816
Drills to Center Circle (in.)	15
Drilling Capacity Cast Iron (in.)	5/8
Drilling Capacity Mild Steel (in.)	1/2
Column Diameter (in.)	3
Distance Column to Spindle (in.)	15
Range of Spindle Speeds (rpm)	375, 625, 1125, 1950, 3400, 5000
Spindle Travel (in.)	6
Spindle Distance to Base (in.)	44-1/2
Max Distance Spindle to Table (in.)	25-3/4
Table Size (in.)	15 x 18
Table Travel (in.)	16-3/4
T-Slots Number and Size (in.)	2 & 1/2
T-Slot Centers (in.)	5-5/16
Work Table Weight Capacity (lbs.)	90
Spindle Taper	MT-2
Base Dimensions (L x W x H / in.)	20-7/8 x 14-3/16 x 3-1/8
Base Work Table (in.)	12-1/8 x 1-13/16
Base Slots Number & Size (in.)	2 & 1/2
Motor (HP)	1HP, 115/230V, 1Ph, Prewired 115V
Overall Dimensions (L x W x H / in.)	30 x 20 x 71
Net Weight (lbs.)	394



NEW

INDUSTRIAL BELT DRILL PRESSES



354301

DURABILITY

- Heavy-duty construction
- Cast iron table and base
- Table ground for accuracy

SAFETY

- CSA/CUS: Following strict guidelines and electrical requirements, these JET Drills are CSA/CUS certified
- LED machine lamp
- Spindle guard
- On/off switch located on front of the drill press head
- Spindle is supported by high quality ball bearings reducing rotational friction while increasing load support and move up to durability

EASE OF USE

- Large hand grips designed with the users comfort in mind
- Hinged metal belt and pulley cover coupled with quick adjustment motor mount allow rapid changing of spindle speeds
- Rotating, 45° tilting, crank-operated worktable with quick release clamp
- 1/2" diameter external positive depth stop with three nut locking feature for quick adjustment
- Adjustable tension spindle return spring
- Drill chuck and key attach to the side of the drill press always within reach of the operator

STANDARD EQUIPMENT

- Ground table
- Drill chuck and key

STOCK NUMBER	354300	354301
Model Number	IDP-17	IDP-22
Drills to Center of Circle - Swing (in)	16-7/8	21-7/8
Drilling Capacity Cast Iron (in.)	3/4	1-1/4
Drilling Capacity Mild Steel (in.)	5/8	1
Column Diameter (in.)	3-1/8	3-5/8
Distance Column to Spindle (in.)	8-3/8	10-7/8
Number of Spindle speeds	12	12
Range of Spindle Speeds (rpm)	350-2800	175-3050
Spindle Travel (in.)	3-5/16	4-13/16
Spindle Distance to Base (in.)	50	48-1/2
Distance Spindle to Table (max. / in.)	30-1/2	28
Spindle Taper	MT-2	MT-3
Quill Diameter (in.)	2-1/16	2-5/8
Chuck Size (in.)	5/8	5/8
Table Size (in.)	14 x 14	18-5/8 x 16-1/8
T-Slots Number and Size (in)	1/2" & 2	5/8" & 3
T-Slot Centers (in.)	9/16	3/4
Work Table Weight Capacity (lbs.)	110	176
Base Work Table area (in.)	16-15/16 x 10-13/16	21-1/2 x 18-5/16
Base Slots Number & Size (in.)	1/2" & 2	5/8" & 2
Base Dimensions (L x W x H / in.)	21-3/4 x 13-3/4 x 2-3/16	22-5/8 x 19-7/16 x 3-3/8
Motor (HP)	1HP, 115/230V, Single Phase	1-1/2HP, 115/230V, Single Phase
Prewired	115V	115V
Net Weight (lbs.)	231	319
Gross Weight (lbs.)	260	364



ACCESSORIES

TAPER MOUNT DRILL CHUCKS

- All components are heat-treated high grade alloy steel
- Chuck jaws are precision fitted to withstand 115 PSI of torque
- All models meet JIS specifications: B4634E



STOCK NUMBER	561702	561704	561706	561708	561709
Model Number	TDC-375	TDC-500	TDC-501	TDC-625	TDC-750
Capacity (in.)	0 - 3/8	0 - 1/2	0 - 1/2	1/8 - 5/8	1/8 - 3/4
Taper Mount	JT-2	JT-6	JT-33	JT-3	JT-4
Body Diameter (in.)	1/15/32	1/5/08	1/25/32	2/3/16	2/7/08
Overall Length (in.)	2/3/08	2-31/32	3/1/08	3/11/16	5

MORSE TAPER TO JACOBS TAPER MOUNT DRILL CHUCK ARBORS

- Precision hardened and ground high grade alloy steel
- All sizes with drift tang

STOCK NUMBER	MODEL	NUMBER SIZE
561763	DCA-22	MT-2 x JT-2
561764	DCA-233	MT-2 x JT-33
561765	DCA-26	MT-2 x JT-6
561766	DCA-233	MT-2 x JT-3
561770	DCA-32	MT-3 x JT-2
561771	DCA-333	MT-3 x JT-33
561772	DCA-36	MT-3 x JT-6
561773	DCA-333	MT-3 x JT-3
561774	DCA-34	MT-3 x JT-4



DRILLING HELPFUL INFO

JET wants to make your job easier by providing basic and helpful information on all of our Drilling machines and accessories, as well as drilling in general.

OVERVIEW

Drilling machines or drill presses are one of the most common machines found in the machine shop. A drill press is a machine that turns and advances a rotary tool into a workpiece. The drill press is used primarily for drilling holes, but when used with the proper tooling, it can be used for a number of machining operations. The most common machining operations performed on a drill press are drilling, reaming, tapping, counterboring, countersinking, and spotfacing.

There are many different types or configurations of drilling machines, but most drilling machines will fall into four broad categories: upright sensitive, upright, radial, and special purpose.

Basically the parts of a drill press are a base, table, column, spindle and drill head. And it drills holes accurately and consecutively. This is because of the spindle's perfect alignment in proportion to the table.

HOW TO MEASURE A DRILL PRESS

A drill press is not measured for height, but capacity. The dimensions to consider are the chuck size, the distance between the drill chuck and table and the distance from the spindle center to the support column.

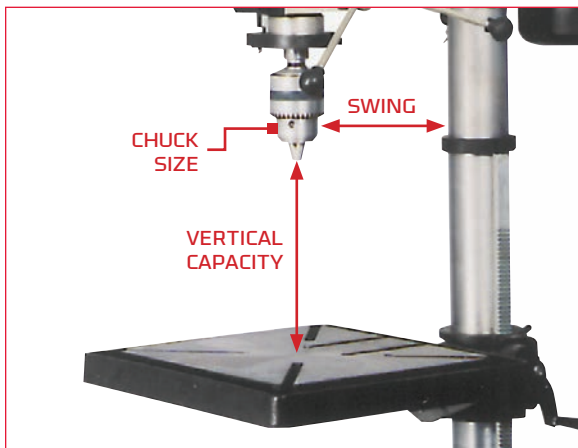

Note: The measurement of twice the swing is the size of the drill press. Example: A drill press with 6" swing is a 12" Drill Press. The swing is double to show the largest circle a machine drills to center.



COMMON DRILL TERMINOLOGY

- | | |
|--------------------------|---------------|
| A STOP AND START BUTTONS | F TABLE |
| B SPINDLE | G TABLE CLAMP |
| C DRILL CHUCK | H COLUMN |
| D HAND FEED LEVER | I BASE |
| E MOTOR | |





GRINDING AND FINISHING

For a high-quality finish every time, the pros rely on JET grinders, sanders and finishing machines. Because your complete satisfaction is our main objective, JET Bench Grinders, Sanders and Finishing machines are built to last and exceed your expectations. Professionally written manuals enable more efficient use, and every JET machine is backed by our industry-leading two-year warranty.



CHOOSE YOUR GRINDING OR FINISHING QUICK REFERENCE GUIDE

STOCK NUMBER	MODEL NUMBER	DESCRIPTION	BELT SIZE (W X L /in.)	BELT SPEED (sfpm)	DISC SIZE (in.)	DISC SPEED (RPM)	TYPE	MOTOR (HP)	PAGE NUMBER	
COMBINATION BELT AND DISC MACHINES										
414551	J-4200A	6" x 48" Industrial Combination Belt and Disc Finishing Machine	6 x 48	2,850	12	1,960	Floor	1-1/2 HP, 115V, 1Ph	130	
414552	J-4200A-2	6" x 48" Industrial Combination Belt and Disc Finishing Machine	6 x 48	2,850	12	1,960	Floor	1-1/2 HP, 230V, 1Ph	130	
414553	J-4202A	6" x 48" Industrial Combination Belt and Disc Finishing Machine	6 x 48	2,850	12	1,960	Floor	1-1/2 HP, 230V, 3Ph	130	
414550K	J-4210K	6" x 48" Belt & Disc Sander	6 x 48	1,650	10	2,100	Bench	1 HP, 115V, 1Ph	131	
577003	J-4002	1" x 42" Bench Belt and Disc Sander	1 x 42	3,000	8	1,725	Bench	1/3 HP, 115V, 1Ph	132	
577004	J-41002	2" x 42" Bench Belt & Disc Sander	2 x 42	3,100	8	1,645	Bench	3/4 HP, 115V, 1Ph	133	
BELT FINISHING MACHINES										
414600	J-4300A	6" x 48" Industrial Belt Finishing Machine	6 x 48	2,850	-	-	Floor	1-1/2 HP, 115/230V, 1Ph	134	
414601	J-4301A	6" x 48" Industrial Belt Finishing Machine	6 x 48	2,850	-	-	Floor	1-1/2 HP, 230V, 3Ph	134	
414610	BG-379-1	3" x 79" Belt Grinder	3 x 79	6,600	-	-	Floor	4 HP, 220V, 1Ph	135	
414615	BG-379-3	3" x 79" Belt Grinder	3 x 79	6,600	-	-	Floor	4 HP, 220V, 3Ph	135	
577000	J-4103	2" x 72" Square Wheel Belt Grinder	2 x 72	4,600	-	-	Bench	1HP, 115/230V, 1Ph	136	
NEW	577100	BGB-142	1" x 42" 3-Wheel Belt Grinder	1 x 42	5,500	-	-	Bench	3/4 HP, 115/230V, 1Ph	137
NEW	577125	BGB-248	2" x 48" 3-Wheel Belt Grinder	2 x 48	6,000	-	-	Bench	1 HP, 115/230V, 1Ph	137
NEW	577150	BGB-260-1	2" x 60" 3-Wheel Belt Grinder	2 x 60	8,000	-	-	Bench	1-1/2 HP, 115/230V, 1Ph	137
NEW	577153	BGB-260-1	2" x 60" 3-Wheel Belt Grinder	2 x 60	8,000	-	-	Bench	3 HP, 230/460V, 3Ph	137
DISC SANDER MACHINES										
577010	J-4421-2	20" Disc Grinder	-	-	20	1,725	Floor	3 HP, 220V, 3Ph	138	
577011	J-4421-4	20" Disc Grinder	-	-	20	1,725	Floor	3 HP, 460V, 3Ph	138	
414602	J-4400A	12" Industrial Disc Finishing Machine	-	-	12	1,960	Floor	1-1/2 HP, 115/230V, 1Ph	139	



STOCK NUMBER	MODEL NUMBER	DESCRIPTION	BELT SIZE (W X L /in.)	BELT SPEED (sfpm)	DISC SIZE (in.)	DISC SPEED (RPM)	TYPE	MOTOR (HP)	PAGE NUMBER	
INDUSTRIAL BENCH GRINDERS										
577101	JBG-6A	6" Shop Bench Grinder	1/2	6 x 3/4	36 / 60	3,450	Bench	1/2 HP, 115V, 1Ph	144	
577102	JBG-8A	8" Shop Bench Grinder	5/8	8 x 1	36 / 60	3,450	Bench	1 HP, 115V, 1Ph	144	
577103	JBG-10A	10" Shop Bench Grinder	1	10 x 1	24 / 46	1,725	Bench	1-1/2 HP, 115V, 1Ph	144	
578008	IBG-8	8" Industrial Bench Grinder	5/8	8 x 1	36, 60	3,450	Bench	1 HP, 115V, 1Ph	142	
578010	IBG-10	10" Industrial Bench Grinder	1	10 x 1	36, 60	1,720	Bench	1-1/2 HP, 115V, 1Ph	142	
578012	IBG-12	12" Industrial Bench Grinder	1 1/4	12 x 2	36, 60	1,720	Bench	2 HP, 230V, 1Ph	142	
NEW	578208	IBG-8VS	8" Variable Speed Industrial Bench Grinder	5/8	8 x 1	36 / 60	900 ~ 3600	Bench	1HP, 50/60Hz, 3Ph	140
INDUSTRIAL VARIABLE SPEED BENCH BUFFERS										
NEW	578218	IBG-8VSB	8" Variable Speed Industrial Bench Buffer	5/8	8 x 1	N/A	900 ~ 3,600	Bench	1HP, 50/60Hz, 3Ph	141
METAL DUST COLLECTOR										
414700	JDC-501	Cabinet Dust Collector For Metal	-	-	-	-	Cabinet	1-1/2 HP, 115V, 1Ph	146	
414800	JDCS-505	Metal Dust Collection Stand	-	-	-	-	Floor	1/2 HP, 115V, 1Ph	147	

INDUSTRIAL COMBINATION 6" x 48" BELT AND 12" DISC FINISHING MACHINE



414551

DURABILITY

- Powered by a heavy-duty 1-1/2HP TEFC motor
- Fully machined, balanced disc runs vibration free
- Adjustable heavy-duty cast iron removable platen
- Heavy-duty one-piece steel stand
- Large cast iron slotted table

SAFETY

- Completely enclosed drums and a guarded sanding belt
- Adjustable dust collector and dust chute

EASE OF USE

- Belt operates at any angle
- Contour finishing, mitering, flat finishing, beveling, and precision finishing
- Variable position locks, belt head adjusts vertically, horizontally, and in between
- Plain and compound miters are easily obtained by using the standard die cast aluminum miter gauge
- Removable upper guard for contour finishing
- Large locking nut and table angle scale
- 60 Grit Belt & Disk come standard for a multitude of uses

STOCK NUMBER	414551	414552	414553
Model Number	J-4200A	J-4200A-2	J-4202A
Disc Size (in.)	12	12	12
Disc Speed (rpm)	1,960	1,960	1,960
Belt Size (W x L / in.)	6 x 48	6 x 48	6 x 48
Belt Speed (sfpm)	2,850	2,850	2,850
Disc Table Size (L x W / in.)	12 x 16-3/8	12 x 16-3/8	12 x 16-3/8
Table Slots (in.)	3/8 x 3/4	3/8 x 3/4	3/8 x 3/4
Disc Table Tilt (deg.)	45° out and 20° in	45° out and 20° in	45° out and 20° in
Motor (HP)	1-1/2HP, 115V, 1Ph	1-1/2HP, 230V, 1Ph	1-1/2HP, 230V, 3Ph
Overall Dimensions (L x W x H / in.)	26 x 19 x 58	26 x 19 x 58	26 x 19 x 58
Net Weight (lbs.)	250	250	250



6" x 48" COMBINATION BELT AND 10" DISC MACHINE

DURABILITY

- Two cast iron-tilting tables for mitering applications
- Heavy-duty one-piece steel stand

SAFETY

- Enclosed base protects motor from dust and debris
- Dust collection shrouds on belt and disc
- Removable safety key switch

EASE OF USE

- Quick-release tension mechanism makes belt changes quick and easy
- Full access to the belt when tilted in the horizontal position
- Belt tensioning lever
- 2" dust chute
- Miter gauge turns and locks for common angles



STOCK NUMBER	414550K
Model Number	J-4210K
Disc Size (in.)	10
Disc Speed (rpm)	2,100
Belt Size (W x L / in.)	6 x 48
Belt Speed (sfpm)	1,650
Disc Table Size (L x W/in.)	7-1/2 x 13
Table Slots (in.)	5/8
Disc Table Tilt (deg.)	45 out
Motor (HP)	1HP, 115V, 1Ph
Overall Dimensions (L x W x H / in.)	23 x 26 x 61
Net Weight (lbs.)	170



1" x 42" BENCH BELT AND 8" DISC SANDER



DURABILITY

- Cast iron tilting table
- Cast construction
- Heavy-duty steel base with rubber feet

SAFETY

- Adjustable dust deflector and dust chute

EASE OF USE

- Miter gauge turns and locks for common angles 45° left and right
- Removable platen allows for sanding, grinding or finishing of outside curves or odd shaped work pieces on the belt
- Hinged idler wheel cover
- Abrasive belt unit does the work of a jigsaw, coping saw or hand file while removing material and finishing at the same time, allows the operator to get into small openings plus handle odd shapes and angles
- Adjustable dust deflector and dust chute

STOCK NUMBER	
Model Number	577003
Model Number	J-4002
Disc Diameter (in.)	8
Disc Speed (rpm)	1,725
Belt Size (W x L / in.)	1 x 42
Belt Speed (sfpm)	3,000
Disc Table Size (in.)	4 x 10
Table Slots (in.)	5/8
Disc Table Tilt (deg.)	45° out
Motor (HP)	1/3HP, 115V, 1Ph
Overall Dimensions (L x W x H / in.)	21 x 22 x 14
Net Weight (lbs.)	62



2" x 42" BENCH BELT AND 8" DISC SANDER



DURABILITY

- Hinged idler wheel cover
- Cast iron tilting table with adjustment handle
- Cast construction
- Heavy-duty steel base and rubber feet

SAFETY

- Dust deflector and chute

EASE OF USE

- Deluxe miter gauge that turns and locks for common angles, 45° both left and right
- Allows for sanding, grinding or finishing of outside, curves or odd shaped work pieces on the belt
- Abrasive belt unit does the work of a jig saw, coping saw or hand file while removing material and finishing at the same time, allows the operator to get into small openings, plus handle odd shapes and angles
- Removable platen
- Belt tensioning handle

STOCK NUMBER	577004
Model Number	J-41002
Disc Diameter (in.)	8
Disc Speed (rpm)	3,450
Belt Size (W x L / in.)	2 x 42
Belt Speed (sfpm)	3,100
Disc Table Size (in.)	10-3/4 x 7-1/2
Disc Table Tilt (deg.)	45° out
Motor (HP)	3/4HP, 115V, 1Ph
Overall Dimensions (L x W x H / in.)	20-1/2 x 22-3/4 x 20
Net Weight (lbs.)	60



6" x 48" INDUSTRIAL BELT FINISHING MACHINE



414600

DURABILITY

- Adjustable heavy-duty cast iron removable platen
- Heavy-duty one-piece steel stand

SAFETY

- Completely enclosed drums and a guarded sanding belt
- Adjustable dust deflector for and dust chute

EASE OF USE

- Table tilts 45° out and 20° in for all angle finishing operations
- Variable position locks, belt head adjusts vertically, horizontally and in between
- Fine thread adjustment for simple and easy belt tracking
- Plain and compound miters are easily obtained by using the standard die cast aluminum miter gauge
- Removable upper guard for contour finishing
- Miter gauge

STOCK NUMBER	414600	414601
Model Number	J-4300A	J-4301A
Belt Size (W x L / in.)	6 x 48	6 x 48
Belt Speed (sfpm)	2,850	2,850
Belt Table Size (in.)	7-3/8 x 14-3/4	7-3/8 x 14-3/4
Belt Table Tilt (deg.)	45° out and 20° in	45° out and 20° in
Platen (L x W / in.)	6-1/4 x 14-3/4	6-1/4 x 14-3/4
Motor (HP)	1-1/2HP, 115/230V, 1Ph, Prewired 115V	1-1/2HP, 230V, 3Ph
Overall Dimensions (L x W x H / in.)	26 x 19 x 58	26 x 19 x 58
Net Weight (lbs.)	215	215



3" x 79" BELT GRINDER



414610

DURABILITY

- Sturdy enclosed base
- Fully assembled for immediate use

SAFETY

- JET exclusive spark arrester to prevent sparks from flying while using the full length of the belt

EASE OF USE

- Pivots up and down on base for easy and safe work height adjustments
- Hinged top cover opens for access to grind large pieces using the entire length of the belt
- Advanced belt tracking with vented front wheel fixed in place for rigidity when grinding on the wheel radius
- Locking handle for top cover
- 3" Round connector and hose clamp for ease of mounting to a metalworking dust collection system
- Supplied with 3 extra 80 grit silicon carbide belts standard

STOCK NUMBER	414610	414615
Model Number	BG-379-1	BG-379-3
Belt Size (W x L / in.)	3 x 79	3 x 79
Belt Speed (sfpm)	6,600	6,600
Contact Wheel Size (W x Dia. / in.)	3 x 8	3 x 8
Full Grinding Plane (W x L / in.)	3 x 21	3 x 21
Motor (HP)	4HP, 220V, 1Ph	4HP, 220V, 3Ph
Net Weight (lbs.)	200	210



2" x 72" SQUARE WHEEL BELT GRINDER



DURABILITY

- Flat & Angular Stock: Platen setting is the perfect angle for high speed, precision flat and level grinding

SAFETY

- Fully guarded cover

EASE OF USE

- Shaping: For grinding, and refinishing cylindrical shapes. Yoke surface conforms to shape of the surface to produce an even, smooth finish
- Roughing: Serrated contact wheel is used for removing heavy stock, cleaning up a weld or snagging a casting
- Contouring: Grind difficult to reach areas with the 3" x 2" or 1-1/2" x 2" diameter contact wheels

STOCK NUMBER	577000
Model Number	J-4103
Belt Size (W x L / in.)	2 x 72
Belt Speed (sfpm)	4,600
Contact Wheel Diameter (in.)	8 x 2; 3 x 2; 1-1/2 x 2
Contact Wheel Durometer	70
Motor (HP)	1HP, 115/230V, 1Ph, Prewired 115V
Overall Dimensions (L x W x H / in.)	17 x 31 x 17
Net Weight (lbs.)	163



BELT TENSIONING
ADJUSTMENTS

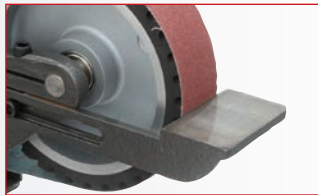

WORK REST



UPPER COVER



USA MADE BALDOR MOTOR



NEW

THREE WHEEL BELT GRINDERS



577100

DURABILITY

- Heavy-duty casted body for years of grinding
- Die casted belt lever
- Vented full motor shroud keeps all dust and chips away from the motor shaft
- Thermal reset keeps the motor from overheating

SAFETY

- CSA/CUS: Following strict guidelines and electrical requirements, these JET Grinders are CSA/CUS certified
- Innovative safety guarding
- New-Innovative dust port sends all sparks to rear of the grinder and away from the operator
- Power switch with safety key prevents accidental start up

EASE OF USE

- New belt tensioning that is innovative and easy to use
- Tool-less setting of the tool rest and platen saves the operator set up time

STOCK NUMBER	577100	577125	577150	577153
Model Number	BGB-142	BGB-248	BGB-260-1	BGB-260-3
Belt Diameter (in.)	1 x 42	2 x 48	2 x 60	2 x 60
Belt Speed (sfpm)	5,500	6,000	8,000	8,000
Contact Wheel Diameter (in.)	4-3/4 x 2	5 x 2	7 x 2	7 x 2
Electrics	3/4HP, 115/230V, 1Ph	1HP, 115/230V, 1Ph	1-1/2HP, 115/230V, 1Ph	3HP, 230/460V, 3Ph
Prewired	115V	115V	115V	230V
Overall Dimensions (D x W x H / in.)	20-17/32 x 18-5/8 x 20-5/16	20-5/8 x 19 x 22-11/32	23-3/32 x 21 x 26-11/16	23-3/32 x 21 x 26-11/16
Net Weight (lbs.)	132	154	189	189
Shipping Weight (lbs.)	145	168	207	207



20" DISC GRINDER



577010

DURABILITY

- Rigid column and heavy-duty base
- Direct drive motor

SAFETY

- Equipped with low voltage protection on/off switch which trips to the off position when the voltage drops below a predetermined safe level
- Wrap-over guard for added safety
- Foot brake for rapid braking

EASE OF USE

- Extra large tilting table lowers completely below disc for use of the entire disc surface
- Tilting table capability adds flexibility of 45° forward and 15° backward on positive lock rack and gear
- Miter gauge
- Enclosed dust port

STOCK NUMBER	577010	577011
Model Number	J-4421-2	J-4421-4
Disc Diameter (in.)	20	20
Disc Speed (rpm)	1,725	1,725
Disc Table Size (L x W / in.)	27-1/2 x 10-1/2	27-1/2 x 10-1/2
Table Slots (in.)	3/8 x 3/4	3/8 x 3/4
Disc Table Tilt (deg.)	45° out, 15° in	45° out, 15° in
Motor (HP)	3HP, 220V, 3Ph	3HP, 460V, 3Ph
Overall Dimensions (L x W x H / in.)	30 x 28 x 53	30 x 28 x 53
Net Weight (lbs.)	400	400



12" INDUSTRIAL DISC FINISHING MACHINE



DURABILITY

- Heavy-duty one-piece steel stand with leveling feet
- Fully machined, balanced disc runs vibration free

EASE OF USE

- Optimum speed of 1,960 RPM, which is ideal for both metal and wood finishing
- Easy to read scale shows exact degree of table tilt
- Plain and compound miters are easily obtained by using the standard die-cast aluminum miter gauge

STOCK NUMBER	414602
Model Number	J-4400A
Disc Diameter (in.)	12
Disc Speed (rpm)	1,960
Disc Table Size (L x W / in.)	12 x 16-3/8
Table Slots (in.)	3/8 x 3/4
Disc Table Tilt (deg.)	45° out and 20° in
Motor (HP)	1-1/2HP, 115/230V, 1Ph, Prewired 115V
Overall Dimensions (L x W x H / in.)	29 x 17 x 42-3/4
Net Weight (lbs.)	164



NEW

INDUSTRIAL VARIABLE SPEED GRINDER



DURABILITY

- Cast iron guards house the 36 and 60 grit wheels
- Adjustable cast iron tool rests
- Massive cast iron body
- Totally enclosed pre-lubricated ball bearings
- Wheel dresser

SAFETY

- CSA/US: Following strict guidelines and electrical requirements, this JET Industrial Variable Speed Grinder is CSA/US certified
- Brake resistor added for rapid wheel stoppage
- Large eye safety shields
- Rubber mounts prevent movement

EASE OF USE

- Variable speed provides wide range of RPM's
- Single dust chute hose
- Two 2-1/2" round dust ports with single outlet collection hose

STOCK NUMBER	578208
Model Number	IBG-8VS
Shaft Diameter (in.)	5/8
Wheel Diameter (dia. x W / in.)	8 x 1 X 5/8
Wheel Speed (rpm)	900 - 3600
Wheel Grits	36 / 60
Motor (HP)	100 - 240 , Single Phase, Pre-wired 115V
Overall Dimensions (L x W x H / in.)	21.1 x 13.8 x 13.9
Net Weight (lbs.)	66



NEW

INDUSTRIAL VARIABLE SPEED BUFFER



DURABILITY

- Massive cast iron body
- Totally enclosed pre-lubricated ball bearings

SAFETY

- CSA/US: Following strict guidelines and electrical requirements, this JET Industrial Buffer is CSA/US certified
- Brake resistor added for rapid wheel stoppage
- Rubber mounts prevent movement

EASE OF USE

- Variable speed provides wide range of RPM's

STOCK NUMBER	578218
Model Number	IBG-8VSB
Shaft Diameter (in.)	5/8
Buffing Wheel Diameter (dia. x W /in.)	8 x 1/2
Wheel Speed (rpm)	900 - 3600
Buffing Wheel Type	Spiral/Half Spiral
Motor (HP)	1 HP, 115/230V , Single Phase, Pre-Wired 115V
Overall Dimensions (L x W x H / in.)	23-1/2 x 8 x 10-9/16
Net Weight (lbs.)	40



INDUSTRIAL BENCH GRINDERS



578008

DURABILITY

- Heavy-duty capacitor motor
- Sealed bearings for years of maintenance free grinding
- Industrial strength construction for years of demanding use
- Fine and coarse vitrified grinding wheels

SAFETY

- CSA/CUS: Following strict guidelines and electrical requirements, these JET Industrial Bench Grinders are CSA/CUS certified
- Innovative safety guarding
- Safety switches on 8" & 10"
- Low voltage protection on 12"
- OSHA compliant
- Adjustable safety shields

EASE OF USE

- Pre-drilled bases for mounting on stand, work benches or dust collection stands
- Adjustable tool rests
- Single dust chute hose
- Wheel dresser

STOCK NUMBER	578008	578010	578012
Model Number	IBG-8	IBG-10	IBG-12
Shaft Diameter (in.)	5/8	1	1-1/4
Wheel Diameter (Dia. x W / in.)	8 x 1	10 x 1	12 x 2
Wheel Speed (rpm)	3,450	1,720	1,720
Wheel Grits	36 / 60	36 / 60	36 / 60
Motor (HP)	1 HP, 115V, 1Ph	1-1/2 HP, 115V, 1Ph	2 HP, 230V, 1 Ph.
Overall Dimensions (L x W x H / in.)	21 x 14 x 14	24 x 17 x 16	27 x 18 x 18
Weight (lbs.)	64	113	176



INDUSTRIAL BENCH GRINDER ACCESSORIES

INDUSTRIAL BENCH GRINDER STANDS

- Heavy-duty cast iron construction
- Wide stance base gives stable workstation
- Heavy gauge metal (578173)
- LED lamp for bright light with low heat output for safety
- Extra large water pot
- 33" High

STOCK NUMBER	578172	578173
Model Number	IGB-Stand	DBG-Stand
Fits Grinders (in.)	8 & 10	10 & 12
Overall Dimensions (L x W x H / in.)	21-1/2 x 10-3/4 x 33	20 x 17 x 33
Net Weight (lbs.)	69	108



578172



578173

LED INDUSTRIAL BENCH GRINDER LAMP

- Attached to plate or mounting holes on grinder - 20" in length
- Fits 8, 10 & 12" Industrial Grinders

STOCK NUMBER	578100
Model Number	DGB-Lamp
Fits Grinders (in.)	8 & 10 & 12



SHOP BENCH GRINDERS



577102

DURABILITY

- Rubber mounts prevent movement
- Cast iron wheel guards and dust vents
- Fine and coarse vitrified grinding wheels included

SAFETY

- UL listed
- One-piece quick adjusting spark guards
- Large eye shields with quick adjustment

EASE OF USE

- Totally enclosed pre-lubricated ball bearings
- Heavy-duty guarded toggle switch on 8" and 10"
- Adjustable tool rests

STOCK NUMBER	577101	577102	577103
Model Number	JBG-6A	JBG-8A	JBG-10A
Shaft Diameter (in.)	1/2	5/8	1
Wheel Diameter (Dia. x W / in.)	6 x 3/4	8 x 1	10 x 1
Wheel Speed (rpm)	3,450	3,450	1,725
Wheel Grits	36/60	36/60	24/46
Motor (HP)	1/2HP, 115V, 1Ph	1HP, 115V, 1Ph	1-1/2HP, 115V, 1Ph
Overall Dimensions (L x W x H / in.)	18 x 10-1/2 x 8-1/2	19 x 12-1/2 x 10	24-1/2 x 12-1/4 x 13
Net Weight (lbs.)	38	60	110



PEDESTAL STAND FOR SHOP BENCH GRINDERS

DURABILITY

- Heavy-duty cast iron construction provides strength and durability

SAFETY

- Wide stance base gives you a stable grinder workstation

EASE OF USE

- Coolant tank and tool tray are on an adjustable platform for your convenience
- Compatible with all JET Bench Grinders



STOCK NUMBER	577172
Model Number	JPS-2A
Mounting Surface (L x W / in.)	11 x 10
Overall Dimensions (L x W x H / in.)	31 x 21 x 5
Net Weight (lbs.)	52



METAL DUST COLLECTOR



DURABILITY

- Quiet, effective dust collection method

SAFETY

- Non-sparking aluminum housing and fan blade
- Easy to empty clean-out drawer
- Easy to change air filter
- CSA/US: Following strict guidelines and electrical requirements, this JET Dust Collector is CSA/US certified

EASE OF USE

- Chips and dust collect into a metal drawer that is easy to clean
- Portable on 4 casters and 2 handles for ease of movement
- 3" to 2" Hose adapter include

STOCK NUMBER	414700
Model Number	JDC-501
Maximum CFM	490
Maximum Hose Velocity (sfpm)	5610
Filter (W x L x D / in.)	19 x 9-1/2 x 1-3/4
Filter Efficiency:	99% @5micron
DBA @ 5'	75
Hose Size (in.)	3 (2) with adapter
Motor (HP)	1-1/2HP, 115V, Single Phase
Net Weight (lbs.)	157
Overall Dimensions (L x W x H / in.) with wheels	30-5/8 x 20-7/8 x 29

OPTIONAL EQUIPMENT	STOCK NUMBER
3" Heat Resistance Hose to 130 Degrees	414720
3" Heat Resistance Hose to 180 Degrees	414725
2" Heat Resistance Hose to 130 Degrees	414730
2" Heat Resistance Hose to 180 Degrees	414735
Pair of Replacement Filters	414705



METAL DUST COLLECTOR STAND



DURABILITY

- Non-sparking aluminum fan blade and housing eliminates the risk of fire during the collection of abrasive dust and chips
- Turbo fan design provides a maximum of 472 CFM of air movement for effective metal dust collection
- 16 gauge steel construction

SAFETY

- CSA/US: Following strict guidelines and electrical requirements, this JET Dust Collector is CSA/US certified
- Oversized on/off switch with magnetic safety key prevents accidental start-ups

EASE OF USE

- Two 115V outlets on side of unit for lamps
- Chips and dust collect into a metal drawer that is easy to empty, along with the high temperature filters that are easily replaceable
- Bench top belt, disc or combination machines can be mounted using the optional Universal Adapter Plate (414830)
- Two removable water pots gives you the features of a pedestal stand along with all the benefits of a dust collector
- Four adjustable leveling pads
- Easy to change filter
- 3" end cap

STOCK NUMBER	414800
Model Number	JDCS-505
Style (Type)	Stand
Filter Efficiency	90% @ 50 Microns
Sound Rating (db.)	75 db. @ 10 Ft
Static Pressure (wc.)	748
Filter Size (W x L x D / in.)	6-3/4 x 2-5/8 x 13-1/2
Maximum CFM	472
Maximum Hose Velocity (sfpm)	3,465
Max. Static Pressure (wc.)	2440
Port Size	2 Inlets @ 3"
Plug Requirements	20P, 125V/20A
Motor (HP)	1/2Hp, 115V, 60 Hz
Overall Dimensions (L x W x H / in.)	15-1/2 x 16 x 32-1/4
Weight (lbs.)	92.4

OPTIONAL EQUIPMENT	STOCK NUMBER
2', 3" Heat Resistance Up to 180°Hose	414813
2', 2" Heat Resistance Up to 180°Hose	414812
3" to 1-1/2" Reducer	414815
3" to 2" Reducer	414820
3" to 2-1/2" Reducer	414825
Universal Adapter Plate	414830
Replacement Filter for JDCS-505	414840



GRINDING/FINISHING HELPFUL INFO

Every JET machine is designed with the sole intent of making your job easier. Here is some basic and helpful information on all our finishing machines to enhance the user experience.

GRINDING/FINISHING MACHINES APPLICATIONS

Belt grinding is a versatile process suitable for all kinds of different applications. There are three different applications of the belt grinding technology:

- 1 Finishing: surface roughness, removal of micro burrs, cosmetic finishes, polishing
- 2 Deburring: radiusing, burr removal, edge breaking
- 3 Stock removal: high stock removal, cleaning (e.g. of corrosion), eliminating mill or tool marks, dimensioning

CHANGING VARIABLES

There are several objectives possible for grinding with coated abrasives. Among them are the right application (e.g. finish or stock removal), time saving and efficiency of the abrasive tool. To achieve the above objectives, it is essential to look in more detail to the variables, which affect them. These include the work material properties, the grit and abrasive type of the grinding belt, belt speed, belt sequences, contact wheel hardness and diameter, serration, type of lubricant (or dry) and grinding pressure. Changing these variables will affect the performances of the belt grinding process.

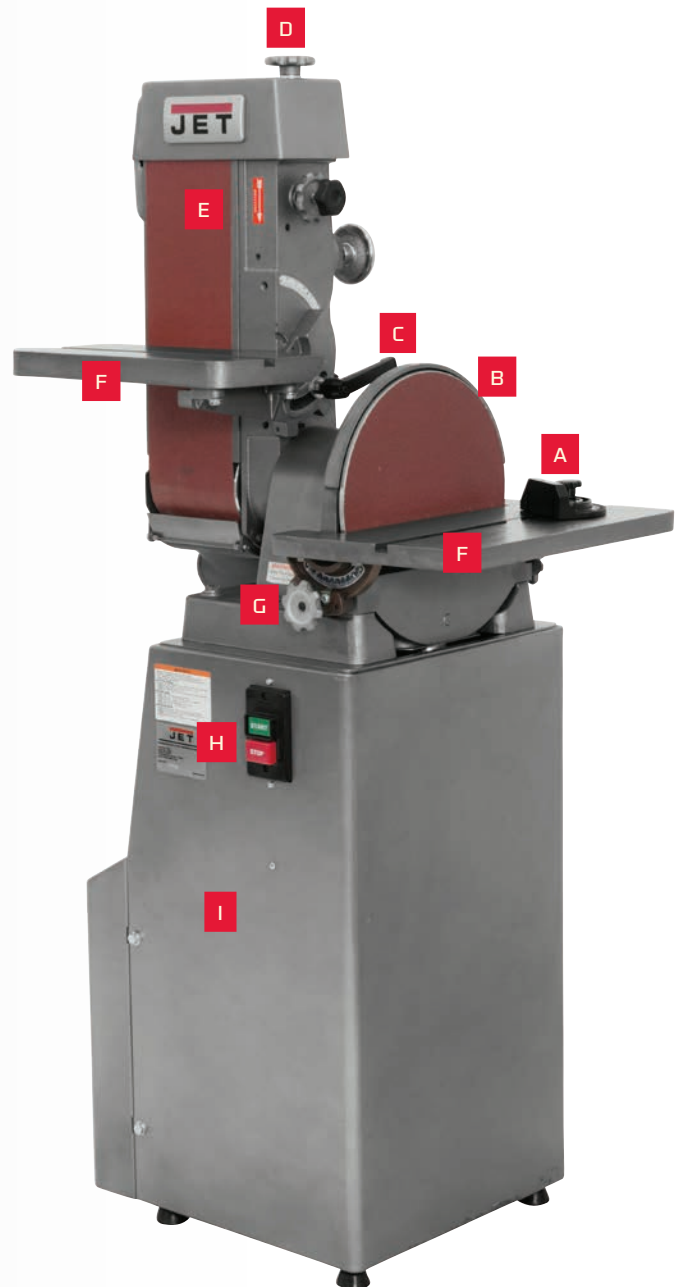

COMMON GRINDING/FINISHING TERMINOLOGY

- | | |
|---------------------------|------------------------------------|
| A MITER GAUGE | F ABRASIVE BELT |
| B ABRASIVE DISC | G CAST IRON TILTING TABLES |
| C VARIABLE POSITION LOCKS | H TABLE LOCKING KNOB |
| D BELT ADJUSTMENT KNOB | I ON/OFF SWITCH |
| E TOP COVER LOCK KNOB | J HEAVY-DUTY ONE PIECE METAL STAND |

TYPES OF GRINDING/FINISHING MACHINES

Jet offers over 28 different finishing machines in different sizes, styles and many different voltages, but they easily break down to 4 different types. Refer to category summary below.







FORMING

Machine professionals who demand precision, accuracy and reliability from the equipment in their shop look to JET Metal forming equipment when adding to or upgrading their operation. High-quality JET brakes, shears, rolls, english wheel, planishing hammer, presses and notchers allow you to expand your operation and offer customers more. Professional manuals ensure quick start up and efficient operation, and JET backs all its machines with an industry-leading two-year warranty.

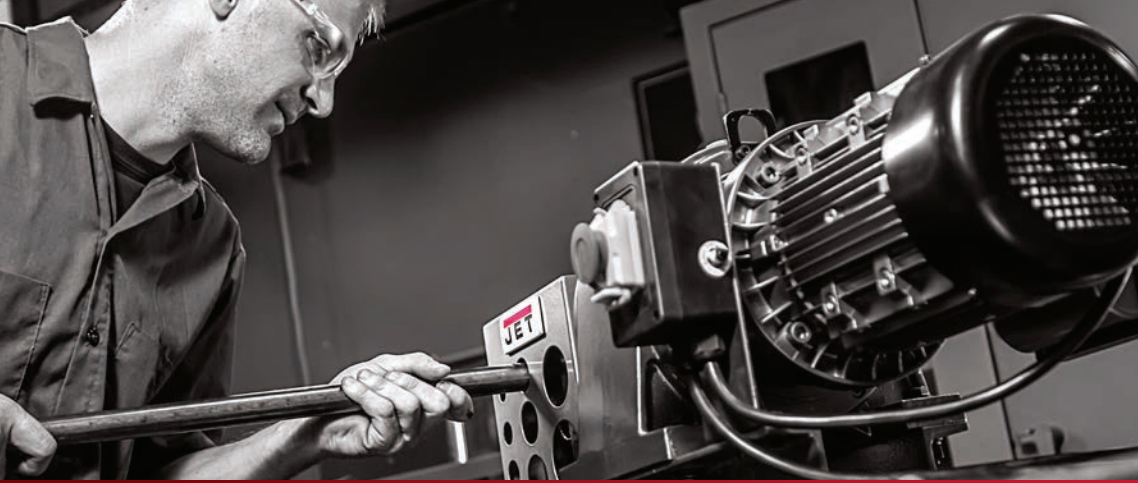

CHOOSE YOUR FORMING EQUIPMENT QUICK REFERENCE GUIDE

STOCK NUMBER	MODEL NUMBER	DESCRIPTION	MACHINE TYPE	MAX CAPACITY MILD STEEL (GAUGE)	MAX CAPACITY LENGTH (IN.)	MOTOR (HP)	PAGE NUMBER	
SHEARS								
756205	HS1452-1T,	52" x 14 Gauge Hydraulic Shear	Shear	14	52	3HP, 230V, 1Ph	154	
756206	HS1452-3T,	52" x 14 Gauge Hydraulic Shear	Shear	14	52	3HP, 220V, 3Ph	154	
756203	PS-1652T	52" x 16 Gauge Pneumatic Shear	Shear	16	52	Pneumatic	155	
756202	FS-1652J,	52" x 16 Gauge Foot Shear	Shea	16	52	Manual	156	
COMBINATION SHEAR, BRAKE & ROLL								
756041	SBR-40M,	40" 3 In 1 Shear, Brake and Roll	Shear, Brake, Roll	20	40	Manual	157	
756031	SBR-30M,	30" 3 In 1 Shear, Brake and Roll	Shear, Brake, Roll	20	30	Manual	157	
FLOOR BOX & PAN BRAKES								
752125	BPF-1240	40" x 12 Gauge Box & Pan Brake with Foot Clamp	Box & Pan Brake	12	40	Manual	159	
752127	BPF-1450	50" x 14 Gauge Box & Pan Brake with Foot Clamp	Box & Pan Brake	14	50	Manual	159	
NEW	754125	BP-1272	72" x 12 Gauge Floor Box & Pan Brake	Box & Pan Brake	12	72	Manual	161
NEW	754130	BP-1672	72" x 16 Gauge Floor Box & Pan Brake	Box & Pan Brake	16	72	Manual	161
NEW	752130	PBF-1650D	50" x 16 Gauge Dual Sided Box & Pan with Foot Clamp	Box & Pan Brake	16	50	Manual	158
754110	BPF-1248	48" x 12 Gauge Floor Model Box & Pan Brake	Box & Pan Brake	12	48	Manual	160	
754115	BPF-16100	100" x 16 Gauge Floor Model Hand Brake	Box & Pan Brake	16	100	Manual	160	
754105	BPB-1650	50" x 16 Gauge Bench Model Box & Pan Brake	Box & Pan Brake			Manual	162	
ELECTRIC PLATE ROLL								
NEW	756030	EPR-1460-3	60" x 14 Gauge Electric Plate Roll 3Ph	Plate Roll	14	60	2HP, 230/460V, 3-Phase	163

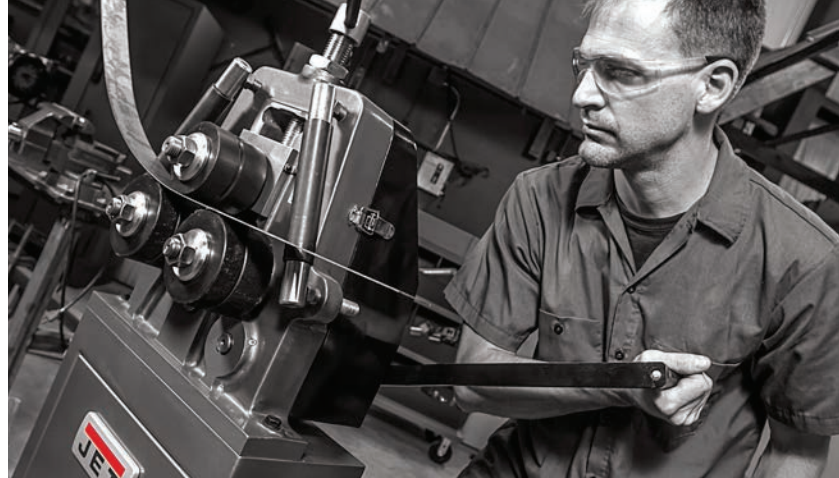
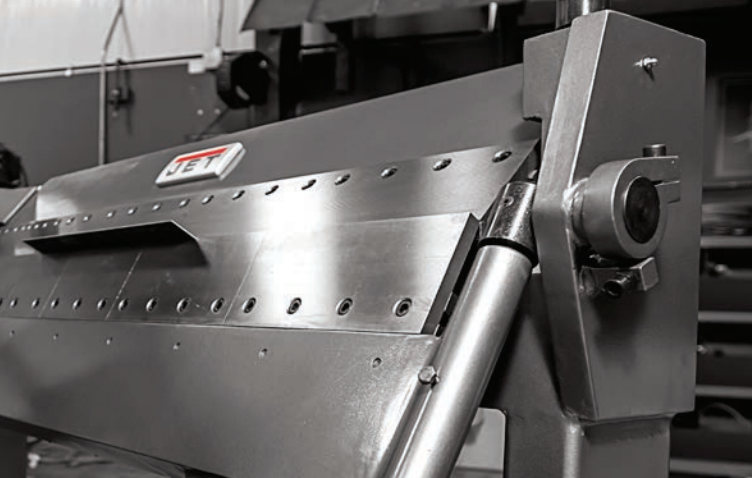

STOCK NUMBER	MODEL NUMBER	DESCRIPTION	MACHINE TYPE	MAX CAPACITY MILD STEEL (GAUGE)	MAX CAPACITY LENGTH (IN.)	MOTOR (HP)	PAGE NUMBER	
SLIP ROLL								
756027	ESR-1650-1T	50" x 16 Gauge Electric Slip Roll 1Ph	Slip Roll	16	50	1-1/2HP, 115/230V, 1PhPrewired230V	164	
756028	ESR-1650-3T	50" x 16 Gauge Electric Slip Roll 3Ph	Slip Roll	16	50	1-1/2HP, 230V, 3Ph	164	
756020	SR-2024M	24" x 20 Gauge Bench Model Slip Roll	Slip Roll	20	24	Manual	165	
756026	SR-2236M	36" x 22 Gauge Bench Model Slip Roll	Slip Roll	22	36	Manual	165	
756050	SR-1650M	50" x 16 Gauge Bench Model Slip Roll	Slip Roll	16	50	Manual	165	
ROLL BENDERS								
NEW	754430K	MPR-10HV	Manual Roll Bender	Roll Bender		NA	168	
NEW	754435	EPR-2	Electric Roll Bender	Roll Bender		1HP, 230V, 3-Phase	167	
LOCK FORMER								
NEW	756090	LF-20	20 Gauge Pittsburgh Type Lockformer	Lock Former	20	-	1-1/2HP, 115V, Single Phase	170
NOTCHER								
NEW	754410	EMN-9	Hydraulic Sheet Metal Notcher	Hydraulic Notcher	9	7-3/4 x 7-3/4	3HP, 220V, 3-Phase	172
NEW	754405	PMN-11	Pneumatic Sheet Metal Notcher	Pneumatic Notcher	11	5 x 5	Pneumatic	173
NEW	754420	ESN-40	Electric Sch40 Pipe Notcher	Electric Pipe/Tube Notcher			2 HP, 220V, Single Phase	171
	756016	HN-16T	Bench Hand Notcher	Notcher	16	6	Manual	176
NEW	756180	TPGN4-1	Dual Station Abrasive Notcher	Abrasive Notcher			2 HP, 220V, 1Ph	174
NEW	756185	TPGN4-3	Dual Station Abrasive Notcher	Abrasive Notcher			4 HP, 230/460V, 3PH	174
NEW	755017	FN-16	16 Gauge Corner Notcher	Notcher	16			175
ENGLISH WHEEL								
	756151	WH-45T	45" English Wheel	English Wheel	16	45	Manual	177
PLANISHING HAMMER								
	756121	PH-24T	24" Planishing Hammer	Planishing Hammer	16	24	Pneumatic	178
MANUAL SHRINKER/STRETCHER								
NEW	756018	MSS-1	Manual Shrinker/Stretcher	Shrinker/Stretcher	16	6	Manual	179

52" HYDRAULIC SHEAR



756206

DURABILITY

- Heavy-duty steel construction eliminates deflection across the blade span
- Hand-wheel controlled back gauge for quick and easy depth adjustments

SAFETY

- Easy-to-use foot control with e-stop right in the operators reach

EASE OF USE

- Precise bed and beam accuracy assures working accuracy
- Low cutting angle to cut narrow strips without twisting
- 14 gauge maximum capacity for cutting mild steel
- 10 – 12 gauge maximum capacity for soft alloys

STOCK NUMBER	756205	756206
Model Number	HS1452-1T	HS1452-3T
Max. Soft Alloy Capacity (ga.)	10 - 12	10 - 12
Mild Steel Capacity (ga.)	14	14
Shearing Length Capacity (in.)	52	52
Back Stop Capacity (in.)	25-1/2	25-1/2
Front Stop Capacity	23-1/2"	23-1/2"
Strokes per Minute (full length)	20	20
Motor (HP)	3HP, 220V, 1Ph	3HP, 220V, 3Ph
Overall Dimensions (L x W x H / in.)	62 x 77 x 42	62 x 77 x 42
Net Weight (lbs.)	1,335	1,335



52" PNEUMATIC SHEAR



DURABILITY

- High-quality cast-iron grade frame to eliminate deflection across the blade-span and blade framework
- Precise bed and beam alignment assures working accuracy

SAFETY

- Low cutting angle to cut narrow strips without twisting
- Easy-to-use foot control with e-stop right in the operators reach

EASE OF USE

- Adjustable working bed for correct set up according to the blade clearance
- 16 gauge maximum cutting capacity for mild-steel
- 12-14 gauge maximum cutting capacity for aluminum and copper alloys
- Pneumatic controls now makes shearing a one man job

STOCK NUMBER	756203
Model Number	PS-1652T
Max. Soft Alloy Capacity (ga.)	12 - 14
Mild Steel Capacity (ga.)	16
Shearing Length Capacity (in.)	52
Back Stop Capacity (in.)	29-1/2
Front Stop Capacity (in.)	35-1/4
Strokes per Minute (full length)	40
Air Consumption per Stroke (cfm)	1.3
Air Consumption (cfm)	25.3
Overall Dimensions (L x W x H / in.)	60 x 24 x 43
Net Weight (lbs.)	1312



52" FOOT SHEAR

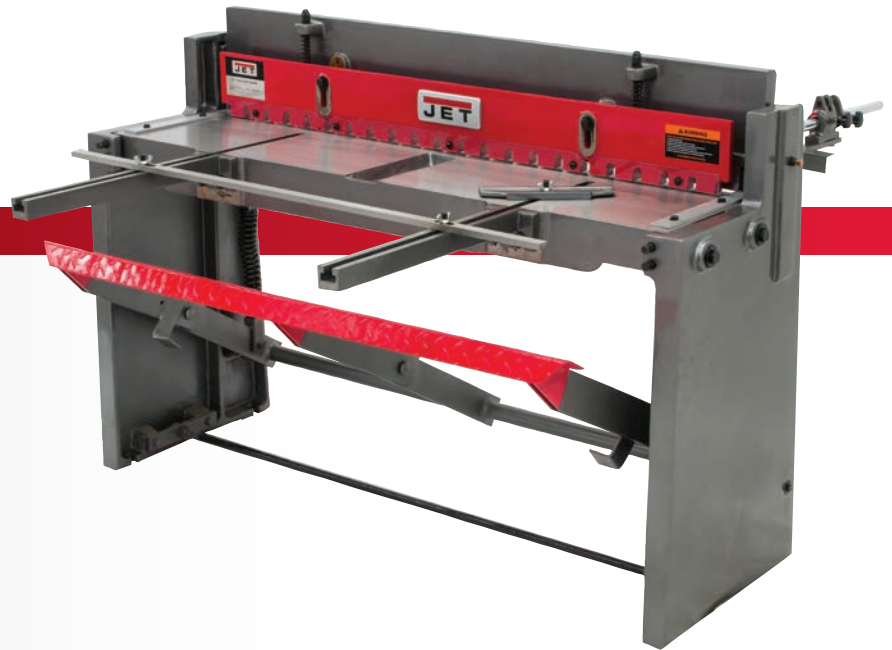

DURABILITY

- Two-way blade configuration provides twice the cutting life
- Upper blade is two-way; bottom blade is one-way
- 2° angle cutting edge; 1° face relief

SAFETY

- Blade guard

EASE OF USE

- Scale guides marked for precise cutting.
- Capable of shearing sheet steel, bars plus many non-metallic materials
- Ideal for precision shearing of mild steel up to 16 gauge

STOCK NUMBER	756202
Model Number	FS-1652J
Mild Steel Capacity (ga.)	16
Max. Soft Alloy Capacity (ga.)	14
Shearing Length Capacity (in.)	52
Back Gauge Capacity (in.)	25-1/2
Front Gauge Capacity (in.)	28
Overall Dimensions (L x W x H / in.)	62-1/4 x 72 x 41-1/2
Net Weight (lbs.)	1220



COMBINATION SHEAR, BRAKE AND ROLL



756031

DURABILITY

- Cast iron frame and cast iron table
- Dual edge shear blade

EASE OF USE

- Brake is equipped with easily removable fingers that permit angle, channel, box and other complex bending operations
- Slip rolls are precision turned and ground with wire grooves
- Combination shear, brake and roll in one compact machine
- Spring-loaded work hold down
- Back gauge
- Right or left hand operation
- Shear can be used for mild steel, aluminum, brass, copper, lead, plastic and zinc

STANDARD EQUIPMENT

- Set of male dies
- One set of female dies

STOCK NUMBER	756031	756041
Model Number	SBR-30M	SBR-40M
Mild Steel Capacity (ga.)	20	20
Shearing Capacity (ga.)	20	20
Bending Capacity (ga.)	20	20
Rolling Capacity (ga.)	20	20
Size of Slip Roll (LxDia./in.)	30 x 1-1/2	40 x 1-5/8
Width of Upper Dies (in.)	1, 2, 3, 6, 8, 10	1, 1-1/2, 2, 2-1/2, 4, 7, 10, 12
Upper Die Height (in.)	4-11/16	4
Min. Forming Radius (in.)	3/4	1
Wire Grooves (in.)	1/8, 3/16, 9/32	3/16, 9/32, 3/8
Base Dimensions (L x W x H / in.)	14-1/2 x 32-3/8	16-1/2 x 43
Overall Dimensions (L x W x H / in.)	40 x 16 x 24	56 x 23 x 30
Net Weight (lbs.)	286	506

OPTIONAL EQUIPMENT	STOCK NUMBER
Floor Stand for SBR-30M	754030
Floor stand for SBR-40M	754040



NEW

DUAL SIDED BOX AND PAN BRAKE WITH FOOT CLAMP



DURABILITY

- All body sections are welded steel plate with heavy truss rods and braces designed to give greater strength and durability
- Hardened and ground fingers

SAFETY

- Rubber stops on rear of lower arm to prevent contact with support frame
- Non-skid foot pedal

EASE OF USE

- Set lower beam parallelism more accurately with graduated scale on each side
- Wide assortment of finger widths allow greater versatility in the shop
- Removable upper fingers and on the apron for greater versatility in making custom bends
- Repeat bends are easy with a quick turn of the stop collar on the stop rod
- Hydraulic spring to assist in raising the apron reduces strain on the operator
- Large easy to use foot clamp allows the operator hands free clamping
- Toolless angle stop allows for the operator to easily set the stop to their predetermined length

STOCK NUMBER	752130
Model Number	PBF-1650D
Mild Steel Capacity (ga.)	16
Bending Length Capacity (in.)	50
Maximum Degree of Bend	135°
Maximum Clamping Bar Lift (foot operated) (in.)	1.81
Maximum Box Depth (in.)	2-1/2
Number and Width of Fingers (in.)	1@ 1, 1-1/8, 1-3/8, 1-1/2, 1-3/4, 2, 3, 4, 6, 7-3/4, 10, 10-5/8
Finger Nose Angle (deg.)	45°
Nose Radius (in.)	1/32
Overall Dimensions (L x W x H / in.)	67-3/8 x 28 x 51-1/2
Net Weight (lbs.)	772
Gross Weight (lbs.)	849



FLOOR BOX AND PAN BRAKES WITH FOOT CLAMP



752125

DURABILITY

- All body sections are welded steel plate with heavy truss rods and braces designed to give greater strength and durability

SAFETY

- Material clamping is foot operated to save strain on back and arms
- Hydraulic spring to assist in raising the clamping handle

EASE OF USE

- Wide assortment of finger widths allow greater versatility in the shop
- Stop rod for repeatable bending
- Conveniently located electrical box allows easy access and quick repairs if ever needed

STOCK NUMBER	752125	752127
Model Number	PBF-1240	PBF-1450
Mild Steel Capacity (ga.)	12	14
Bending Length Capacity (in.)	40	50
Max. Clamping Bar Lift (foot operated) (in.)	1-7/8	1-7/8
Maximum Box Depth (in.)	2-1/2	2-1/2
1Finger @ Width (in.)	1, 1-1/8, 1-3/8, 1-1/2, 1-3/4, 2, 3, 4, 6, 7-3/4, 10-5/8	1, 1-1/8, 1-3/8, 1-1/2, 1-3/4, 2, 3, 4, 6, 7-3/4, 10, 10-5/8
Finger Nose Angle (degree)	42	42
Nose Radius (in.)	1/32	1/32
Overall Dimensions (L x W x H / in.)	58 x 25 x 50	67 x 28 x 50
Net Weight (lbs.)	705	900



FLOOR MODEL BOX AND PAN BRAKES



754110

DURABILITY

- All body sections are welded steel plate with heavy truss rods and braces designed to give greater strength and durability
- Both the bed and apron are bored in line to assure the utmost accuracy

EASE OF USE

- Wide assortment of finger widths allow greater versatility in the shop
- Counter weights can be moved up or down to provide more or less leverage
- To make repeat bends are easy with a quick turn of the stop collar on the stop rod

STOCK NUMBER	754110	754115
Model Number	BP-1248	BPF-16100
Mild Steel Capacity (ga.)	12	16
Bending Length Capacity (in.)	48	100
Maximum Lift of Beam (in.)	1-1/2	2-1/4
Maximum Box Depth (in.)	4	4
Beam Adjustment (in. / front to rear)	7/8	1
Number and Width of Fingers (in.)	5@3, 2@4, 5@5	4@12, 4@6, 3@5, 1@4, 1@3-1/2, 1@3, 1@2-1/2
Finger Nose Angle (deg.)	45	45
Nose Radius (in.)	1/32	1/32
Overall Dimensions (L x W x H / in.)	81.5 x 29 x 69	140 x 30 x 76
Net Weight (lbs.)	1100	2450



NEW

72" BOX AND PAN BRAKES



754125

DURABILITY

- All body sections are welded steel plate with heavy truss rods and braces designed to give greater strength and durability
- Both the bed and apron are bored in line to assure the utmost accuracy

SAFETY

- Soft grips on top of counter weight bar to prevent damaging the operator's hands

EASE OF USE

- Soft touch handle grips
- With all fingers installed it can be used as a full-length nose bar, turning the machine into a straight bending brake
- Wide assortment of finger widths allows greater versatility in the shop
- Repeat bends are easy with a quick turn of the stop collar on the stop rod
- Counter weights can be moved up or down to provide leverage
- Toolless Angle Stop allows for the operator to easily set the stop to their predetermined length

STOCK NUMBER	754125	754130
Model Number	BP-1272	BP-1672
Mild Steel Capacity (ga.)	12	16
Bending Length Capacity (in.)	72	72
Maximum Degree of Bend	135°	135°
Maximum Lift of Beam (in.)	2.2	2.2
Maximum Box Depth (in.)	4	4
Beam Adjustment (in. / front to rear)	2	2
Number and Width of Fingers (in.)	6@3, 3@4, 6@5, 2@6	6@3, 3@4, 6@5, 2@6
Finger Nose Angle (deg.)	45	45
Nose Radius (in.)	1/32	1/32
Overall Dimensions (L x W x H / in.)	100 x 30 x 41	100 x 30 x 41
Net Weight (lbs.)	2182	1960
Gross Weight (lbs.)	2535	2290



BENCH MODEL BOX AND PAN BRAKE



DURABILITY

- Incorporates all the features of our standard brakes but with greater range of applications

EASE OF USE

- With fingers installed it can be used as a full-length nose bar, turning the machine into a straight bending brake
- 16 assorted sized sectioned fingers are easily removed for box bending and special forming operations

STOCK NUMBER	754105
Model Number	BPB-1650
Mild Steel Capacity (ga.)	16
Bending Length Capacity (in.)	50
Maximum Lift of Beam (in.)	1-1/4
Maximum Box Depth (in.)	4
Beam Adjustment (in. / front to rear)	5/8
Number and Width of Fingers (in.)	4@2, 6@3, 6@4
Finger Nose Angle (deg.)	45
Nose Radius (in.)	1/32
Overall Dimensions (L x W x H / in.)	66x 23-1/4 x 32-1/4
Net Weight (lbs.)	448



NEW

14G x 60" ELECTRIC PLATE ROLLER

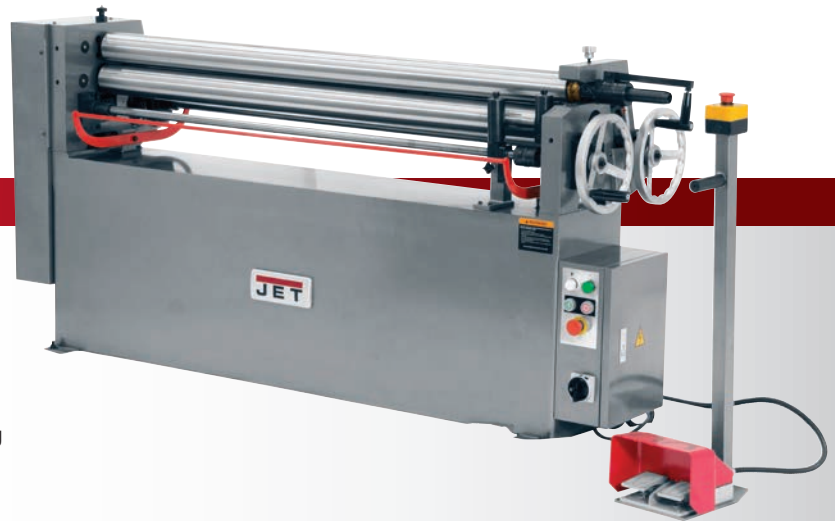

DURABILITY

- Three-roll design with two drive rolls
- Rolls are made of hardened polished high carbon steel
- Heavy-duty frame and base insure precise sheet metal rolling

SAFETY

- CSA/US: Following strict guidelines and electrical requirements, this JET Plate Roller is CSA/US certified
- Foot-control assembly with emergency-stop
- Integrated safety bar system along entire bending length permits quick stoppage of machine

EASE OF USE

- Forming roll has attached position scale for equal pressure adjustment
- Weight and rigidity; scale and precision; strength and simplicity define exceptional comfort and ease of operation
- Easy-to-use forward and reverse foot pedal
- Conical attachments for ease of rolling cones, tapers and conicals
- Conveniently located electrical box allows easy access and quick repairs if ever needed

STOCK NUMBER	756030
Model Number	EPR-1460-3
Mild Steel Capacity (ga.)	14
Maximum Forming Length (in.)	60
Number and Diameter of Rolls (in.)	3 @ 3-1/2
Minimum Forming Radius (in.)	5-1/4
Wire Grooves (in.)	3/8, 1/2 & 5/8
Motor (HP)	2HP, 230/460V, 3-Phase
Prewired	230V
Overall Dimensions (L x W x H / in.)	87-1/2 x 31-1/2 x 48
Net Weight (lbs.)	1345
Gross Weight (lbs.)	1543



50" ELECTRICAL POWER SLIP ROLL



756027

DURABILITY

- Rolls are made of hardened polished high-carbon steel
- Three-roll machine with two driven rolls.
- Heavy-duty frame and base insure precise sheet metal rolling

SAFETY

- Convenient foot-control assembly with emergency-button
- Easy-to-use forward and reverse foot pedal with e-stop
- Safety bar, when pushed will shut down the machine

EASE OF USE

- Valuable machine tool for sheet metal forming in HVAC and FAB shops
- Easy setup and operation
- Forming roll has attached position scale for equal pressure adjustment
- Weight and rigidity; scale and precision; strength and simplicity define exceptional comfort and ease of operation
- All electrical and rotating parts are designed for safety and comfortable operation during machine use

STOCK NUMBER	756027	756028
Model Number	ESR-1650-1T	ESR-1650-3T
Mild Steel Capacity (ga.)	16	16
Maximum Forming Length (in.)	50	50
Number and Diameter of Rolls (in.)	3, 3	3, 3
Minimum Forming Radius (in.)	2	2
Wire Grooves (in.)	5/16, 3/8, 1/2	5/16, 3/8, 1/2
Motor (HP)	1-1/2HP, 115/230V, 1Ph Prewired 230V	1-1/2HP, 230V, 3Ph
Overall Dimensions (L x W x H / in.)	71 x 24 x 43	71 x 24 x 43
Net Weight (lbs.)	750	750
Shipping Weight (lbs.)	877	877



BENCH SLIP ROLLS



756020

DURABILITY

- Precision turned carbon steel rolls that are ground and polished

SAFETY

- Large roll adjusting screws facilitate lifting

EASE OF USE

- Suitable for many industrial, educational and vocational shop uses
- Upper roll for easy material removal
- Wire grooves for bending solid rod

STOCK NUMBER	756020	756026	756050
Model Number	SR-2024M	SR-2236M	SR-1650M
Mild Steel Capacity (gauge/in.)	20	22	16
Max. Forming Length (in.)	24	36	50
Number and Diameter of Rolls (in.)	3 and 2	3 and 2	3 and 3
Min. Forming Radius (in.)	1	1	2
Wire Grooves (in.)	3/16, 1/4, 5/16	3/16, 1/4, 5/16	1/4, 5/16, 3/8
Overall Dimensions (L x W x H / in.)	50 x 14 x 14	62 x 14 x 14	68 x 22 x 24
Net Weight (lbs.)	172	212	565



FLOOR STANDS FOR BENCH MODEL METALFORMING MACHINES

- We offer stands that fit our bench model hand brakes, box & pan brakes, slip rolls and combination shear, brake and rolls



754024



754036

STOCK NUMBER	754200	754024	754030	754036	754040	754051
Model Number	S-48N	SRS-24N	SRS-30N	SRS-36N	SRS-40N	SRS-50N
Fits	BP-2248H BP-1648H HB-2248H HB-1648H	SR-2024M	SBR-30M	SR-2236M	SBR-40M	SR-1650M
Overall Dimensions (L x W x H / in.)	56-1/2 x 18-1/4 x 28	30 x 14 x 28	40 x 16 x 24	42 x 14 x 28	49 x 21 x 30	68 x 22 x 30
Net Weight (lbs.)	85	35	45	51	82	70



NEW

ELECTRIC ROLL BENDER

DURABILITY

- Heavy-duty cast iron construction machined to strict tolerances with maintain tolerances and accuracy
- Hardened rolling shafts with bronze bushings ensures the machine will last for years of operation

SAFETY

- CSA/US: Following strict guidelines and electrical requirements, this JET Roller is CSA/US certified
- Foot-control assembly with emergency-stop

EASE OF USE

- Open face design allows the operator to roll full circles
- Reduction gearbox cuts down on operator fatigue
- Equipped with 6 various size segment rolls for flat bar, square tubing and angle iron
- Base comes standard with a full storage cabinet



STOCK NUMBER	754435
Model Number	EPR-2
Type	3 Roll Pyramid Style
Operating Positions	Vertical or Horizontal
PIPE CAPACITY (in. / SCHEDULE 40)	
Size	1
Minimum Diameter	0.28
ROUND TUBE CAPACITY (in.)	
Size	1-1/4
Minimum Diameter	31-1/2
SQUARE TUBE CAPACITY (in.)	
Size	1-1/4
Minimum Diameter	35
SOLID ROUND CAPACITY (in.)	
Size	7/8
Minimum Diameter	20
FLAT BAR EASY WAY (in.)	
Size	2
Minimum Diameter	15-3/4
FLAT BAR HARD WAY (in.)	
Size	3/4
Minimum Diameter	6-1/2
ANGLE IRON CAPACITY (in.)	
Size	1-1/4
Minimum Diameter	.30
Shaft Center Distance (in.)	1.18
Lower Roll Diameter (in.)	4.65
Pinch	Single
Shaft Speed (rpm)	2 Speed, 6/12
Electrics	1HP, 230V, 3-Phase
Overall Dimensions (L x W x H / in.)	57-7/8 x 22-53/64 x 21-21/32
Net Weight (lbs.)	420
Gross Weight (lbs.)	435



NEW

MANUAL ROLL BENDER

DURABILITY

- Heavy-duty cast iron construction machined to strict tolerances with maintain tolerances and accuracy
- Hardened rolling shafts with bronze bushings ensures the machine will last for years of operation

EASE OF USE

- Toolless angle stop
- Soft touch handle grips
- With all fingers installed it can be used as a full-length nose bar, turning the machine into a straight bending brake
- Wide assortment of finger widths allows greater versatility in the shop
- Repeat bends are easy with a quick turn of the stop collar on the stop rod
- Counter weights can be moved up or down to provide leverage



STOCK NUMBER	754430K
Model Number	MPR-10V
Type	3 Roll Pyramid Style
Operating Positions	Vertical
PIPE CAPACITY (in. / SCHEDULE 40)	
Size	1
Minimum Diameter	28
ROUND TUBE CAPACITY (in.)	
Size	1-1/4
Minimum Diameter	31-1/2
SQUARE TUBE CAPACITY (in.)	
Size	1-1/4
Minimum Diameter	35
SOLID ROUND CAPACITY (in.)	
Size	7/8
Minimum Diameter	20
FLAT BAR EASY WAY (in.)	
Size	2
Minimum Diameter	15-3/4
FLAT BAR HARD WAY (in.)	
Size	3/4
Minimum Diameter	6-1/2
ANGLE IRON CAPACITY (in.)	
Size	1-1/4
Minimum Diameter	30
Shaft Center Distance (in.)	1.18
Lower Roll Diameter (in.)	4.65
Pinch	Single
Overall Dimensions (L x W x H / in.)	57-7/8 x 22-53/64 x 21-21/32
Net Weight (lbs.)	408
Gross Weight (lbs.)	435



MANUAL PIPE BENDERS

DURABILITY

- Rotating stand locks in three positions for stability and versatility
- Upper and lower heavy-duty wing plate

EASE OF USE

- Simple manual operation for ease-of-use
- Six bending dies included standard for 2" (1/2", 3/4", 1", 1-1/4", 1-1/2", 2")
- Eight bending dies included standard for 3" (1/2", 3/4", 1", 1-1/4", 1-1/2", 2", 2-1/2", 3")
- Heavy-duty hydraulic cylinder capable of bending schedule 40 pipe
- Completely manual so external power is not needed
- Pump the easy-to-use handle to bend pipe
- The inside radius of our pipe benders will produce on all the different size pipes with the 90 degree bend



331900

STOCK NUMBER	331900	331910
Model Number	JHPB-20	JHPB-30
Pipe Size Capacity (in.)	1/2-2	1/2-3
Max. Pipe Wall Thickness (in.)	1/5	6/25
Maximum Load (T)	9	20
Piston Stroke (in.)	10-1/4	12-5/8
Ram Diameter (in.)	1-3/4	2-1/3
Overall Dimensions (L x W x H / in.)	40 x 26 x 28-3/4	40 x 35 x 28-3/4
Net Weight (lbs.)	115	260

PIPE SIZE	INSIDE RADIUS	
1/2"	75mm	2-8/9"
3/4"	94.5mm	3-5/7"
1"	118mm	4-2/3"
1-1/4"	149mm	5-6/7"
1-1/2"	169mm	6-2/3"
2"	212mm	8-1/3"
2-1/2"	262.25mm	10-1/3"
3"	313.75mm	12-1/3"



NEW

PITTSBURGH TYPE LOCKFORMER



DURABILITY

- All steel forming head with hardened and ground shafts
- Case hardened steel forming rolls, machine cut gear for long use
- Needle nose roller bearings for years of precision use
- Reinforced under carriage for damage free lifting with a fork lift

SAFETY

- CSA/US: Following strict guidelines and electrical requirements, this JET Lockformer is CSA/US certified
- Magnetic Switch for motor protection

EASE OF USE

- Toolless roller cover panel for easy access
- Onboard tool storage tray

STOCK NUMBER	756090
Model Number	LF-20
Mild Steel Capacity (ga.)	20
Speed (fpm)	25
DEPTH OF POCKET (in.)	
Width of hammer-over edge (adjustable)	5/16 to 3/8
Electrics	1-1/2HP, 115V, Single Phase
Overall Height (in.)	32
Overall Dimensions (L x W x H / in.)	36 x 16-1/2 x 36-1/2
Net Weight (lbs.)	330
Gross Weight (lbs.)	365

OPTIONAL ACCESSORIES	STOCK NUMBER
Double Seam Attachment	756095
Drive Cleat Attachment	756096



NEW

ELECTRIC PIPE NOTCHER



DURABILITY

- Designed to notch Schedule 40 pipe all day long

SAFETY

- CSA/US: Following strict guidelines and electrical requirements, this JET Notcher is CSA/US certified
- Magnetic switch for low voltage motor protection
- Safety guarding surrounding all notching dies

EASE OF USE

- Insert the end of the pipe, notch one side, rotate pipe 180°, reinsert to notch the other side
- Replacement dies available in wide range of sizes
- Benchtop mounting fits on almost any bench in your shop

STOCK NUMBER	754420
Model Number	ESN-40
Notch Capacity (in. / od)	1/4, 3/8, 1/2, 3/4, 1, 1-1/4, 1-1/2, 2
Maximum Wall Thickness (in.)	1/8
Notching (deg.)	90° fixed angle
Motor (HP)	2 HP, 220V, Single Phase
Overall Dimensions (L x W x H / in.)	33-15/32 x 17-23/32 x 18-57/64
Net Weight (lbs.)	216
Gross Weight (lbs.)	247

OPTIONAL ACCESSORIES	STOCK NUMBER
Replacement Cutter for ESN-40 1/4", 3/8" & 1/2"	754425
Replacement Cutter for ESN-40 3/4", 1" & 1-1/4"	754426
Replacement Cutter for ESN-40 1", 1-1/2" & 2"	754427



NEW

HYDRAULIC NOTCHER



DURABILITY

- Strong casted head for years on use
- Rigid sheet metal stand helps hold accuracies of the cut

SAFETY

- CSA/CUS: Following strict guidelines and electrical requirements, this JET Notcher is CSA/CUS certified
- Blades are guarded to protect the operator
- Emergency stop on both the machine and the foot pedal for quick stoppage of the machine

EASE OF USE

- Blades can be re-sharpened for prolonged life
- Enclosed cabinet with storage shelf
- Table guides with quick locking handles
- Recessed electrics into the side of the cabinet to make it easy to access yet out of the working area of the operator

STOCK NUMBER	754410
Model Number	EMN-9
Maximum Capacity (ga.)	9
Maximum Notcher Dimensions (in.)	7-3/4 x 7-3/4
Fixed Notch Angle	90°
Table Size (L x W / in.)	23.6 x 18
Working Force (T)	22
Strokes per Minute	50
Motor (HP)	3HP, 220V, 3-Phase
Overall Dimensions (L x W x H / in.)	29.68 x 27.8 x 53.78
Net Weight (lbs.)	824
Gross Weight (lbs.)	904



NEW

PNEUMATIC NOTCHER

DURABILITY

- Strong casted head for years on use
- Rigid sheet metal stand helps hold accuracies of the cut

SAFETY

- All blades are guarded to protect the operator

EASE OF USE

- Blades can be re-sharpened many times for a lifetime of savings
- Enclosed cabinet with storage shelf
- 115 PSI Working pressure allows this notcher to be used with almost any standard air compressor



STOCK NUMBER	754405
Model Number	PMN-11
Maximum Capacity (ga.)	11
Maximum Notcher Dimensions (in.)	5x5
Fixed Notch Angle	90°
Maximum Flow Rate (cfm)	4.4
Strokes per minute	50
Working Pressure (psi)	115
Table Size (L x W / in.)	23.6 x 18
Overall Dimensions (L x W x H / in.)	29.68 x 27.8 x 53.78
Net Weight (lbs.)	353
Gross Weight (lbs.)	414



NEW

DUAL STATION ABRASIVE NOTCHER



DURABILITY

- Constructed of heavy-duty gauge steel
- Totally enclosed fan cooled, AC induction motor

SAFETY

- CSA/US: Following strict guidelines and electrical requirements, this JET Notcher is CSA/US certified
- Safety on/off switch

EASE OF USE

- Two station design provides quick easy access, from grinding, notching and deburring at 3 different stations
- Forward and Reverse switch for change of belt direction for standard grinding on rear of machine
- Seven rollers 1/2" to 2-1/2" come standard
- Roll changing made easy and toolless
- Multi-positional hand lever vise
- Designed for quick belt changes
- Two 3" Dust Ports for easy cleanup

STOCK NUMBER	756180	756185
Model Number	DSAN4-1	DSAN4-3
Pipe notching capacity – OD (in.)	1/2 to 2-1/2	1/2 to 2-1/2
Roll Sizes (in.)	1/2, 3/4, 1, 1-1/4, 1-1/2, 2, 2-1/2	1/2, 3/4, 1, 1-1/4, 1-1/2, 2, 2-1/2
Working Height (in.)	40-3/4	40-3/4
Angle Degrees (deg.)	90 to 30	90 to 30
Speed (rpm)	3400	3400
Motor (hp)	3HP, 230V, Single Phase	4HP, 230/460V, 3-Phase
Motor Prewired		230V
Overall Dimensions (L x W x H / in.)	47-1/4 x 23-1/2 x 46-1/2	47-1/4 x 23-1/2 x 46-1/2
Net Weight (lbs.)	414	414



NEW

CORNER NOTCHER

DURABILITY

- Heavy-duty frame for years of notching
- Front cover to keep all dirt and debris away from the lifting spring
- Blade can be reversed for longer cutting life

SAFETY

- Large base increases stability while notching
- Foot pedal curved and covered with non-slip rubber

EASE OF USE

- Spring-assisted foot pedal for ease of use
- Symmetrical design of table and blades for both right & left handed users
- Increased foot pedal to gain mechanical advantage



STOCK NUMBER	755017
Model Number	FN-16
Table Size (in.)	10 x 10
Fixed Notching Angle (deg.)	90
Notching Capacity (in.)	3-1/4 x 3-1/4
Gauge	16
Blade Length (in.)	3
Stroke Length (in.)	1
Overall Dimensions (L x W x H / in.)	16-3/4 x 11-3/4 x 46
Net Weight (lbs.)	180



BENCH HAND NOTCHER

DURABILITY

- Made of cast iron
- Heavy-duty cutting blade

SAFETY

- Blade guard

EASE OF USE

- Capable of notching virtually any shearable material
- Can notch angles of more than 90° through a two-step process
- Easy-to-read front gauges



STOCK NUMBER	756016
Model Number	HN-16T
Cutting Capacity (ga.)	16
Piercing Capacity (ga.)	18
Maximum Notch (in.)	6 x 6
Stroke (in.)	3/4
Overall Dimensions (L x W x H / in.)	24 x 21 x 26
Net Weight (lbs.)	165

OPTIONAL EQUIPMENT	STOCK NUMBER
Stand	754017



45" ENGLISH WHEEL



DURABILITY

- Heavy-duty frame
- Quick wheel change without using any tooling
- Wheels supplied with sealed bearings for smooth operation
- Storage brackets for rolling and anvil wheels
- Retractable casters on all legs make it easy to move around the shop
- All wheels & anvils are polished
- Rolling wheels 6" diameter

EASE OF USE

- Rolls beads and forms mild steel sheet metal up to 16 gauge
- Screw lift assembly designed for comfort and precise pressure setup
- Rolls beads and forms aluminum and copper up to 1/8" thick
- Machine supplied with 10 anvils and 4 rolling wheels
- Three sets of popular fender groove shaping wheels
- Quick cam handle releases the work piece
- Both wheels swivel 90°
- Throat 45"

STOCK NUMBER	756151
Model Number	WH-45T
Frame Tube Sizes (in.)	4 x 4
Throat (in.)	45
Head Opening (in.)	6
Head and Anvil Sit Swivel (deg.)	90
Rolling Wheels Diameter (in.)	6
Overall Dimensions (L x W x H / in.)	64 x 31 x 58
Net Weight (lbs.)	575



24" PLANISHING HAMMER



DURABILITY

- 3-Position airflow regulates speed of pneumatic hammer
- Machine is supplied with an upper and anvil die set
- Front legs with stabilizer bar and 2 back legs makes it extra sturdy

SAFETY

- Front legs with stabilizer bar and 2 back legs makes it extra sturdy
- Machine controlled with 110V foot control

EASE OF USE

- 3-speed regulator is capable of 4,400 – 4,800 / 3,200 – 3,500 / 1,800 – 2,000 blows-per-minute (BPM)
- Smooths beads and forms mild steel sheet metal up to 16 gauge
- Smooths beads and forms aluminum and copper up to 1/8" thick
- 2-die set brackets
- Quick change of upper dies
- Easy to reach adjustable flow valve allows the user to deliver the proper BPM needed for any job

STOCK NUMBER	756121
Model Number	PH-24T
Frame Tube Size (in.)	4 x 4
Throat (in.)	24
Head Opening (in.)	2-1/2
Maximum Pressure (psi)	90
Air Consumption (cfm)	8.8
3-Speed Regulator (blows per min.)	1,800 - 4,600
Noise Level (db)	92.26 - 104.3
Overall Dimensions (L x W x H / in.)	34 x 30 x 61
Net Weight (lbs.)	258



NEW

SHRINKER / STRETCHER

DURABILITY

- Improved frame structure for years of use
- Stand is made of heavy gauge sheet metal for stability

SAFETY

- Rubber non-skid pad on foot pedal

EASE OF USE

- Foot pedal operation leaves the operator hands free
- Mounted on mobile base provides portability and makes it easy to move around the shop
- Handy storage for additional jaws at the operations finger tips
- Forming depth and forming depth are adjustable
- Optional jaws for aluminum materials



STOCK NUMBER		756018
Model Number		MSS-1
Mild Steel Capacity (ga.)		16
Throat Depth (in.)		6
Overall Height (in.)		32
Machine Dimensions (L x W x H / in.)		46-1/2 x 36-7/32 x 16-9/64
Overall Dimensions (L x W x H / in.)		46-1/2 x 19-5/8 x 8-1/4
Net Weight (lbs.)		84
Gross Weight (lbs.)		110

OPTIONAL ACCESSORIES		STOCK NUMBER
Aluminum Shrinker Jaws		755018
Aluminum Stretcher Jaws		755019



HYDRAULIC SHOP PRESSES



331406

DURABILITY

- Side frames are open for inserting long material
- Ram moves laterally for added versatility (15 Ton and 35 Ton models)

SAFETY

- For pressing, bending and straightening operations
- Easy-to-use, hand-operated with pressure gauge for direct pressure readings
- Tables raise and lower easily with use of hand crank on the 15,35 Ton models
- Fast setup ram extension screw

EASE OF USE

- Two bed plates and pump handles
- Straightness testing support uses centers or v-blocks on the 15 & 35 Ton models
- Easy-to-use large hand wheel on 15 & 35 Ton models
- Side frame is open for inserting long material
- Table raises and lowers easily with hand crank on the 15 & 35 Ton models

STOCK NUMBER	331406	331416	331431
Model Number	HP-5A	HP-15A	HP-35A
Capacity (T)	5	15	35
Ram Diameter (in.)	1-3/4	2-1/2	3
Piston Stroke (in.)	4	4-1/2	4-3/4
Screw Stroke (in.)	3	3-1/8	4
Work Table Size (in.)	19 x 5-1/2	24-3/4 x 7-1/2	31 x 10-3/8
Lateral Movement (in.)	N/A	10-3/16	15
Vertical Table Travel (in.)	15-3/4	22-3/16	23-5/8
Overall Dimensions (L x W x H / in.)	24 x 26 x 52	34 x 30 x 66	43 x 34 x 69
Net Weight (lbs.)	192	435	783



ARBOR PRESS

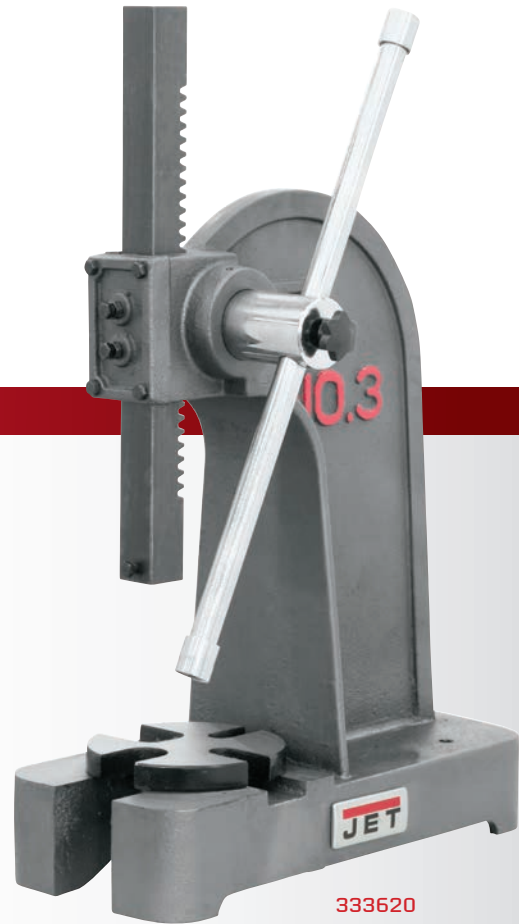

DURABILITY

- Precision cut steel rams and pinions for accurate operation

EASE OF USE

- Tables and slotted table-plates are flat and parallel to provide accurate support
- For all production and assembly applications

STANDARD EQUIPMENT

- Anvil

STOCK NUMBER	333605	333610	333620	333630	333650
Model Number	AP0-M	AP1-M	AP2-M	AP3-M	AP5-M
Diameter of Work (in.)	6-5/8	8	11-3/8	10-3/4	17
Capacity Over Table (in.)	4-3/4	5-7/8	9	12-1/2	18-1/6
Size of Ram Face (in.)	3/4 x 7-7/8	1 x 9-1/8	1-1/4 x 13	1-1/2 x 18	2 x 27-1/2
Approx. Pressure (T)	1/2	1	2	3	5
Ram Bore (in.)	3/8	3/8	1/2	1/2	1/2
Height (in.)	10.9	12	16-1/4	21-1/2	35
Base Size (in.)	4 x 9-1/2	5 x 10-3/4	6-3/8 x 17	8-1/2 x 18	9-7/8 x 26
Net Weight (lbs.)	19	27	68	108	262



FORMING HELPFUL INFO

Jet wants to make your job easier by providing you with some basic and helpful information on all of our Metal Forming products and forming in general.

OVERVIEW

Fashioning metal parts and objects through mechanical deformation reshaping the metal without adding or removing material and its mass remains unchanged. The forming processes applies different stresses to accomplish the deformation. These categories may have many varieties of stresses operating simultaneously, or it may involve stresses which change over the course of the operation.

JET FORMING MACHINES GIVE YOU MULTIPLE CHOICES FOR ALL FORMING PROJECTS.

JET CONVERSION CHART FOR METAL FORMING MACHINES							
MILD STEEL CAPACITY (gauge)	24	22	20	18	16	14	12
Inch	.024	.030	.036	.048	.060	.075	.105
mm	.61	.76	.91	1.2	1.5	1.9	2.7
IRON							
Dead Soft Gauge	24	22	20	18	16	14	12
STEEL							
Low Carbon H.R. (gauge)	24	22	20	18	16	14	12
Low Carbon C.R. (gauge)	24	22	20	18	16	14	12
40% - 50% Carbon H. R. (gauge)	28	26	24	22	20	18	16
1074, 1095 C.R.							
Annealed Spring Steel (gauge)	28	28	24	22	20	18	16
Low Carbon C.R. (gauge)	26	24	22	20	18	18	16
STAINLESS STEEL							
Annealed (gauge)	28	26	24	22	20	18	16
ALUMINUM							
1100-0, 2024-0, 1100-h16	.045	.057	.068	.090	.120	.160	.200
2024-T3, 5052-H34, 6061-T6, 7075-T4	.030	.036	.048	.063	.090	.108	.125
COPPER AND ALLOYS							
Electrolytic Copper	22	20	18	16	14	12	10
Bronze Commercial	22	20	18	16	14	12	10
Brass 70-30 (gauge)	22	20	18	16	14	12	10
NICKEL ALLOYS							
Iconel 600, Monel R405 (gauge)	28	26	24	22	20	18	16
Nickel 200A, Annealed (gauge)	28	26	24	22	20	18	16
ZINC							
As rolled (gauge)	24	22	20	18	16	14	12
PLASTICS							
ABS Compounds	.060	.090	.120	.150	.200	.225	.250
Polycarbonate	.048	.063	.075	.105	.125	.155	.188

JET CONVERSION CHART CONVERTS SHEET METAL GAUGE NUMBERS INTO METAL THICKNESS															
Gauge	26 ga.	24 ga.	22 ga.	20 ga.	18 ga.	16 ga.	14 ga.	13 ga.	12 ga.	11 ga.	10 ga.	9 ga.	8 ga.	7 ga.	6 ga.
Inch	.018"	.024"	.030"	.036"	.048"	.060"	.075"	.090"	.105"	.120"	.135"	.150"	.164"	.180"	.194"
mm	.46 mm	.61 mm	.76 mm	.91 mm	1.2 mm	1.5 mm	1.9 mm	2.3 mm	2.7 mm	3 mm	3.4 mm	3.8 mm	4 mm	4.6 mm	4.9 mm

TYPES OF FORMING MACHINES

Jet offers a wide variety of forming machines to fit your needs. Below is a small sampling.





**THE INDUSTRY'S
MOST DEPENDABLE
SERVICE AND SUPPORT
GUARANTEE**



INDUSTRY LEADING WARRANTIES

All JET® machinery is built to withstand the extreme conditions of industrial job sites. But, every product is backed with industry-leading warranties for added peace of mind. For product and category specific warranty information, please refer to the category introduction pages..

SERVICE & SUPPORT

JET is proud to offer the most extensive service and support program in the industry.

RELIABILITY, EXPERTISE AND DEPENDABILITY

- U.S. Customer Service
- Industry-Leading Warranties
- U.S. Tech Support
- Authorized Service Centers In All 50 States
- Extensive Online Resources
- 40,000+ Unique Parts In Stock

GET PARTS FAST

JET has more than 40,000 parts in stock and ready to ship within 24-48 hours. Our parts are built with the same precision processes as all of our machines. So, when you buy genuine JET parts you can be sure they'll get your machine back up and running fast. JET Product Manuals are readily available to download from our website to help you quickly identify the replacement parts you need.

REAL-TIME TECH SUPPORT

JET provides real-time technical service from our Tennessee offices. Our team has decades of experience using, servicing, and troubleshooting our machines.

Call our tech service hotline 800.274.6848 if you need help with the following:

- Product Setup and Adjustment
- Application-Based Problem Resolution
- Service Call Support
- Warranty & Parts Support.

STAND BEHIND YOUR WORK™

