

EDWARDS
MADE IN THE USA
SINCE 1875

PRODUCT CATALOG

TABLE OF CONTENTS

IRONWORKERS

CHOOSE YOUR IRONWORKER

QUICK REFERENCE GUIDE	4-5
25 TON	6-7
40 TON	8-11
50 TON	12-15
55 TON	16-19
60 TON	20-23
65 TON	24-27
75 TON	28-31
100 TON	32-35
100 TON DELUXE	36-39
120 TON	40-43
ELITE 110 TON	44-47
ELITE 110/65 TON	48-51

IRONWORKER ATTACHMENT & ACCESSORY

QUICK REFERENCE GUIDE	52-53
------------------------------------	-------

POWERLINK™ HYDRAULIC TOOLS

PORTABLE POWER UNIT	56
10 TON BENDER	57
20 TON RADIUS ROLLER	58
20 TON HORIZONTAL PRESS	59
20 TON SHOP PRESSES	60
40 TON SHOP PRESSES	61
60 TON SHOP PRESSES	62-63
110 TON SHOP PRESSES	64-65
ALLIGATOR SHEARS	66
HOLE SAW NOTCHER	67
PUNCH & DIE SETS	68-71
PIPE & TUBE BENDER DIES	72-74

YOUR WORK IS YOUR REPUTATION.

That's why each and every day, you put it all out there for the world to judge. Never stopping and always looking forward to your next challenge. You know what it means to work hard to move the industry ahead one build at a time.

AND SO DO WE.

That is why our focus is a new era of fabrication. Not only do we have the largest line of Ironworkers but we've invented the PowerLink™ System to revolutionize the industry.

BECAUSE WE ARE NEVER CONTENT WITH THE STATUS QUO.

We push harder and dive deeper to provide our customers the products and resources they need to rise to their next build.

BECAUSE WE KNOW IT IS NOT ONLY ABOUT THE BUILD...
IT'S ABOUT BUILDING A REPUTATION.



BUILD YOUR LEGEND™



CHOOSE YOUR IRONWORKER

QUICK REFERENCE GUIDE



	25 TON	40 TON	50 TON	55 TON	60 TON	65 TON
WORKSTATIONS COUNT	2	4	4	4	4	5
WORKSTATIONS DESCRIPTION	Standard (1) Punch	Standard (3) Punch, Flat Bar Shear & Angle Shear	Standard (4) Punch, Flat Bar Shear, Angle Shear & Coper Notcher	Standard (3) Punch, Flat Bar Shear & Angle Shear	Standard (4) Punch, Flat Bar Shear, Angle Shear & Coper Notcher	Standard (4) Punch, Flat Bar Shear, Angle Shear & Coper Notcher
	Open (1)*	Open (1)*	—	Open (1)*	—	Open (1)*
PUNCH RATINGS (TONS)	25	40	50	55	60	65
PUNCH MAX CAPACITY (IN.)	1 diam. in 5/16 mild steel	1 diam. in 1/2 mild steel	1 diam. in 5/8 mild steel	1-1/16 diam. in 5/8 mild steel	1 diam. in 3/4 mild steel	1-1/16 diam. in 3/4 mild steel
FLAT BAR SHEAR MAX CAPACITY (IN.)	—	3/8 x 10 1/2 x 6	1/2 x 10 3/4 x 4	3/8 x 14 1/2 x 12 3/4 x 4	3/8 x 14 1/2 x 12 3/4 x 4	3/8 x 24 1/2 x 14 1 x 4
ANGLE SHEAR MAX CAPACITY (IN.)	—	3 x 3 x 1/4	3 x 3 x 3/8 4 x 4 x 1/4	3 x 3 x 3/8 4 x 4 x 1/4	3 x 3 x 1/2 4 x 4 x 3/8	5 x 5 x 3/8
COPER NOTCHER MAX CAPACITY (IN.)	2 x 3 x 1/4	—	2 x 3 x 5/16	—	2-1/2 x 4 x 5/16	2-1/2 x 5 x 3/8
OPTIONAL COPER NOTCHER MAX CAPACITY (IN.)	—	2 x 3 x 5/16	—	2-1/2 x 4 x 5/16	—	—
MOTOR	1 HP	5 HP	5 HP	5 HP	5 HP	5 or 7.5 HP
POWER LINK AVAILABLE	No	Yes	Yes	Yes	Yes	Yes
ATTACHMENTS	9	11	9	12	9	12
ACCESSORIES	7	16	16	17	17	17
PAGE #	6 - 7	8 - 11	12 - 15	16 - 19	20 - 23	24 - 27

ALL IRONWORKERS 40 TON & LARGER AVAILABLE IN THE FOLLOWING POWER CONFIGURATIONS:
 1 PHASE, 230 VOLT | 3 PHASE, 208 VOLT | 3 PHASE, 230 VOLT | 3 PHASE, 380 VOLT, 50 HZ | 3 PHASE, 460 VOLT | 3 PHASE, 575 VOLT

* Open Workstation accepts optional Attachments to tailor the Ironworker to your needs



	75 TON	100 TON	100 TON DELUXE	120 TON	ELITE 110	ELITE 110/65
WORKSTATIONS COUNT	4	4	5	5	4	5
WORKSTATIONS DESCRIPTION	Standard (4) Punch, Flat Bar Shear, Angle Shear & Coper Notcher	Standard (3) Punch, Flat Bar Shear & Angle Shear	Standard (5) Punch, Flat Bar Shear, Angle Shear, Coper Notcher, & Rod Shear	Standard (4) Punch, Flat Bar Shear, Angle Shear & Coper Notcher	Standard (3) Punch, Flat Bar Shear & Angle Shear	Standard (4) Punch, Flat Bar Shear, Angle Shear & Coper Notcher
	—	Open (1)*	—	Open (1)*	Open (1)*	Open (1)*
PUNCH RATINGS (TONS)	75	100	100	120	110	110/65
PUNCH MAX CAPACITY (IN.)	1-1/16 diam. in 7/8 mild steel	1-1/16 diam. in 1 mild steel	1-1/16 diam. in 1 mild steel	1-1/2 diam. in 1 mild steel	1-3/8 diam. in 1 mild steel	1-3/8 diam. in 1 mild steel
FLAT BAR SHEAR MAX CAPACITY (IN.)	1/2 x 14 3/4 x 10	3/4 x 14 1 x 10	1/2 x 18 3/4 x 14 1 x 10	1/2 x 24 1 x 12	3/4 x 14 1 x 12	3/8 x 24 1/2 x 14 1 x 4
ANGLE SHEAR MAX CAPACITY (IN.)	5 x 5 x 1/2	6 x 6 x 1/2	6 x 6 x 1/2	6 x 6 x 1/2	6 x 6 x 1/2	5 x 5 x 3/8
COPER NOTCHER MAX CAPACITY (IN.)	2-1/2 x 5 x 1/2	—	3 x 6 x 1/2	3 x 6 x 1/2	—	2-1/2 x 6 x 3/8
OPTIONAL COPER NOTCHER MAX CAPACITY (IN.)	—	2-1/2 x 6 x 1/2	—	—	2-1/2 x 6 x 1/2	—
MOTOR	5 or 7.5 HP	5 or 7.5 HP	10 HP	10 HP	7.5 HP	7.5 HP
POWER LINK AVAILABLE	Yes	Yes	Yes	Yes	Standard	Standard
ATTACHMENTS	12	13	10	12	13	12
ACCESSORIES	17	17	16	15	14	14
PAGE #	28 - 31	32 - 35	36 - 39	40 - 43	44 - 47	48 - 51

* Open Workstation accepts optional Attachments to tailor the Ironworker to your needs



25 TON

25 TON ATTACHMENTS & ACCESSORIES



FLEXIBILITY

- **Two workstations:**
 - **Standard (1)** - Punch
 - **Open (1)** - Customize your Ironworker with optional Attachments
- 9 interchangeable Attachments available to tailor the Ironworker to your needs
- 7 optional Accessories available to increase precision and efficiency



PRODUCTIVITY

- Optimized workstation heights for improved efficiency

SAFETY

- ANSI B11.5-1988(O2) Compliant Guarding
- Integrated Lock-out/Tag-out system with E-Stop for added safety

PERFORMANCE

- Durable, heavy-duty, Made In USA steel construction
- Vertical movement produces even pressure resulting in precise punching and shearing with minimal distortion that results in extended tooling life
- Punches are easily changeable, long-lasting and available from 1/8" to 4" diameters along with square, oblong, hex, metric, and custom shapes

SPECIFICATIONS	
Punch Rating (tons)	25
Punch Max Capacity (In.)	1 diam. in 5/16 mild steel
Punch Work Height (In.)	38-1/2
Punch Throat Depth (In.)	5-1/2
Punch Stroke (In.)	1
Open Workstation Work Height (In.)	35-3/4
Open Workstation Throat Depth (In.)	5
Motor	1 HP
Amps	14
Hydraulics (GPM)	11
Hydraulics (PSI)	2750
Hydraulic Reservoir (gal.)	3
Product Dimensions (In.)	29 x 23 x 59
Shipping Dimensions (In.)	45 x 51 x 65
Weight (lbs.)	1200

STOCK #	PRODUCT DESCRIPTION
IW25-1P120	25 Ton Ironworker 1 Phase, 120 Volt
IW25-1P230	25 Ton Ironworker 1 Phase, 230 Volt

ATTACHMENTS



STANDARD PUNCH ASSEMBLY
 • Accommodates punch & dies sets from 1/8" to 1-1/16" diameter
 • Can be used as a secondary Punch Workstation on any Edwards Ironworker with an Open Workstation
AC1023-1*



OVERSIZE PUNCH ASSEMBLY
 • Accommodates punch & die sets in various shapes and sizes from 1" up to 1-9/16"
 • Replaces Standard Punch Assembly or can be used as a secondary Punch Workstation
AC1027*



241 PUNCH ASSEMBLY
 • Accommodates punch & die sets in various shapes and sizes from 1" up to 4"
 • Punch large holes and slots in anything from heavy sheet metal to steel beams
AC1055-1*



ANGLE NOTCHER
 • Take precise 92° notch out of mild steel up to 3" x 3" x 1/4"
 • Allows for an easy 90° to create a steel frame
AC1024*

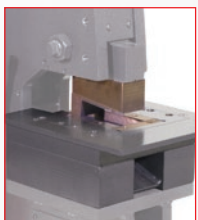

COPER NOTCHER
 • Versatile Attachment that removes anything from a small nibble to a large notch out of Flat Bar or Angle Iron
 • Integrated alignment slots on the safety guarding easily allow for 45° shearing on Angle Iron to speed up your fabrication process
AC1012*



PIPE NOTCHER HOUSING
 • Make clean 90° saddle joint connections quickly and easily
 • Compatible with all Edwards Ironworkers
 • Contact Edwards for custom dies to match your project
 • Pipe Notcher Dies sold separately
AC0925*



MULTI SHEAR
 • Designed to shear flat bar up to 1/4" x 6" and angle iron up to 2" x 2" x 1/4"
 • Shears solid round bar 1/4", 3/8", 1/2", 3/4" and 13/16" square bar
AC1075



ROD SHEAR
 • Shear solid round rod easily with the Rod Shear
 • Handles 1/4", 3/8", 1/2", 5/8", 3/4" and 1" solid round bar
AC1074



7" BRAKE WITH 4-WAY DIE
 • Fabricate brackets, frames, pans and tanks with this Brake with 4-Way Die
 • Includes a standard punch that allows 1/16", 1/8", 3/16" and 1/4" material to be formed to a 90° angle
AC1033

ACCESSORIES



GAUGING TABLE KIT
 • 3/8" thick, 12" x 16" table that adds precision to your Punch Workstation
 • Compatible with both Standard and Oversized Pedestal Die Tables
 • Adjustable fences and handles quickly and easily guide your material for perfect repeatable actions
AC0902-1



STRIPPER REDUCING PLATE
 • Designed to minimize distortion on thinner gauge materials when using 1/2" punches & dies set or smaller
AC1914-1



URETHANE STRIPPER
 • Minimize material distortion when working with light gauge material
AC1099



QUICK CHANGE PUNCH ASSEMBLY
 • Increase your efficiency by saving time and money with the Quick Change Punch Assembly.
 • Accepts both Standard and Oversize Punch & Die Sets
AC1001



PRESS BRAKE BACK GAUGE
 • Speed up production on repeatable bends by providing an adjustable stop for the various size Brake Attachments
 • A positive stop attachment that is fitted to the back of the Ironworker ensures accurate bending
PR135



PUNCH & DIE STARTER SET
 • Includes 8 standard round punch & die sets selected to accommodate the most commonly used bolts
 • Sized in 1/8" increments from 3/16" to 1-1/16" with 1/32" clearance
 • See catalog page 68-71 for additional Punch & Die Sets
PD1000

*IMAGE NOTE: Guarding removed for clarity



40 TON

40 TON



FLEXIBILITY

- **Four workstations:**
 - **Standard (3)** - Punch, Flat Bar Shear & Angle Shear
 - **Open (1)** - Customize your Ironworker with optional Attachments
- 11 interchangeable Attachments available to tailor the Ironworker to your needs
- 16 optional Accessories available to increase precision and efficiency



PRODUCTIVITY

- Compact machine that allows for fast and easy transitions between fabrication operations: punch, shear, notch, bend and cope all in one machine.
- Optimized workstation heights for improved efficiency
- Electric foot pedal with integrated jog control
- Adjustable electric stroke control

SAFETY

- ANSI B11.5-1988(O2) Compliant Guarding
- ETL Certified Controls
- Integrated Lock-out/Tag-out system with E-Stop for added safety

PERFORMANCE

- Durable, heavy-duty, Made In USA steel construction
- Vertical movement produces even pressure resulting in precise punching and shearing with minimal distortion that results in extended tooling life
- Punches are easily changeable, long-lasting and available from 1/8" to 4" diameters along with square, oblong, hex, metric, and custom shapes
- Flat Bar Shear blades are made of precision machined, high-quality tool steel with 4 cutting edges for extended life
- Angle Shear blades have 2 corner radii for both thin and thick material and are made of precision tool steel with 2 cutting edges for extended life

SPECIFICATIONS

Punch Rating (tons)	40
Punch Max Capacity (in.)	1 diam. in 1/2 mild steel
Punch Work Height (in.)	41-1/2
Punch Throat Depth (in.)	7
Punch Stroke (in.)	1-3/8
Flat Bar Shear Max Capacity (in.)	3/8 x 10 1/2 x 6
Flat Bar Shear Work Height (in.)	52-1/2
Flat Bar Shear Max Round Capacity (in.)	1/2 diam.
Flat Bar Shear Max Square Capacity (in.)	1/2
Angle Shear Max Capacity (in.)	3 x 3 x 1/4
Angle Shear Work Height (in.)	52-1/2
Open Workstation Work Height (in.)	35-3/4
Open Workstation Throat Depth (in.)	7-3/4
Opt. Coper Notcher Max Capacity (in.)	2 x 3 x 5/16
Opt. Coper Notcher Work Height (in.)	35-3/4
Motor	5 HP
Amps	23
Hydraulics (GPM)	3-1/2
Hydraulics (PSI)	2750
Hydraulic Reservoir (gal.)	7
Product Dimensions (In.)	32 x 23 x 60-1/2
Shipping Dimensions (In.)	45 x 51 x 67
Weight (lbs.)	1,900

STOCK #	PRODUCT DESCRIPTION
IW40-1P230	40 Ton Ironworker 1 Phase, 230 Volt
IW40-3P208	40 Ton Ironworker 3 Phase, 208 Volt
IW40-3P230	40 Ton Ironworker 3 Phase, 230 Volt
IW40-3P380	40 Ton Ironworker Int'l - 3 Phase, 380 Volt, 50 Hz
IW40-3P460	40 Ton Ironworker 3 Phase, 460 Volt
IW40-3P575	40 Ton Ironworker 3 Phase, 575 Volt
PACKAGES	
40231010	40 Ton Ironworker 1 Phase, 230 Volt, Coper Notcher

THE EXCLUSIVE EDWARDS POWERLINK™ SYSTEM TURNS YOUR 55 TON IRONWORKER INTO A POWER SOURCE FOR OUR EVER INCREASING LINE OF HYDRAULIC TOOLS.

- Simply PLUG IN & POWER UP any of our Hydraulic Tools and expand your fabrication capabilities
- Our factory installed PowerLink System includes quick connect couplings allowing easy transitions between Hydraulic Tools
- The Edwards Portable Power Unit is an additional power source with the PowerLink System



POWER LINK	
STOCK #	PRODUCT DESCRIPTION
IW40-1P230-AC400	40 Ton Ironworker 1 Phase, 230 Volt with PowerLink
IW40-3P208-AC400	40 Ton Ironworker 3 Phase, 208 Volt with PowerLink
IW40-3P230-AC400	40 Ton Ironworker 3 Phase, 230 Volt with PowerLink
IW40-3P380-AC400	40 Ton Ironworker Int'l - 3 Ph, 380 V, 50 Hz with PowerLink
IW40-3P460-AC400	40 Ton Ironworker 3 Phase, 460 Volt with PowerLink
IW40-3P575-AC400	40 Ton Ironworker 3 Phase, 575 Volt with PowerLink
PACKAGES	
40231510	40 Ton Ironworker 1 Phase, 230 Volt, PowerLink, Coper Notcher

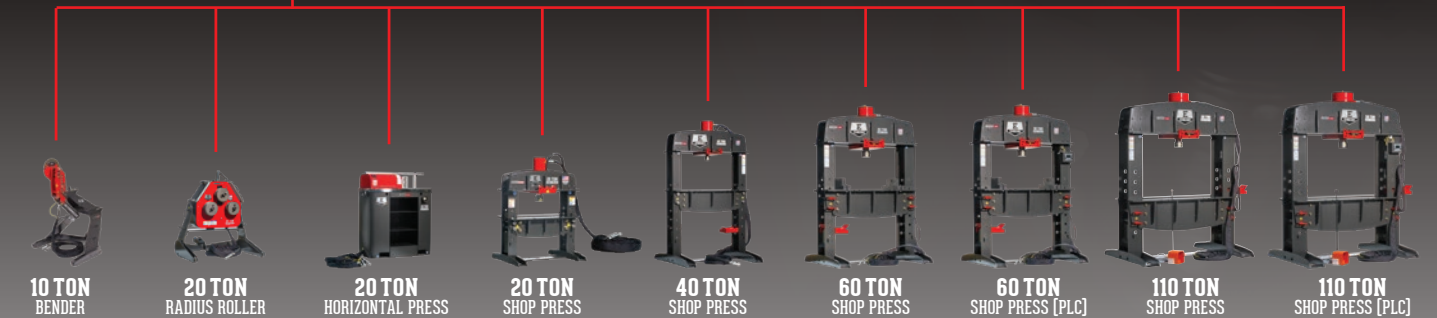

10 TON BENDER, 20 TON RADIUS ROLLER, 20 TON HORIZONTAL PRESS, 20 TON SHOP PRESS, 40 TON SHOP PRESS, 60 TON SHOP PRESS, 60 TON SHOP PRESS [PLC], 110 TON SHOP PRESS, 110 TON SHOP PRESS [PLC]

TURN THE PAGE TO VIEW OUR FULL LINE OF ATTACHMENTS & ACCESSORIES FOR THE 40 TON IRONWORKER



40 TON ATTACHMENTS



STANDARD PUNCH ASSEMBLY

- Accommodates punch & die sets from 1/8" to 1-1/16" diameter
- Can be used as a secondary Punch Workstation on any Edwards Ironworker with an Open Workstation

AC1023-2*



OVERSIZE PUNCH ASSEMBLY

- Accommodates punch & die sets in various shapes and sizes from 1" up to 1-9/16"
- Replaces Standard Punch Assembly or can be used as a secondary Punch Workstation

AC1024*



241 PUNCH ASSEMBLY

- Accommodates punch & die sets in various shapes and sizes from 1" up to 4"
- Punch large holes and slots in anything from heavy sheet metal to steel beams

AC1055*



ANGLE NOTCHER

- Take precise 92° notch out of mild steel up to 3" x 3" x 1/4"
- Allows for an easy 90° to create a steel frame

AC1025-1*



COPER NOTCHER

- Versatile Attachment that removes anything from a small nibble to a large notch out of Flat Bar or Angle Iron
- Integrated alignment slots on the safety guarding easily allow for 45° shearing

AC1013*



PIPE NOTCHER HOUSING

- Make clean 90° saddle joint connections quickly and easily
- Compatible with all Edwards Ironworkers
- Contact Edwards for custom dies to match your project
- Pipe Notcher Dies sold separately

AC0925*



TURRET PIPE NOTCHER

- Make clean 90° saddle joint connections quickly and easily
- Compatible with all Edwards Ironworkers
- Contact Edwards for custom dies to match your project
- Pipe Notcher Dies sold separately

AC0925T*



MULTI SHEAR

- Designed to shear flat bar up to 1/4" x 6" and angle iron up to 2" x 2" x 1/4"
- Shears solid round bar 1/4", 3/8", 1/2", 3/4" and 13/16" square bar

AC1075*



ROD SHEAR

- Shear solid round rod easily with the Rod Shear
- Handles 1/4", 3/8", 1/2", 5/8", 3/4" and 1" solid round bar

AC1074*



BRAKE WITH 4-WAY DIE

- Choose from the sizes listed below to meet your specific needs
- Fabricate brackets, frames, pans and tanks with this Brake with 4-Way Die
- Includes a standard punch that allows 1/16", 1/8", 3/16" and 1/4" material to be formed to a 90° angle

7"

8"

AC1033*

AC1034*

*IMAGE NOTE: Guarding removed for clarity

40 TON ACCESSORIES



GAUGING TABLE KIT

- 3/8" thick, 12" x 16" table that adds precision to your Punch Workstation
- Compatible with both Standard and Oversize Pedestal Die Tables
- Adjustable fences and handles quickly and easily guide your material for perfect repeatable actions

AC0900



HEAVY DUTY GAUGING TABLE KIT

- 1" x 12" x 16" table adds speed and precision to your Punch Workstation
- Replaces Standard Pedestal Die Table
- Adjustable fences and handles quickly and easily guide your material for perfect repeatable actions

AC0903



HEAVY DUTY GAUGING TABLE KIT FOR OVERSIZED PUNCH ASSEMBLY

- 1" x 12" x 16" table adds speed and precision to your Punch Workstation
- Replaces installed Die Table
- Adjustable fences and handles quickly and easily guide your material for perfect repeatable actions

AC0905



STRIPPER REDUCING PLATE

- Designed to minimize distortion on thinner gauge materials when using 1/2" punches & dies set or smaller

AC1914-3



URETHANE STRIPPER

- Minimize material distortion when working with light gauge material

AC1099



QUICK CHANGE PUNCH ASSEMBLY

- Increase your efficiency by saving time and money with the Quick Change Punch Assembly.
- Accepts both Standard and Oversize Punch & Die Sets

AC1001



AUTO CUT - 48"

- Optimize your productivity on both the Flat Bar Shear and Angle Shear Workstations on your Edwards Ironworker
- The adjustable proximity sensor automatically cycles your Ironworker as you feed in material

AC1010



BACK GAUGE - 48"

- Speed up production on repeatable cuts by providing an adjustable stop for the Flat Bar Shear and Angle Shear
- A positive stop attachment that is fitted to the back of the Ironworker ensures accurate shearing

AC1009



PRESS BRAKE BACK GAUGE

- Speed up production on repeatable bends by providing an adjustable stop for the various size Brake Attachments
- A positive stop attachment that is fitted to the back of the Ironworker ensures accurate bending

PR135



PUNCH & DIE STARTER SET

- Includes 8 standard round punch & die sets selected to accommodate the most commonly used bolts
- Sized in 1/8" increments from 3/16" to 1-1/16" with 1/32" clearance
- See catalog page 68-71 for additional Punch & Die Sets

PD1000



ACCESSORY LIGHT

- Super bright LED light with M12 connections plugs
- Powerful magnetic base allows users to attach the light to any Ironworker surface and move as needed

AC1000



FABRICATOR'S PROTRACTOR

- Includes 8 standard round punch & die sets selected to accommodate the most commonly used bolts
- Sized in 1/8" increments from 3/16" to 1-1/16" with 1/32" clearance
- See catalog page 66 for additional Punch & Die Sets

AC1017



12" & 18" FENCES GUIDES

- Easily adjustable to align your material, these 12" or 18" fence guides make precise, repeatable operations simple.

- AC1910 12" Standard Handles
- AC1911 18" Standard Handles
- AC1912 12" Heavy Duty Handles
- AC1913 18" Heavy Duty Handles



PRODUCTIVITY PACK

- Includes 5 Accessories designed to increase your accuracy and production speed.
- Accessory light
- 48" Auto Cut
- Fabricator's Protractor
- 3/8" x 12" x 16" Punch Station table
- Punch & Die Starter Kit

AC2000

*IMAGE NOTE: Guarding removed for clarity



50 TON

50 TON

WITH **POWER LINK™**



FLEXIBILITY

- **Four workstations:**
 - **Standard (4)** - Punch, Flat Bar Shear, Angle Shear & Coper Notcher
- 9 interchangeable Attachments available to tailor the Ironworker to your needs
- 16 optional Accessories available to increase precision and efficiency



PRODUCTIVITY

- Compact machine that allows for fast and easy transitions between fabrication operations: punch, shear, notch, bend and cope all in one machine.
- Optimized workstation heights for improved efficiency
- Electric foot pedal with integrated jog control
- Adjustable electric stroke control

SAFETY

- Bright LED lights increase visibility
- ANSI B11.5-1988(02) Compliant Guarding
- ETL Certified Controls
- Integrated Lock-out/Tag-out system with E-Stop for added safety

PERFORMANCE

- Durable, heavy-duty, Made In USA steel construction
- Vertical movement produces even pressure resulting in precise punching and shearing with minimal distortion that results in extended tooling life
- Punches are easily changeable, long-lasting and available from 1/8" to 4" diameters along with square, oblong, hex, metric, and custom shapes
- Flat Bar Shear blades are made of precision machined, high-quality tool steel with 4 cutting edges for extended life
- Angle Shear blades have 2 corner radii for both thin and thick material and are made of precision tool steel with 2 cutting edges for extended life

SPECIFICATIONS

Punch Rating (tons)	50
Punch Max Capacity (In.)	1 diam. in 5/8 mild steel
Punch Work Height (In.)	39-9/16
Punch Throat Depth (In.)	7
Punch Stroke (In.)	1-7/8
Flat Bar Shear Max Capacity (In.)	1/2 x 10 3/4 x 4
Flat Bar Shear Work Height (In.)	34-1/2
Flat Bar Shear Max Round Capacity (In.)	3/4 diam.
Flat Bar Shear Max Square Capacity (In.)	3/4
Angle Shear Max Capacity (In.)	3 x 3 x 3/8 4 x 4 x 1/4
Angle Shear Work Height (In.)	39-7/8
Coper Notcher Max Capacity (In.)	2 x 3 x 5/16
Coper Notcher Work Height (In.)	39-1/2
Motor	5 HP
Amps	23
Hydraulics (GPM)	3-1/2
Hydraulics (PSI)	2500
Hydraulic Reservoir (gal.)	7
Product Dimensions (In.)	36-3/4 x 36-1/8 x 54-1/2
Shipping Dimensions (In.)	45 x 51 x 62
Weight (lbs.)	2,020

STOCK #	PRODUCT DESCRIPTION
IW50-1P230	50 Ton Ironworker 1 Phase, 230 Volt
IW50-3P208	50 Ton Ironworker 3 Phase, 208 Volt
IW50-3P230	50 Ton Ironworker 3 Phase, 230 Volt
IW50-3P380	50 Ton Ironworker Int'l - 3 Phase, 380 Volt, 50 Hz
IW50-3P460	50 Ton Ironworker 3 Phase, 460 Volt
IW50-3P575	50 Ton Ironworker 3 Phase, 575 Volt

THE EXCLUSIVE EDWARDS POWERLINK™ SYSTEM TURNS YOUR 50 TON IRONWORKER INTO A POWER SOURCE FOR OUR EVER INCREASING LINE OF HYDRAULIC TOOLS.

- Simply PLUG IN & POWER UP any of our Hydraulic Tools and expand your fabrication capabilities
- Our factory installed PowerLink System includes quick connect couplings allowing easy transitions between Hydraulic Tools
- The Edwards Portable Power Unit is an additional power source with the PowerLink System



POWER LINK	
STOCK #	PRODUCT DESCRIPTION
IW50-1P230-AC500	50 Ton Ironworker 1 Phase, 230 Volt with PowerLink
IW50-3P208-AC500	50 Ton Ironworker 3 Phase, 208 Volt with PowerLink
IW50-3P230-AC500	50 Ton Ironworker 3 Phase, 230 Volt with PowerLink
IW50-3P380-AC500	50 Ton Ironworker Int'l - 3 Ph, 380 V, 50 Hz with PowerLink
IW50-3P460-AC500	50 Ton Ironworker 3 Phase, 460 Volt with PowerLink
IW50-3P575-AC500	50 Ton Ironworker 3 Phase, 575 Volt with PowerLink

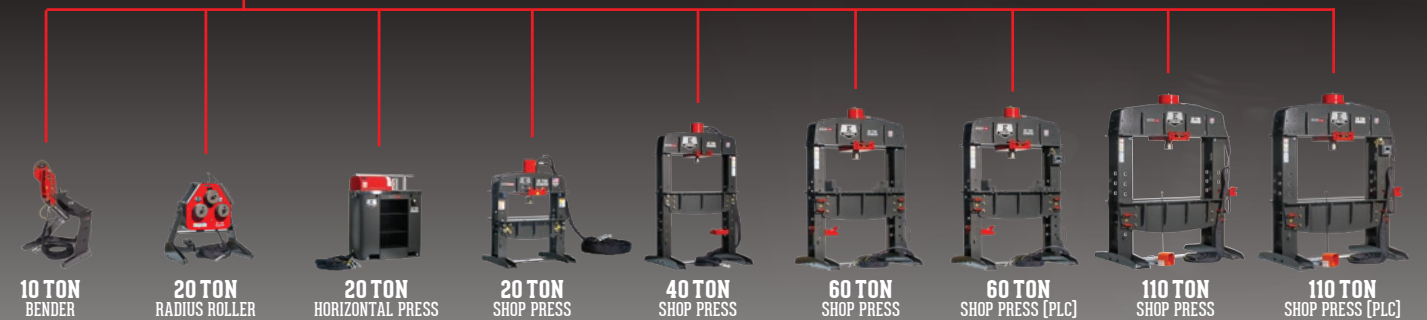

TURN THE PAGE TO VIEW OUR FULL LINE OF ATTACHMENTS & ACCESSORIES FOR THE 50 TON IRONWORKER



50 TON ATTACHMENTS



OVERSIZE PUNCH ASSEMBLY

- Accommodates punch & die sets in various shapes and sizes from 1" up to 1-9/16"
- Replaces Standard Punch Assembly or can be used as a secondary Punch Workstation

AC1024*



241 PUNCH ASSEMBLY

- Accommodates punch & die sets in various shapes and sizes from 1" up to 4"
- Punch large holes and slots in anything from heavy sheet metal to steel beams

AC1055*



ANGLE NOTCHER

- Take precise 92° notch out of mild steel up to 3" x 3" x 1/4"
- Allows for an easy 90° to create a steel frame

AC1025-1*



PIPE NOTCHER HOUSING

- Make clean 90° saddle joint connections quickly and easily
- Compatible with all Edwards Ironworkers
- Contact Edwards for custom dies to match your project
- Pipe Notcher Dies sold separately

AC0925*



TURRET PIPE NOTCHER

- Make clean 90° saddle joint connections quickly and easily
- Compatible with all Edwards Ironworkers
- Contact Edwards for custom dies to match your project
- Pipe Notcher Dies sold separately

AC0925T*



MULTI SHEAR

- Designed to shear flat bar up to 1/4" x 6" and angle iron up to 2" x 2" x 1/4"
- Shears solid round bar 1/4", 3/8", 1/2", 3/4" and 13/16" square bar

AC1075*



ROD SHEAR

- Shear solid round rod easily with the Rod Shear
- Handles 1/4", 3/8", 1/2", 5/8", 3/4" and 1" solid round bar

AC1074*



BRAKE WITH 4-WAY DIE

- Choose from the sizes listed below to meet your specific needs
- Fabricate brackets, frames, pans and tanks with this Brake with 4-Way Die
- Includes a standard punch that allows 1/16", 1/8", 3/16" and 1/4" material to be formed to a 90° angle

7"

AC1033*

8"

AC1034*

*IMAGE NOTE: Guarding removed for clarity

50 TON ACCESSORIES



GAUGING TABLE KIT

- 3/8" thick, 12" x 16" table that adds precision to your Punch Workstation
- Compatible with both Standard and Oversize Pedestal Die Tables
- Adjustable fences and handles quickly and easily guide your material for perfect repeatable actions

AC0900



HEAVY DUTY GAUGING TABLE KIT

- 1" x 12" x 16" table adds speed and precision to your Punch Workstation
- Replaces Standard Pedestal Die Table
- Adjustable fences and handles quickly and easily guide your material for perfect repeatable actions

AC0903



HEAVY DUTY GAUGING TABLE KIT FOR OVERSIZED PUNCH ASSEMBLY

- 1" x 12" x 16" table adds speed and precision to your Punch Workstation
- Replaces installed Die Table
- Adjustable fences and handles quickly and easily guide your material for perfect repeatable actions

AC0905



STRIPPER REDUCING PLATE

- Designed to minimize distortion on thinner gauge materials when using 1/2" punches & dies set or smaller

AC1914-3



URETHANE STRIPPER

- Minimize material distortion when working with light gauge material

AC1099



QUICK CHANGE PUNCH ASSEMBLY

- Increase your efficiency by saving time and money with the Quick Change Punch Assembly.
- Accepts both Standard and Oversize Punch & Die Sets

AC1001



AUTO CUT - 48"

- Optimize your productivity on both the Flat Bar Shear and Angle Shear Workstations on your Edwards Ironworker
- The adjustable proximity sensor automatically cycles your Ironworker as you feed in material

AC1010



BACK GAUGE - 48"

- Speed up production on repeatable cuts by providing an adjustable stop for the Flat Bar Shear and Angle Shear
- A positive stop attachment that is fitted to the back of the Ironworker ensures accurate shearing

AC1011



PRESS BRAKE BACK GAUGE

- Speed up production on repeatable bends by providing an adjustable stop for the various size Brake Attachments
- A positive stop attachment that is fitted to the back of the Ironworker ensures accurate bending

PR135



PUNCH & DIE STARTER SET

- Includes 8 standard round punch & die sets selected to accommodate the most commonly used bolts
- Sized in 1/8" increments from 3/16" to 1-1/16" with 1/32" clearance
- See catalog page 68-71 for additional Punch & Die Sets

PD1000



ACCESSORY LIGHT

- Super bright LED light with M12 connections plugs
- Powerful magnetic base allows users to attach the light to any Ironworker surface and move as needed

AC1000



FABRICATOR'S PROTRACTOR

- Increase user accuracy on the Punch and Flat Bar Shear Workstations
- Designed to guide your workpiece and gauged at 15° increments through 180°

AC1017



12" & 18" FENCES GUIDES

- Easily adjustable to align your material, these 12" or 18" fence guides make precise, repeatable operations simple.

AC1910 12" Standard Handles
AC1911 18" Standard Handles
AC1912 12" Heavy Duty Handles
AC1913 18" Heavy Duty Handles



PRODUCTIVITY PACK

- Includes 5 Accessories designed to increase your accuracy and production speed.
- Accessory light
- 48" Auto Cut
- Fabricator's Protractor
- 3/8" x 12" x 16" Punch Station table
- Punch & Die Starter Kit

AC2000

*IMAGE NOTE: Guarding removed for clarity



55 TON

55 TON



FLEXIBILITY

- **Four workstations:**
 - **Standard (3)** - Punch, Flat Bar Shear & Angle Shear
 - **Open (1)** - Customize your Ironworker with optional Attachments
- 12 interchangeable Attachments available to tailor the Ironworker to your needs
- 17 optional Accessories available to increase precision and efficiency



PRODUCTIVITY

- Compact machine that allows for fast and easy transitions between fabrication operations: punch, shear, notch, bend or cope all in one machine.
- Optimized workstation heights for improved efficiency
- Electric foot pedal with integrated jog control
- Adjustable electric stroke control

SAFETY

- Bright LED lights increase visibility
- ANSI B11.5-1988(O2) Compliant Guarding
- ETL Certified Controls
- Integrated Lock-out/Tag-out system with E-Stop for added safety

PERFORMANCE

- Durable, heavy-duty Made In USA steel construction
- Vertical movement produces even pressure resulting in precise punching and shearing with minimal distortion that results in extended tooling life
- Punches are easily changeable, long-lasting and available from 1/8" to 4" diameters along with square, oblong, hex, metric, and custom shapes

SPECIFICATIONS

Punch Rating (tons)	55
Punch Max Capacity (In.)	1-1/16 diam. in 5/8 mild steel
Punch Work Height (In.)	36-9/16
Punch Throat Depth (In.)	7-1/2
Punch Stroke (In.)	1-1/4
Flat Bar Shear Max Capacity (In.)	3/8 x 14 1/2 x 12 3/4 x 4
Flat Bar Shear Work Height (In.)	34-1/2
Flat Bar Shear Max Round Capacity (In.)	7/8 diam.
Flat Bar Shear Max Square Capacity (In.)	7/8
Angle Shear Max Capacity (In.)	3 x 3 x 3/8 4 x 4 x 1/4
Angle Shear Work Height (In.)	39-7/8
Open Workstation Work Height (In.)	34-1/2
Open Workstation Throat Depth (In.)	11-3/16
Opt. Coper Notcher Max Capacity (in.)	2-1/2 x 4 x 5/16
Opt. Coper Notcher Work Height (in.)	39-1/2
Motor	5 HP
Amps	23
Hydraulics (GPM)	3-1/2
Hydraulics (PSI)	2500
Hydraulic Reservoir (gal.)	7
Product Dimensions (In.)	36-1/8 x 44-3/8 x 55-1/4
Shipping Dimensions (In.)	45 x 51 x 62
Weight (lbs.)	2,480

STOCK #	PRODUCT DESCRIPTION
IW55-1P230	55 Ton Ironworker 1 Phase, 230 Volt
IW55-3P208	55 Ton Ironworker 3 Phase, 208 Volt
IW55-3P230	55 Ton Ironworker 3 Phase, 230 Volt
IW55-3P380	55 Ton Ironworker Int'l - 3 Phase, 380 Volt, 50 Hz
IW55-3P460	55 Ton Ironworker 3 Phase, 460 Volt
IW55-3P575	55 Ton Ironworker 3 Phase, 575 Volt

PACKAGES	
55231012	55 Ton Ironworker 1 Phase, 230 Volt, Coper Notcher
55203512	55 Ton Ironworker 3 Phase, 208 Volt, Coper Notcher
55233012	55 Ton Ironworker 3 Phase, 230 Volt, Coper Notcher
55231022	55 Ton Ironworker 1 Phase, 230 Volt, 10" Brake
55203022	55 Ton Ironworker 3 Phase, 208 Volt, 10" Brake
55233022	55 Ton Ironworker 3 Phase, 230 Volt, 10" Brake

THE EXCLUSIVE EDWARDS POWERLINK™ SYSTEM TURNS YOUR 55 TON IRONWORKER INTO A POWER SOURCE FOR OUR EVER INCREASING LINE OF HYDRAULIC TOOLS.

- Simply PLUG IN & POWER UP any of our Hydraulic Tools and expand your fabrication capabilities
- Our factory installed PowerLink System includes quick connect couplings allowing easy transitions between Hydraulic Tools
- The Edwards Portable Power Unit is an additional power source with the PowerLink System



POWER LINK	
STOCK #	PRODUCT DESCRIPTION
IW55-1P230-AC500	55 Ton Ironworker 1 Phase, 230 Volt with PowerLink
IW55-3P208-AC500	55 Ton Ironworker 3 Phase, 208 Volt with PowerLink
IW55-3P230-AC500	55 Ton Ironworker 3 Phase, 230 Volt with PowerLink
IW55-3P380-AC500	55 Ton Ironworker Int'l - 3 Ph, 380 V, 50 Hz with PowerLink
IW55-3P460-AC500	55 Ton Ironworker 3 Phase, 460 Volt with PowerLink
IW55-3P575-AC500	55 Ton Ironworker 3 Phase, 575 Volt with PowerLink
PACKAGES	
55231512	55 Ton Ironworker 1 Ph, 230 V, PowerLink, Coper Notcher
55203512	55 Ton Ironworker 3 Ph, 208 V, PowerLink, Coper Notcher
55233512	55 Ton Ironworker 3 Ph, 230 V, PowerLink, Coper Notcher
55231522	55 Ton Ironworker 1 Ph, 230 V, PowerLink, 10" Brake
55203522	55 Ton Ironworker 3 Ph, 208 V, PowerLink, 10" Brake
55233522	55 Ton Ironworker 3 Ph, 230 V, PowerLink, 10" Brake

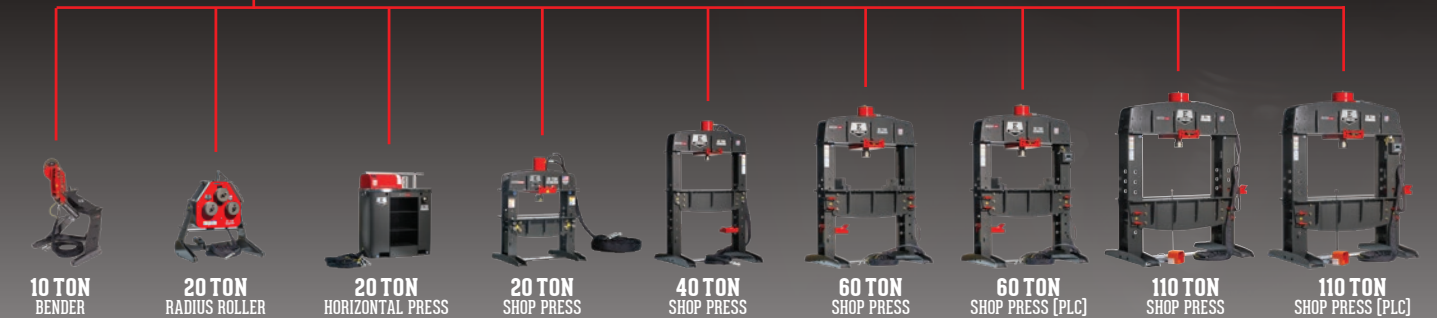

TURN THE PAGE TO VIEW OUR FULL LINE OF ATTACHMENTS & ACCESSORIES FOR THE 55 TON IRONWORKER



55 TON ATTACHMENTS



STANDARD PUNCH ASSEMBLY

- Accommodates punch & dies sets from 1/8" to 1-1/16" diameter
- Can be used as a secondary Punch Workstation on any Edwards Ironworker with an Open Workstation

AC1023-2*



OVERSIZE PUNCH ASSEMBLY

- Accommodates punch & die sets in various shapes and sizes from 1" up to 1-9/16"
- Replaces Standard Punch Assembly or can be used as a secondary Punch Workstation

AC1024*



241 PUNCH ASSEMBLY

- Accommodates punch & die sets in various shapes and sizes from 1" up to 4"
- Punch large holes and slots in anything from heavy sheet metal to steel beams

AC1055*

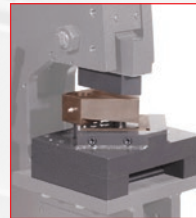

ANGLE NOTCHER

- Take precise 92° notch out of mild steel up to 3" x 3" x 1/4"
- Allows for an easy 90° to create a steel frame

AC1025-1*



COPER NOTCHER

- Versatile Attachment that removes anything from a small nibble to a large notch out of Flat Bar or Angle Iron
- Integrated alignment slots on the safety guarding easily allow for 45° shearing

AC1014*



PIPE NOTCHER HOUSING

- Make clean 90° saddle joint connections quickly and easily
- Compatible with all Edwards Ironworkers
- Contact Edwards for custom dies to match your project
- Pipe Notcher Dies sold separately

AC0925*



TURRET PIPE NOTCHER

- Make clean 90° saddle joint connections quickly and easily
- Compatible with all Edwards Ironworkers
- Contact Edwards for custom dies to match your project
- Pipe Notcher Dies sold separately

AC0925T*



MULTI SHEAR

- Designed to shear flat bar up to 1/4" x 6" and angle iron up to 2" x 2" x 1/4"
- Shears solid round bar 1/4", 3/8", 1/2", 3/4" and 13/16" square bar

AC1075*



ROD SHEAR

- Shear solid round rod easily with the Rod Shear
- Handles 1/4", 3/8", 1/2", 5/8", 3/4" and 1" solid round bar

AC1074*



BRAKE WITH 4-WAY DIE

- Choose from the sizes listed below to meet your specific needs
- Fabricate brackets, frames, pans and tanks with this Brake with 4-Way Die
- Includes a standard punch that allows 1/16", 1/8", 3/16" and 1/4" material to be formed to a 90° angle

7"

8"

10"

AC1033*

AC1034*

AC1051*

55 TON ACCESSORIES



GAUGING TABLE KIT

- 3/8" thick, 12" x 16" table that adds precision to your Punch Workstation
- Compatible with both Standard and Oversize Pedestal Die Tables
- Adjustable fences and handles quickly and easily guide your material for perfect repeatable actions

AC0900



HEAVY DUTY GAUGING TABLE KIT

- 1" x 12" x 16" table adds speed and precision to your Punch Workstation
- Replaces Standard Pedestal Die Table
- Adjustable fences and handles quickly and easily guide your material for perfect repeatable actions

AC0903



HEAVY DUTY GAUGING TABLE KIT FOR OVERSIZED PUNCH ASSEMBLY

- 1" x 12" x 16" table adds speed and precision to your Punch Workstation
- Replaces installed Die Table
- Adjustable fences and handles quickly and easily guide your material for perfect repeatable actions

AC0905



COPER NOTCHER GAUGING TABLE KIT

- Provides a larger 3/8" x 12-1/2" x 15-5/8" size table and two fences to better align your material

AC0800



STRIPPER REDUCING PLATE

- Designed to minimize distortion on thinner gauge materials when using 1/2" punches & dies set or smaller

AC1914-3



URETHANE STRIPPER

- Minimize material distortion when working with light gauge material

AC1099



QUICK CHANGE PUNCH ASSEMBLY

- Increase your efficiency by saving time and money with the Quick Change Punch Assembly
- Accepts both Standard and Oversize Punch & Die Sets

AC1001



AUTO CUT - 48"

- Optimize your productivity on both the Flat Bar Shear and Angle Shear Workstations on your Edwards Ironworker
- The adjustable proximity sensor automatically cycles your Ironworker as you feed in material

AC1010



BACK GAUGE - 48"

- Speed up production on repeatable cuts by providing an adjustable stop for the Flat Bar Shear and Angle Shear
- A positive stop attachment that is fitted to the back of the Ironworker ensures accurate shearing

AC1011

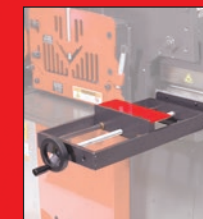

PRESS BRAKE BACK GAUGE

- Speed up production on repeatable bends by providing an adjustable stop for the various size Brake Attachments
- A positive stop attachment that is fitted to the back of the Ironworker ensures accurate bending

PR135



PUNCH & DIE STARTER SET

- Includes 8 standard round punch & die sets selected to accommodate the most commonly used bolts
- Sized in 1/8" increments from 3/16" to 1-1/16" with 1/32" clearance
- See catalog page 68-71 for additional Punch & Die Sets

PD1000



ACCESSORY LIGHT

- Super bright LED light with M12 connections plugs
- Powerful magnetic base allows users to attach the light to any Ironworker surface and move as needed

AC1000



FABRICATOR'S PROTRACTOR

- Increase user accuracy on the Punch and Flat Bar Shear Workstations
- Designed to guide your workpiece and gauged at 15° increments through 180°

AC1017



12" & 18" FENCES GUIDES

- Easily adjustable to align your material, these 12" or 18" fence guides make precise, repeatable operations simple.

AC1910 12" Standard Handles
AC1911 18" Standard Handles
AC1912 12" Heavy Duty Handles
AC1913 18" Heavy Duty Handles



PRODUCTIVITY PACK

- Includes 5 Accessories designed to increase your accuracy and production speed.
- Accessory light
- 48" Auto Cut
- Fabricator's Protractor
- 3/8" x 12" x 16" Punch Station table
- Punch & Die Starter Kit

AC2000

*IMAGE NOTE: Guarding removed for clarity

*IMAGE NOTE: Guarding removed for clarity



60 TON

60 TON

WITH **POWER LINK™**



FLEXIBILITY

- **Four workstations:**
 - **Standard (4)** - Punch, Flat Bar Shear, Angle Shear & Coper Notcher
- 9 interchangeable Attachments available to tailor the Ironworker to your needs
- 17 optional Accessories available to increase precision and efficiency



PRODUCTIVITY

- Compact machine that allows for fast and easy transitions between fabrication operations: punch, shear, notch, bend and cope all in one machine.
- Optimized workstation heights for improved efficiency
- Electric foot pedal with integrated jog control
- Adjustable electric stroke control

SAFETY

- Bright LED lights increase visibility
- ANSI B11.5-1988(02) Compliant Guarding
- ETL Certified Controls
- Integrated Lock-out/Tag-out system with E-Stop for added safety

PERFORMANCE

- Durable, heavy-duty, Made In USA steel construction
- Vertical movement produces even pressure resulting in precise punching and shearing with minimal distortion that results in extended tooling life
- Punches are easily changeable, long-lasting and available from 1/8" to 4" diameters along with square, oblong, hex, metric, and custom shapes
- Flat Bar Shear blades are made of precision machined, high-quality tool steel with 4 cutting edges for extended life
- Angle Shear blades have 2 corner radii for both thin and thick material and are made of precision tool steel with 2 cutting edges for extended life

SPECIFICATIONS

Punch Rating (tons)	60
Punch Max Capacity (In.)	1 diam. In 3/4 mild steel
Punch Work Height (In.)	36-9/16
Punch Throat Depth (In.)	8-7/8
Punch Stroke (In.)	1-1/4
Flat Bar Shear Max Capacity (In.)	3/8 x 14 1/2 x 12 3/4 x 4
Flat Bar Shear Work Height (In.)	34-1/2
Flat Bar Shear Max Round Capacity (In.)	7/8 diam.
Flat Bar Shear Max Square Capacity (In.)	7/8
Angle Shear Max Capacity (In.)	3 x 3 x 1/2 4 x 4 x 3/8
Angle Shear Work Height (In.)	39-7/8
Coper Notcher Max Capacity (In.)	2-1/2 x 4 x 5/16
Coper Notcher Work Height (In.)	39-1/2
Motor	5 HP
Amps	23
Hydraulics (GPM)	3-1/2
Hydraulics (PSI)	2500
Hydraulic Reservoir (gal.)	7
Product Dimensions (In.)	36-1/8 x 46-1/8 x 56-1/8
Shipping Dimensions (In.)	45 x 51 x 63
Weight (lbs.)	2,550

STOCK #	PRODUCT DESCRIPTION
IW60-1P230	60 Ton Ironworker 1 Phase, 230 Volt
IW60-3P208	60 Ton Ironworker 3 Phase, 208 Volt
IW60-3P230	60 Ton Ironworker 3 Phase, 230 Volt
IW60-3P380	60 Ton Ironworker Int'l - 3 Phase, 380 Volt, 50 Hz
IW60-3P460	60 Ton Ironworker 3 Phase, 460 Volt
IW60-3P575	60 Ton Ironworker 3 Phase, 575 Volt

THE EXCLUSIVE EDWARDS POWERLINK™ SYSTEM TURNS YOUR 60 TON IRONWORKER INTO A POWER SOURCE FOR OUR EVER INCREASING LINE OF HYDRAULIC TOOLS.

- Simply PLUG IN & POWER UP any of our Hydraulic Tools and expand your fabrication capabilities
- Our factory installed PowerLink System includes quick connect couplings allowing easy transitions between Hydraulic Tools
- The Edwards Portable Power Unit is an additional power source with the PowerLink System



STOCK #	PRODUCT DESCRIPTION
IW60-1P230-AC500	60 Ton Ironworker 1 Phase, 230 Volt with PowerLink
IW60-3P208-AC500	60 Ton Ironworker 3 Phase, 208 Volt with PowerLink
IW60-3P230-AC500	60 Ton Ironworker 3 Phase, 230 Volt with PowerLink
IW60-3P380-AC500	60 Ton Ironworker Int'l - 3 Ph, 380 V, 50 Hz with PowerLink
IW60-3P460-AC500	60 Ton Ironworker 3 Phase, 460 Volt with PowerLink
IW60-3P575-AC500	60 Ton Ironworker 3 Phase, 575 Volt with PowerLink



10 TON BENDER

20 TON RADIUS ROLLER

20 TON HORIZONTAL PRESS

20 TON SHOP PRESS

40 TON SHOP PRESS

60 TON SHOP PRESS

60 TON SHOP PRESS (PLC)

110 TON SHOP PRESS

110 TON SHOP PRESS (PLC)

TURN THE PAGE TO VIEW OUR FULL LINE OF ATTACHMENTS & ACCESSORIES FOR THE 60 TON IRONWORKER



60 TON ATTACHMENTS



OVERSIZE PUNCH ASSEMBLY

- Accommodates punch & die sets in various shapes and sizes from 1" up to 1-9/16"
- Replaces Standard Punch Assembly or can be used as a secondary Punch Workstation

AC1024*



241 PUNCH ASSEMBLY

- Accommodates punch & die sets in various shapes and sizes from 1" up to 4"
- Punch large holes and slots in anything from heavy sheet metal to steel beams

AC1055*



ANGLE NOTCHER

- Take precise 92° notch out of mild steel up to 3" x 3" x 1/4"
- Allows for an easy 90° to create a steel frame

AC1025-1*



PIPE NOTCHER HOUSING

- Make clean 90° saddle joint connections quickly and easily
- Compatible with all Edwards Ironworkers
- Contact Edwards for custom dies to match your project
- Pipe Notcher Dies sold separately

AC0925*



TURRET PIPE NOTCHER

- Make clean 90° saddle joint connections quickly and easily
- Compatible with all Edwards Ironworkers
- Contact Edwards for custom dies to match your project
- Pipe Notcher Dies sold separately

AC0925T*



MULTI SHEAR

- Designed to shear flat bar up to 1/4" x 6" and angle iron up to 2" x 2" x 1/4"
- Shears solid round bar 1/4", 3/8", 1/2", 3/4" and 13/16" square bar

AC1075*



ROD SHEAR

- Shear solid round rod easily with the Rod Shear
- Handles 1/4", 3/8", 1/2", 5/8", 3/4" and 1" solid round bar

AC1074*



BRAKE WITH 4-WAY DIE

- Choose from the sizes listed below to meet your specific needs
- Fabricate brackets, frames, pans and tanks with this Brake with 4-Way Die
- Includes a standard punch that allows 1/16", 1/8", 3/16" and 1/4" material to be formed to a 90° angle

7"

AC1033*

8"

AC1034*

60 TON ACCESSORIES



GAUGING TABLE KIT

- 3/8" thick, 12" x 16" table that adds precision to your Punch Workstation
- Compatible with both Standard and Oversize Pedestal Die Tables
- Adjustable fences and handles quickly and easily guide your material for perfect repeatable actions

AC0900



HEAVY DUTY GAUGING TABLE KIT

- 1" x 12" x 16" table adds speed and precision to your Punch Workstation
- Replaces Standard Pedestal Die Table
- Adjustable fences and handles quickly and easily guide your material for perfect repeatable actions

AC0903



HEAVY DUTY GAUGING TABLE KIT FOR OVERSIZED PUNCH ASSEMBLY

- 1" x 12" x 16" table adds speed and precision to your Punch Workstation
- Replaces installed Die Table
- Adjustable fences and handles quickly and easily guide your material for perfect repeatable actions

AC0905



COPER NOTCHER GAUGING TABLE KIT

- Provides a larger 3/8" x 12-1/2" x 15-5/8" size table and two fences to better align your material

AC0800



STRIPPER REDUCING PLATE

- Designed to minimize distortion on thinner gauge materials when using 1/2" punches & dies set or smaller

AC1914-3



URETHANE STRIPPER

- Minimize material distortion when working with light gauge material

AC1099



QUICK CHANGE PUNCH ASSEMBLY

- Accommodates punch and increase your efficiency by saving time and money with the Quick Change Punch Assembly.
- Accepts both Standard and Oversize Punch & Die Sets

AC1001



AUTO CUT - 48"

- Optimize your productivity on both the Flat Bar Shear and Angle Shear Workstations on your Edwards Ironworker
- The adjustable proximity sensor automatically cycles your Ironworker as you feed in material

AC1010



BACK GAUGE - 48"

- Speed up production on repeatable cuts by providing an adjustable stop for the Flat Bar Shear and Angle Shear
- A positive stop attachment that is fitted to the back of the Ironworker ensures accurate shearing

AC1011



PRESS BRAKE BACK GAUGE

- Speed up production on repeatable bends by providing an adjustable stop for the various size Brake Attachments
- A positive stop attachment that is fitted to the back of the Ironworker ensures accurate bending

PR135



PUNCH & DIE STARTER SET

- Includes 8 standard round punch & die sets selected to accommodate the most commonly used bolts
- Sized in 1/8" increments from 3/16" to 1-1/16" with 1/32" clearance
- See catalog page 68-71 for additional Punch & Die Sets

PD1000



ACCESSORY LIGHT

- Super bright LED light with M12 connections plugs
- Powerful magnetic base allows users to attach the light to any Ironworker surface and move as needed

AC1000



FABRICATOR'S PROTRACTOR

- Increase user accuracy on the Punch and Flat Bar Shear Workstations
- Designed to guide your workpiece and gauged at 15° increments through 180°

AC1017



12" & 18" FENCES GUIDES

- Easily adjustable to align your material, these 12" or 18" fence guides make precise, repeatable operations simple.

AC1910 12" Standard Handles
AC1911 18" Standard Handles
AC1912 12" Heavy Duty Handles
AC1913 18" Heavy Duty Handles



PRODUCTIVITY PACK

- Includes 5 Accessories designed to increase your accuracy and production speed.
- Accessory light
- 48" Auto Cut
- Fabricator's Protractor
- 3/8" x 12" x 16" Punch Station table
- Punch & Die Starter Kit

AC2000

*IMAGE NOTE: Guarding removed for clarity

*IMAGE NOTE: Guarding removed for clarity



65 TON

65 TON

WITH **POWER LINK™**



FLEXIBILITY

- **Five workstations:**
 - **Standard (4)** - Punch, Flat Bar Shear, Angle Shear & Coper Notcher
 - **Open (1)** - Customize your Ironworker with with 4 optional Attachments - Brake, Rod Shear, Multi-Shear or Pipe Notcher
- 12 interchangeable Attachments available to tailor the Ironworker to your needs
- 17 optional Accessories available to increase precision and efficiency



PRODUCTIVITY

- Compact machine that allows for fast and easy transitions between fabrication operations: punch, shear, notch, bend and cope all in one machine.
- Optimized workstation heights for improved efficiency
- Electric foot pedal with integrated jog control
- Adjustable electric stoke control

SAFETY

- Bright LED lights increase visibility
- ANSI B11.5-1988(O2) Compliant Guarding
- ETL Certified Controls
- Integrated Lock-out/Tag-out system with E-Stop for added safety

PERFORMANCE

- Durable, heavy-duty, Made In USA steel construction
- Vertical movement produces even pressure resulting in precise punching and shearing with minimal distortion that results in extended tooling life
- Punches are easily changeable, long-lasting and available from 1/8" to 4" diameters along with square, oblong, hex, metric, and custom shapes
- Flat Bar Shear blades are made of precision machined, high-quality tool steel with 4 cutting edges for extended life
- Angle Shear blades have 2 corner radii for both thin and thick material and are made of precision tool steel with 2 cutting edges for extended life

STOCK #	PRODUCT DESCRIPTION
IW65-1P230	65 Ton Ironworker 1 Phase, 230 Volt
IW65-3P208	65 Ton Ironworker 3 Phase, 208 Volt
IW65-3P230	65 Ton Ironworker 3 Phase, 230 Volt
IW65-3P380	65 Ton Ironworker Int'l - 3 Phase, 380 Volt, 50 Hz
IW65-3P460	65 Ton Ironworker 3 Phase, 460 Volt
IW65-3P575	65 Ton Ironworker 3 Phase, 575 Volt

SPECIFICATIONS

Punch Rating (tons)	65
Punch Max Capacity (In.)	1-1/16 diam. in 3/4 mild steel
Punch Work Height (In.)	36-9/16
Punch Throat Depth (In.)	9-3/4
Punch Stroke (In.)	1-13/16
Flat Bar Shear Max Capacity (In.)	3/8 x 24 1/2 x 14 1 x 4
Flat Bar Shear Work Height (In.)	34-1/2
Flat Bar Shear Max Round Capacity (In.)	1 diam.
Flat Bar Shear Max Square Capacity (In.)	1
Angle Shear Max Capacity (In.)	5 x 5 x 3/8
Angle Shear Work Height (In.)	43-1/2
Coper Notcher Max Capacity (In.)	2-1/2 x 5 x 3/8
Coper Notcher Work Height (In.)	39-1/2
Open Cavity Height (In.)	8-3/4
Open Cavity Width (In.)	12
Open Cavity Work Height (In.)	43
Motor	5 or 7.5 HP
Amps	23
Hydraulics (GPM)	10-1/2
Hydraulics (PSI)	3500
Hydraulic Reservoir (gal.)	17
Product Dimensions (In.)	45 x 62-1/8 x 57
Shipping Dimensions (In.)	46 x 69 x 63
Weight (lbs.)	4,750



THE EXCLUSIVE EDWARDS POWERLINK™ SYSTEM TURNS YOUR 65 TON IRONWORKER INTO A POWER SOURCE FOR OUR EVER INCREASING LINE OF HYDRAULIC TOOLS.

- Simply PLUG IN & POWER UP any of our Hydraulic Tools and expand your fabrication capabilities
- Our factory installed PowerLink System includes quick connect couplings allowing easy transitions between Hydraulic Tools
- The Edwards Portable Power Unit is an additional power source with the PowerLink System

STOCK #	PRODUCT DESCRIPTION
IW65-1P230-AC700	65 Ton Ironworker 1 Phase, 230 Volt with PowerLink
IW65-3P208-AC600	65 Ton Ironworker 3 Phase, 208 Volt with PowerLink
IW65-3P230-AC600	65 Ton Ironworker 3 Phase, 230 Volt with PowerLink
IW65-3P380-AC600	65 Ton Ironworker Int'l - 3 Ph, 380 V, 50 Hz with PowerLink
IW65-3P460-AC600	65 Ton Ironworker 3 Phase, 460 Volt with PowerLink
IW65-3P575-AC600	65 Ton Ironworker 3 Phase, 575 Volt with PowerLink



TURN THE PAGE TO VIEW OUR FULL LINE OF ATTACHMENTS & ACCESSORIES FOR THE 65 TON IRONWORKER



65 TON ATTACHMENTS



OVERSIZE PUNCH ASSEMBLY

- Accommodates punch & die sets in various shapes and sizes from 1" up to 1-9/16"
- Replaces Standard Punch Assembly or can be used as a secondary Punch Workstation

AC1024*



241 PUNCH ASSEMBLY

- Accommodates punch & die sets in various shapes and sizes from 1" up to 4"
- Punch large holes and slots in anything from heavy sheet metal to steel beams

AC1055-2*



ANGLE NOTCHER

- Take precise 92° notch out of mild steel up to 3" x 3" x 1/4"
- Allows for an easy 90° to create a steel frame

AC1025*



PIPE NOTCHER HOUSING

- Make clean 90° saddle joint connections quickly and easily
- Compatible with all Edwards Ironworkers
- Contact Edwards for custom dies to match your project
- Pipe Notcher Dies sold separately

AC0925*

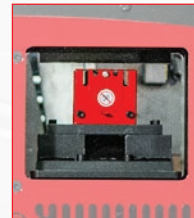

PIPE NOTCHER HOUSING FOR OPEN CAVITY

- Make clean 90° saddle joint connections quickly and easily
- Compatible with the 65,120, and 110/65 Ton Elite Ironworkers
- Contact Edwards for custom dies to match your project
- Pipe Notcher Dies sold separately

AC0925C**



TURRET PIPE NOTCHER

- Make clean 90° saddle joint connections quickly and easily
- Compatible with all Edwards Ironworkers
- Contact Edwards for custom dies to match your project
- Pipe Notcher Dies sold separately

AC0925T*



MULTI SHEAR

- Designed to shear flat bar up to 1/4" x 6" and angle iron up to 2" x 2" x 1/4"
- Shears solid round bar 1/4", 3/8", 1/2", 3/4" and 13/16" square bar

AC1075*



ROD SHEAR

- Shear solid round rod easily with the Rod Shear
- Handles 1/4", 3/8", 1/2", 5/8", 3/4" and 1" solid round bar

AC1074*



BRAKE WITH 4-WAY DIE

- Choose from the sizes listed below to meet your specific needs
- Fabricate brackets, frames, pans and tanks with this Brake with 4-Way Die
- Includes a standard punch that allows 1/16", 1/8", 3/16" and 1/4" material to be formed to a 90° angle

7"	8"	10"	10" OPEN CAVITY
AC1033*	AC1034*	AC1051*	AC1052*

65 TON ACCESSORIES



GAUGING TABLE KIT

- 3/8" thick, 12" x 16" table that adds precision to your Punch Workstation
- Compatible with both Standard and Oversize Pedestal Die Tables
- Adjustable fences and handles quickly and easily guide your material for perfect repeatable actions

AC0800



HEAVY DUTY GAUGING TABLE KIT

- 1" x 12" x 16" table adds speed and precision to your Punch Workstation
- Replaces Standard Pedestal Die Table
- Adjustable fences and handles quickly and easily guide your material for perfect repeatable actions

AC0903



HEAVY DUTY GAUGING TABLE KIT FOR OVERSIZED PUNCH ASSEMBLY

- 1" x 12" x 16" table adds speed and precision to your Punch Workstation
- Replaces installed Die Table
- Adjustable fences and handles quickly and easily guide your material for perfect repeatable actions

AC0905



COPER NOTCHER GAUGING TABLE KIT

- Provides a larger 3/8" x 12-1/2" x 15-5/8" size table and two fences to better align your material

AC0800



STRIPPER REDUCING PLATE

- Designed to minimize distortion on thinner gauge materials when using 1/2" punches & dies set or smaller

AC1914-4



URETHANE STRIPPER

- Minimize material distortion when working with light gauge material

AC1099



QUICK CHANGE PUNCH ASSEMBLY

- Accommodates punch and die sets in various shapes and sizes
- Increase your efficiency by saving time and money with the Quick Change Punch Assembly.
- Accepts both Standard and Oversize Punch & Die Sets

AC1001



AUTO CUT - 48"

- Optimize your productivity on both the Flat Bar Shear and Angle Shear Workstations on your Edwards Ironworker
- The adjustable proximity sensor automatically cycles your Ironworker as you feed in material

AC1010



BACK GAUGE - 48"

- Speed up production on repeatable cuts by providing an adjustable stop for the Flat Bar Shear and Angle Shear
- A positive stop attachment that is fitted to the back of the Ironworker ensures accurate shearing

AC1011



PRESS BRAKE BACK GAUGE

- Speed up production on repeatable bends by providing an adjustable stop for the various size Brake Attachments
- A positive stop attachment that is fitted to the back of the Ironworker ensures accurate bending

PR135



PUNCH & DIE STARTER SET

- Includes 8 standard round punch & die sets selected to accommodate the most commonly used bolts
- Sized in 1/8" increments from 3/16" to 1-1/16" with 1/32" clearance
- See catalog page 68-71 for additional Punch & Die Sets

PD1000



ACCESSORY LIGHT

- Super bright LED light with M12 connections plugs
- Powerful magnetic base allows users to attach the light to any Ironworker surface and move as needed

AC1000



FABRICATOR'S PROTRACTOR

- Increase user accuracy on the Punch and Flat Bar Shear Workstations
- Designed to guide your workpiece and gauged at 15° increments through 180°

AC1017



12" & 18" FENCES GUIDES

- Easily adjustable to align your material, these 12" or 18" fence guides make precise, repeatable operations simple.

AC1910 12" Standard Handles
AC1911 18" Standard Handles
AC1912 12" Heavy Duty Handles
AC1913 18" Heavy Duty Handles



PRODUCTIVITY PACK

- Includes 5 Accessories designed to increase your accuracy and production speed.
- Accessory light
- 48" Auto Cut
- Fabricator's Protractor
- 3/8" x 12" x 16" Punch Station table
- Punch & Die Starter Kit

AC2000

*IMAGE NOTE: Guarding removed for clarity

*IMAGE NOTE: Guarding removed for clarity



75 TON

75 TON

WITH **POWER LINK™**



FLEXIBILITY

- **Four workstations:**
 - **Standard (4)** - Punch, Flat Bar Shear, Angle Shear & Coper Notcher
- 12 interchangeable Attachments available to tailor the Ironworker to your needs
- 17 optional Accessories available to increase precision and efficiency



PRODUCTIVITY

- Compact machine that allows for fast and easy transitions between fabrication operations: punch, shear, notch, bend and cope all in one machine.
- Optimized workstation heights for improved efficiency
- Electric foot pedal with integrated jog control
- Adjustable electric stroke control

SAFETY

- Bright LED lights increase visibility
- ANSI B11.5-1988(02) Compliant Guarding
- ETL Certified Controls
- Integrated Lock-out/Tag-out system with E-Stop for added safety

PERFORMANCE

- Durable, heavy-duty, Made In USA steel construction
- Vertical movement produces even pressure resulting in precise punching and shearing with minimal distortion that results in extended tooling life
- Punches are easily changeable, long-lasting and available from 1/8" to 4" diameters along with square, oblong, hex, metric, and custom shapes
- Flat Bar Shear blades are made of precision machined, high-quality tool steel with 4 cutting edges for extended life
- Angle Shear blades have 2 corner radii for both thin and thick material and are made of precision tool steel with 2 cutting edges for extended life

SPECIFICATIONS

Punch Rating (tons)	75
Punch Max Capacity (In.)	1-1/16 diam. in 7/8 mild steel
Punch Work Height (In.)	39-1/16
Punch Throat Depth (In.)	10
Punch Stroke (In.)	1-13/16
Flat Bar Shear Max Capacity (In.)	1/2 x 14 3/4 x 10
Flat Bar Shear Work Height (In.)	37
Flat Bar Shear Max Round Capacity (In.)	1 diam.
Flat Bar Shear Max Square Capacity (In.)	1
Angle Shear Max Capacity (In.)	5 x 5 x 1/2
Angle Shear Work Height (In.)	43-15/16
Coper Notcher Max Capacity (In.)	2-1/2 x 5 x 1/2
Coper Notcher Work Height (In.)	42
Motor	5 or 7.5 HP
Amps	23
Hydraulics (GPM)	10-1/2
Hydraulics (PSI)	3500
Hydraulic Reservoir (gal.)	17
Product Dimensions (In.)	45 x 50 x 60 1/4
Shipping Dimensions (In.)	46 x 69 x 63
Weight (lbs.)	4,100

STOCK #	PRODUCT DESCRIPTION
IW75-1P230	75 Ton Ironworker 1 Phase, 230 Volt
IW75-3P208	75 Ton Ironworker 3 Phase, 208 Volt
IW75-3P230	75 Ton Ironworker 3 Phase, 230 Volt
IW75-3P380	75 Ton Ironworker Int'l - 3 Phase, 380 Volt, 50 Hz
IW75-3P460	75 Ton Ironworker 3 Phase, 460 Volt
IW75-3P575	75 Ton Ironworker 3 Phase, 575 Volt

THE EXCLUSIVE EDWARDS POWERLINK™ SYSTEM TURNS YOUR 75 TON IRONWORKER INTO A POWER SOURCE FOR OUR EVER INCREASING LINE OF HYDRAULIC TOOLS.

- Simply PLUG IN & POWER UP any of our Hydraulic Tools and expand your fabrication capabilities
- Our factory installed PowerLink System includes quick connect couplings allowing easy transitions between Hydraulic Tools
- The Edwards Portable Power Unit is an additional power source with the PowerLink System



STOCK #	PRODUCT DESCRIPTION
IW75-1P230-AC700	75 Ton Ironworker 1 Phase, 230 Volt with PowerLink
IW75-3P208-AC600	75 Ton Ironworker 3 Phase, 208 Volt with PowerLink
IW75-3P230-AC600	75 Ton Ironworker 3 Phase, 230 Volt with PowerLink
IW75-3P380-AC600	75 Ton Ironworker Int'l - 3 Ph, 380 V, 50 Hz with PowerLink
IW75-3P460-AC600	75 Ton Ironworker 3 Phase, 460 Volt with PowerLink
IW75-3P575-AC600	75 Ton Ironworker 3 Phase, 575 Volt with PowerLink

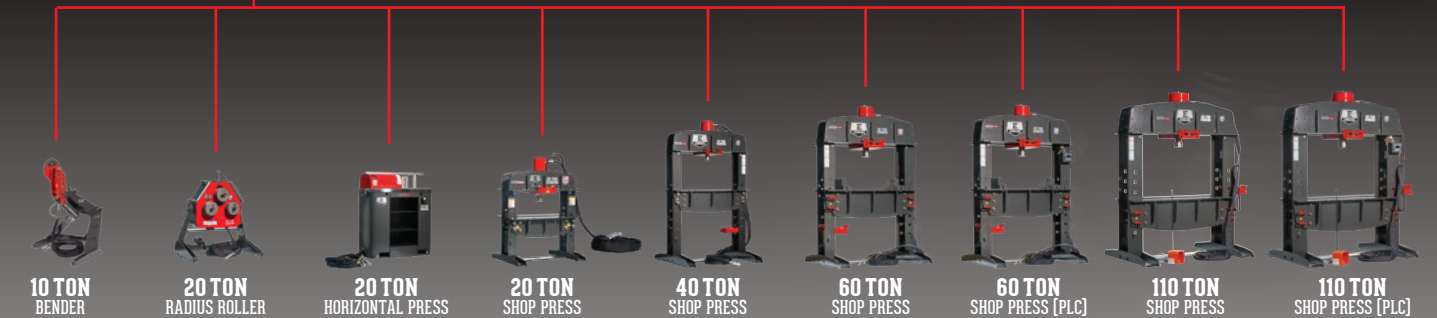

TURN THE PAGE TO VIEW OUR FULL LINE OF ATTACHMENTS & ACCESSORIES FOR THE 75 TON IRONWORKER



75 TON ATTACHMENTS



OVERSIZE PUNCH ASSEMBLY

- Accommodates punch & die sets in various shapes and sizes from 1" up to 1-9/16"
- Replaces Standard Punch Assembly or can be used as a secondary Punch Workstation

AC1024*



241 PUNCH ASSEMBLY

- Accommodates punch & die sets in various shapes and sizes from 1" up to 4"
- Punch large holes and slots in anything from heavy sheet metal to steel beams

AC1055-2*



ANGLE NOTCHER

- Take precise 92° notch out of mild steel up to 3" x 3" x 1/4"
- Allows for an easy 90° to create a steel frame

AC1025*



PIPE NOTCHER HOUSING

- Make clean 90° saddle joint connections quickly and easily
- Compatible with all Edwards Ironworkers
- Contact Edwards for custom dies to match your project
- Pipe Notcher Dies sold separately

AC0925*



TURRET PIPE NOTCHER

- Make clean 90° saddle joint connections quickly and easily
- Compatible with all Edwards Ironworkers
- Contact Edwards for custom dies to match your project
- Pipe Notcher Dies sold separately

AC0925T*



MULTI SHEAR

- Designed to shear flat bar up to 1/4" x 6" and angle iron up to 2" x 2" x 1/4"
- Shears solid round bar 1/4", 3/8", 1/2", 3/4" and 13/16" square bar

AC1075*



ROD SHEAR

- Shear solid round rod easily with the Rod Shear
- Handles 1/4", 3/8", 1/2", 5/8", 3/4" and 1" solid round bar

AC1074*



BRAKE WITH 4-WAY DIE

- Choose from the sizes listed below to meet your specific needs
- Fabricate brackets, frames, pans and tanks with this Brake with 4-Way Die
- Includes a standard punch that allows 1/16", 1/8", 3/16" and 1/4" material to be formed to a 90° angle

7"	8"	10"	12"
AC1033*	AC1034*	AC1051*	AC1035*

75 TON ACCESSORIES



GAUGING TABLE KIT

- 3/8" thick, 12" x 16" table that adds precision to your Punch Workstation
- Compatible with both Standard and Oversize Pedestal Die Tables
- Adjustable fences and handles quickly and easily guide your material for perfect repeatable actions

AC0900



HEAVY DUTY GAUGING TABLE KIT

- 1" x 12" x 16" table adds speed and precision to your Punch Workstation
- Replaces Standard Pedestal Die Table
- Adjustable fences and handles quickly and easily guide your material for perfect repeatable actions

AC0903



HEAVY DUTY GAUGING TABLE KIT FOR OVERSIZED PUNCH ASSEMBLY

- 1" x 12" x 16" table adds speed and precision to your Punch Workstation
- Replaces installed Die Table
- Adjustable fences and handles quickly and easily guide your material for perfect repeatable actions

AC0905



COPER NOTCHER GAUGING TABLE KIT

- Provides a larger 3/8" x 12-1/2" x 15-5/8" size table and two fences to better align your material

AC0800



STRIPPER REDUCING PLATE

- Designed to minimize distortion on thinner gauge materials when using 1/2" punches & dies set or smaller

AC1914-4



URETHANE STRIPPER

- Minimize material distortion when working with light gauge material

AC1099



QUICK CHANGE PUNCH ASSEMBLY

- Accommodates punch and increase your efficiency by saving time and money with the Quick Change Punch Assembly.
- Accepts both Standard and Oversize Punch & Die Sets

AC1001



AUTO CUT - 48"

- Optimize your productivity on both the Flat Bar Shear and Angle Shear Workstations on your Edwards Ironworker
- The adjustable proximity sensor automatically cycles your Ironworker as you feed in material

AC1010

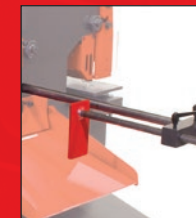

BACK GAUGE - 48"

- Speed up production on repeatable cuts by providing an adjustable stop for the Flat Bar Shear and Angle Shear
- A positive stop attachment that is fitted to the back of the Ironworker ensures accurate shearing

AC1011



PRESS BRAKE BACK GAUGE

- Speed up production on repeatable bends by providing an adjustable stop for the various size Brake Attachments
- A positive stop attachment that is fitted to the back of the Ironworker ensures accurate bending

PR135



PUNCH & DIE STARTER SET

- Includes 8 standard round punch & die sets selected to accommodate the most commonly used bolts
- Sized in 1/8" increments from 3/16" to 1-1/16" with 1/32" clearance
- See catalog page 68-71 for additional Punch & Die Sets

PD1000



ACCESSORY LIGHT

- Super bright LED light with M12 connections plugs
- Powerful magnetic base allows users to attach the light to any Ironworker surface and move as needed

AC1000



FABRICATOR'S PROTRACTOR

- Increase user accuracy on the Punch and Flat Bar Shear Workstations
- Designed to guide your workpiece and gauged at 15° increments through 180°

AC1017



12" & 18" FENCES GUIDES

- Easily adjustable to align your material, these 12" or 18" fence guides make precise, repeatable operations simple.

AC1910 12" Standard Handles
AC1911 18" Standard Handles
AC1912 12" Heavy Duty Handles
AC1913 18" Heavy Duty Handles



PRODUCTIVITY PACK

- Includes 5 Accessories designed to increase your accuracy and production speed.
- Accessory light
- 48" Auto Cut
- Fabricator's Protractor
- 3/8" x 12" x 16" Punch Station table
- Punch & Die Starter Kit

AC2000

*IMAGE NOTE: Guarding removed for clarity

*IMAGE NOTE: Guarding removed for clarity



100 TON



SPECIFICATIONS

Punch Rating (tons)	100
Punch Max Capacity (in.)	1-1/16 diam. In 1 mild steel
Punch Work Height (in.)	39-1/16
Punch Throat Depth (in.)	11
Punch Stroke (in.)	1-13/16
Flat Bar Shear Max Capacity (in.)	3/4 x 14 1 x 10
Flat Bar Shear Work Height (in.)	37
Flat Bar Shear Max Round Capacity (in.)	1-1/4 diam.
Flat Bar Shear Max Square Capacity (in.)	1-1/4
Angle Shear Max Capacity (in.)	6 x 6 x 1/2
Angle Shear Work Height (in.)	43-15/16
Open Workstation Work Height (in.)	37
Open Workstation Throat Depth (in.)	14-3/4
Opt. Coper Notcher Max Capacity (in.)	2-1/2 x 6 x 1/2
Opt. Coper Notcher Work Height (in.)	42
Motor	5 or 7.5 HP
Amps	23
Hydraulics (GPM)	10-1/2
Hydraulics (PSI)	3500
Hydraulic Reservoir (gal.)	17
Product Dimensions (In.)	45 x 56-1/8 x 61-11/16
Shipping Dimensions (In.)	46 x 69 x 67
Weight (lbs.)	4,650

FLEXIBILITY

- **Four workstations:**
 - **Standard (3)** - Punch, Flat Bar Shear & Angle Shear
 - **Open (1)** - Customize your Ironworker with optional Attachments
- 13 interchangeable Attachments available to tailor the Ironworker to your needs
- 17 optional Accessories available to increase precision and efficiency



PRODUCTIVITY

- Compact machine that allows for fast and easy transitions between fabrication operations: punch, shear, notch, bend and cope all in one machine.
- Optimized workstation heights for improved efficiency
- Electric foot pedal with integrated jog control
- Adjustable electric stroke control

SAFETY

- Bright LED lights increase visibility
- ANSI B11.5-1988(O2) Compliant Guarding
- ETL Certified Controls
- Integrated Lock-out/Tag-out system with E-Stop for added safety

PERFORMANCE

- Durable, heavy-duty, Made In USA steel construction
- Vertical movement produces even pressure resulting in precise punching and shearing with minimal distortion that results in extended tooling life
- Punches are easily changeable, long-lasting and available from 1/8" to 4" diameters along with square, oblong, hex, metric, and custom shapes
- Flat Bar Shear blades are made of precision machined, high-quality tool steel with 4 cutting edges for extended life
- Angle Shear blades have 2 corner radii for both thin and thick material and are made of precision tool steel with 2 cutting edges for extended life

STOCK #	PRODUCT DESCRIPTION
IW100-1P230	100 Ton Ironworker 1 Phase, 230 Volt
IW100-3P208	100 Ton Ironworker 3 Phase, 208 Volt
IW100-3P230	100 Ton Ironworker 3 Phase, 230 Volt
IW100-3P380	100 Ton Ironworker Int'l - 3 Phase, 380 Volt, 50 Hz
IW100-3P460	100 Ton Ironworker 3 Phase, 460 Volt
IW100-3P575	100 Ton Ironworker 3 Phase, 575 Volt

100 TON



THE EXCLUSIVE EDWARDS POWERLINK™ SYSTEM TURNS YOUR 100 TON IRONWORKER INTO A POWER SOURCE FOR OUR EVER INCREASING LINE OF HYDRAULIC TOOLS.

- Simply PLUG IN & POWER UP any of our Hydraulic Tools and expand your fabrication capabilities
- Our factory installed PowerLink System includes quick connect couplings allowing easy transitions between Hydraulic Tools
- The Edwards Portable Power Unit is an additional power source with the PowerLink System



POWER LINK

STOCK #	PRODUCT DESCRIPTION
IW100-1P230-AC700	100 Ton Ironworker 1 Phase, 230 Volt with PowerLink
IW100-3P208-AC600	100 Ton Ironworker 3 Phase, 208 Volt with PowerLink
IW100-3P230-AC600	100 Ton Ironworker 3 Phase, 230 Volt with PowerLink
IW100-3P380-AC600	100 Ton Ironworker Int'l - 3 Ph, 380 V, 50 Hz with PowerLink
IW100-3P460-AC600	100 Ton Ironworker 3 Phase, 460 Volt with PowerLink
IW100-3P575-AC600	100 Ton Ironworker 3 Phase, 575 Volt with PowerLink
PACKAGES	
10233512	100 Ton Ironworker 3 Phase, 230 Volt, PowerLink, Coper Notcher

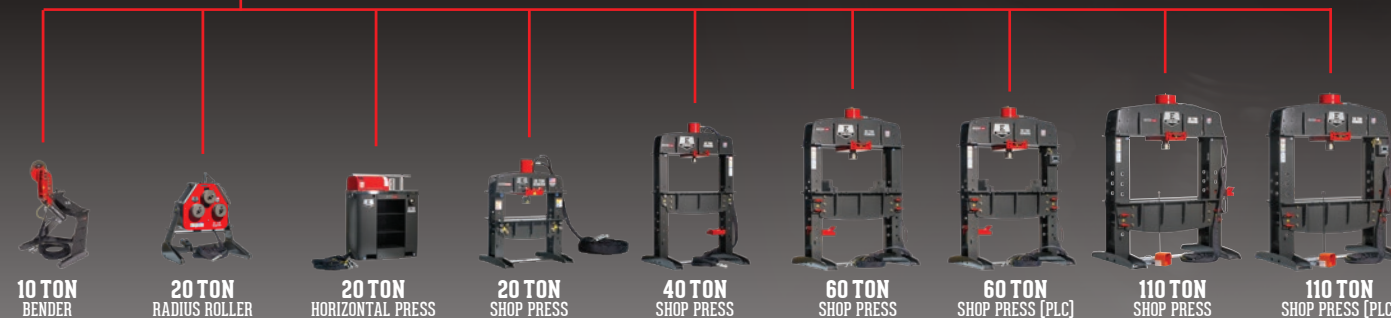

TURN THE PAGE TO VIEW OUR FULL LINE OF ATTACHMENTS & ACCESSORIES FOR THE 100 TON IRONWORKER



100 TON ATTACHMENTS



STANDARD PUNCH ASSEMBLY

- Accommodates punch & dies sets from 1/8" to 1-1/16" diameter
- Can be used as a secondary Punch Workstation on any Edwards Ironworker with an Open Workstation

AC1023-3*



OVERSIZE PUNCH ASSEMBLY

- Accommodates punch & die sets in various shapes and sizes from 1" up to 1-9/16"
- Replaces Standard Punch Assembly or can be used as a secondary Punch Workstation

AC1024*



241 PUNCH ASSEMBLY

- Accommodates punch & die sets in various shapes and sizes from 1" up to 4"
- Punch large holes and slots in anything from heavy sheet metal to steel beams

AC1055-2*



ANGLE NOTCHER

- Take precise 92° notch out of mild steel up to 3" x 3" x 1/4"
- Allows for an easy 90° to create a steel frame

AC10125*



COPER NOTCHER

- Versatile Attachment that removes anything from a small nibble to a large notch out of Flat Bar or Angle Iron
- Integrated alignment slots on the safety guarding easily allow for 45° shearing

AC1098*



PIPE NOTCHER HOUSING

- Make clean 90° saddle joint connections quickly and easily
- Compatible with all Edwards Ironworkers
- Contact Edwards for custom dies to match your project
- Pipe Notcher Dies sold separately

AC0925*



TURRET PIPE NOTCHER

- Make clean 90° saddle joint connections quickly and easily
- Compatible with all Edwards Ironworkers
- Contact Edwards for custom dies to match your project
- Pipe Notcher Dies sold separately

AC0925T*



MULTI SHEAR

- Designed to shear flat bar up to 1/4" x 6" and angle iron up to 2" x 2" x 1/4"
- Shears solid round bar 1/4", 3/8", 1/2", 3/4" and 13/16" square bar

AC1075*



ROD SHEAR

- Shear solid round rod easily with the Rod Shear
- Handles 1/4", 3/8", 1/2", 5/8", 3/4" and 1" solid round bar

AC1074*



BRAKE WITH 4-WAY DIE

- Choose from the sizes listed below to meet your specific needs
- Fabricate brackets, frames, pans and tanks with this Brake with 4-Way Die
- Includes a standard punch that allows 1/16", 1/8", 3/16" and 1/4" material to be formed to a 90° angle

7"	8"	10"	12"
AC1033*	AC1034*	AC1051*	AC1035*

100 TON ACCESSORIES



GAUGING TABLE KIT

- 3/8" thick, 12" x 16" table that adds precision to your Punch Workstation
- Compatible with both Standard and Oversize Pedestal Die Tables
- Adjustable fences and handles quickly and easily guide your material for perfect repeatable actions

AC0900



HEAVY DUTY GAUGING TABLE KIT

- 1" x 12" x 16" table adds speed and precision to your Punch Workstation
- Replaces Standard Pedestal Die Table
- Adjustable fences and handles quickly and easily guide your material for perfect repeatable actions

AC0903



HEAVY DUTY GAUGING TABLE KIT FOR OVERSIZED PUNCH ASSEMBLY

- 1" x 12" x 16" table adds speed and precision to your Punch Workstation
- Replaces installed Die Table
- Adjustable fences and handles quickly and easily guide your material for perfect repeatable actions

AC0905



COPER NOTCHER GAUGING TABLE KIT

- Provides a larger 3/8" x 12-1/2" x 15-5/8" size table and two fences to better align your material

AC0800



STRIPPER REDUCING PLATE

- Designed to minimize distortion on thinner gauge materials when using 1/2" punches & dies set or smaller

AC1914-4



URETHANE STRIPPER

- Minimize material distortion when working with light gauge material

AC1099



QUICK CHANGE PUNCH ASSEMBLY

- Accommodates punch and increase your efficiency by saving time and money with the Quick Change Punch Assembly.
- Accepts both Standard and Oversize Punch & Die Sets

AC1001



AUTO CUT - 48"

- Optimize your productivity on both the Flat Bar Shear and Angle Shear Workstations on your Edwards Ironworker
- The adjustable proximity sensor automatically cycles your Ironworker as you feed in material

AC1010



BACK GAUGE - 48"

- Speed up production on repeatable cuts by providing an adjustable stop for the Flat Bar Shear and Angle Shear
- A positive stop attachment that is fitted to the back of the Ironworker ensures accurate shearing

AC1011



PRESS BRAKE BACK GAUGE

- Speed up production on repeatable bends by providing an adjustable stop for the various size Brake Attachments
- A positive stop attachment that is fitted to the back of the Ironworker ensures accurate bending

PR135



PUNCH & DIE STARTER SET

- Includes 8 standard round punch & die sets selected to accommodate the most commonly used bolts
- Sized in 1/8" increments from 3/16" to 1-1/16" with 1/32" clearance
- See catalog page 68-71 for additional Punch & Die Sets

PD1000



ACCESSORY LIGHT

- Super bright LED light with M12 connections plugs
- Powerful magnetic base allows users to attach the light to any Ironworker surface and move as needed

AC1000



FABRICATOR'S PROTRACTOR

- Increase user accuracy on the Punch and Flat Bar Shear Workstations
- Designed to guide your workpiece and gauged at 15° increments through 180°

AC1017



12" & 18" FENCES GUIDES

- Easily adjustable to align your material, these 12" or 18" fence guides make precise, repeatable operations simple.

AC1910 12" Standard Handles
AC1911 18" Standard Handles
AC1912 12" Heavy Duty Handles
AC1913 18" Heavy Duty Handles



PRODUCTIVITY PACK

- Includes 5 Accessories designed to increase your accuracy and production speed.
- Accessory light
- 48" Auto Cut
- Fabricator's Protractor
- 3/8" x 12" x 16" Punch Station table
- Punch & Die Starter Kit

AC2000

*IMAGE NOTE: Guarding removed for clarity

*IMAGE NOTE: Guarding removed for clarity



100 TON DELUXE

100 TON DELUXE WITH **POWER LINK**



FLEXIBILITY

- **Five workstations:**
 - **Standard (4)** - Punch, Flat Bar Shear, Angle Shear & Coper Notcher, & Rod Shear
- 10 interchangeable Attachments available to tailor the Ironworker to your needs
- 16 optional Accessories available to increase precision and efficiency



PRODUCTIVITY

- Compact machine that allows for fast and easy transitions between fabrication operations: punch, shear, notch, bend and cope all in one machine.
- Optimized workstation heights for improved efficiency
- Electric foot pedal with integrated jog control
- Adjustable electric stroke control

SAFETY

- Bright LED lights increase visibility
- ANSI B11.5-1988(02) Compliant Guarding
- ETL Certified Controls
- Integrated Lock-out/Tag-out system with E-Stop for added safety

PERFORMANCE

- Durable, heavy-duty, Made In USA steel construction
- Vertical movement produces even pressure resulting in precise punching and shearing with minimal distortion that results in extended tooling life
- Punches are easily changeable, long-lasting and available from 1/8" to 4" diameters along with square, oblong, hex, metric, and custom shapes
- Flat Bar Shear blades are made of precision machined, high-quality tool steel with 4 cutting edges for extended life
- Angle Shear blades have 2 corner radii for both thin and thick material and are made of precision tool steel with 2 cutting edges for extended life

SPECIFICATIONS

Punch Rating (tons)	100
Punch Max Capacity (In.)	1-1/16 diam. In 1 mild steel
Punch Work Height (In.)	39-3/8
Punch Throat Depth (In.)	11
Punch Stroke (In.)	1-15/16
Flat Bar Shear Max Capacity (In.)	1/2 x 18 3/4 x 14 1 x 10
Flat Bar Shear Work Height (In.)	37
Flat Bar Shear Max Round Capacity (In.)	1 diam.
Flat Bar Shear Max Square Capacity (In.)	1
Angle Shear Max Capacity (In.)	6 x 6 x 1/2
Angle Shear Work Height (In.)	43-15/16
Coper Notcher Max Capacity (In.)	3 x 6 x 1/2
Coper Notcher Work Height (In.)	42
Rod Shear Max Round (In.)	1-1/2
Rod Shear Max Square (In.)	1-1/4
Rod Shear Work Height (In.)	54-1/2
Motor	10 HP
Amps	40
Hydraulics (GPM)	24
Hydraulics (PSI)	3800
Hydraulic Reservoir (gal.)	17
Product Dimensions (In.)	56 x 45-1/2 x 63-1/8
Shipping Dimensions (In.)	60 x 67 x 69
Weight (lbs.)	5,180

STOCK #	PRODUCT DESCRIPTION
IW100DX-1P230	100 Ton Deluxe Ironworker 1 Phase, 230 Volt
IW100DX-3P208	100 Ton Deluxe Ironworker 3 Phase, 208 Volt
IW100DX-3P230	100 Ton Deluxe Ironworker 3 Phase, 230 Volt
IW100DX-3P380	100 Ton Deluxe Ironworker Int'l - 3 Phase, 380 Volt, 50 Hz
IW100DX-3P460	100 Ton Deluxe Ironworker 3 Phase, 460 Volt
IW100DX-3P575	100 Ton Deluxe Ironworker 3 Phase, 575 Volt



THE EXCLUSIVE EDWARDS POWERLINK™ SYSTEM TURNS YOUR 100 TON DELUXE IRONWORKER INTO A POWER SOURCE FOR OUR EVER INCREASING LINE OF HYDRAULIC TOOLS.

- Simply PLUG IN & POWER UP any of our Hydraulic Tools and expand your fabrication capabilities
- Our factory installed PowerLink System includes quick connect couplings allowing easy transitions between Hydraulic Tools
- The Edwards Portable Power Unit is an additional power source with the PowerLink System

POWER LINK

STOCK #	PRODUCT DESCRIPTION
IW100DX-1P230-AC	100 Ton Deluxe Ironworker 1 Phase, 230 Volt with PowerLink
IW100DX-3P208-AC	100 Ton Deluxe Ironworker 3 Phase, 208 Volt with PowerLink
IW100DX-3P230-AC	100 Ton Deluxe Ironworker 3 Phase, 230 Volt with PowerLink
IW100DX-3P380-AC	100 Ton Deluxe Ironworker Int'l - 3 Phase, 380 Volt, 50 Hz with PowerLink
IW100DX-3P460-AC	100 Ton Deluxe Ironworker 3 Phase, 460 Volt with PowerLink
IW100DX-3P575-AC	100 Ton Deluxe Ironworker 3 Phase, 575 Volt with PowerLink

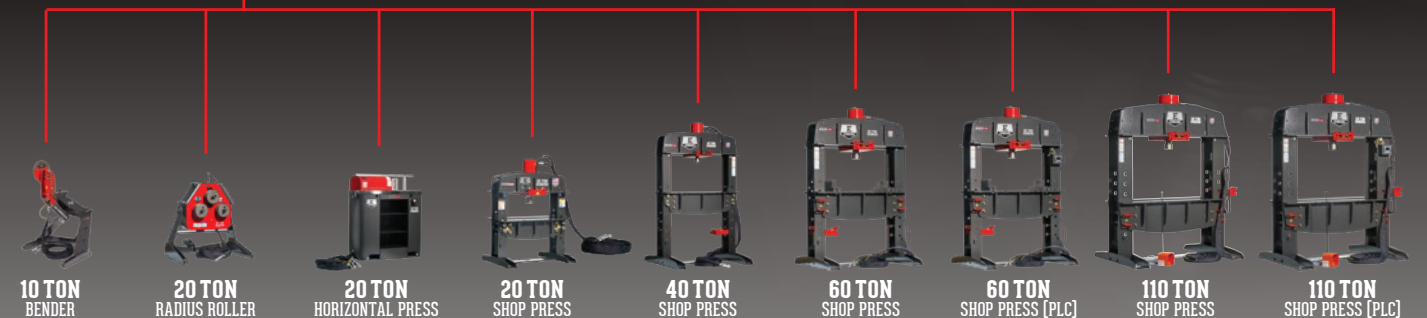

TURN THE PAGE TO VIEW OUR FULL LINE OF ATTACHMENTS & ACCESSORIES FOR THE 100 TON DELUXE IRONWORKER



100 TON DELUXE ATTACHMENTS

100 TON DELUXE ACCESSORIES



OVERSIZE PUNCH ASSEMBLY

- Accommodates punch & die sets in various shapes and sizes from 1" up to 1-9/16"
- Replaces Standard Punch Assembly or can be used as a secondary Punch Workstation

AC1026*



241 PUNCH ASSEMBLY

- Accommodates punch & die sets in various shapes and sizes from 1" up to 4"
- Punch large holes and slots in anything from heavy sheet metal to steel beams

AC1055-3*



ANGLE NOTCHER

- Take precise 92° notch out of mild steel up to 3" x 3" x 1/4"
- Allows for an easy 90° to create a steel frame

AC0126*



PIPE NOTCHER HOUSING

- Make clean 90° saddle joint connections quickly and easily
- Compatible with all Edwards Ironworkers
- Contact Edwards for custom dies to match your project
- Pipe Notcher Dies sold separately

AC0925*



TURRET PIPE NOTCHER

- Make clean 90° saddle joint connections quickly and easily
- Compatible with all Edwards Ironworkers
- Contact Edwards for custom dies to match your project
- Pipe Notcher Dies sold separately

AC0925T*



MULTI SHEAR

- Designed to shear flat bar up to 1/4" x 6" and angle iron up to 2" x 2" x 1/4"
- Shears solid round bar 1/4", 3/8", 1/2", 3/4" and 13/16" square bar

AC1075*



ROD SHEAR

- Shear solid round rod easily with the Rod Shear
- Handles 1/4", 3/8", 1/2", 5/8", 3/4" and 1" solid round bar

AC1074*



BRAKE WITH 4-WAY DIE

- Choose from the sizes listed below to meet your specific needs
- Fabricate brackets, frames, pans and tanks with this Brake with 4-Way Die
- Includes a standard punch that allows 1/16", 1/8", 3/16" and 1/4" material to be formed to a 90° angle

7" AC1033*

8" AC1034*

10" AC1051*



HEAVY DUTY GAUGING TABLE KIT

- 1" x 12" x 16" table adds speed and precision to your Punch Workstation
- Replaces Standard Pedestal Die Table
- Adjustable fences and handles quickly and easily guide your material for perfect repeatable actions

AC0904



HEAVY DUTY GAUGING TABLE KIT FOR OVERSIZED PUNCH ASSEMBLY

- 1" x 12" x 16" table adds speed and precision to your Punch Workstation
- Replaces installed Die Table
- Adjustable fences and handles quickly and easily guide your material for perfect repeatable actions

AC0906



COPPER NOTCHER GAUGING TABLE KIT

- Provides a larger 3/8" x 12-1/2" x 15-5/8" size table and two fences to better align your material

AC0800



STRIPPER REDUCING PLATE

- Designed to minimize distortion on thinner gauge materials when using 1/2" punches & dies set or smaller

AC1914-6



URETHANE STRIPPER

- Minimize material distortion when working with light gauge material

AC1099



QUICK CHANGE PUNCH ASSEMBLY

- Accommodates punch and increase your efficiency by saving time and money with the Quick Change Punch Assembly.
- Accepts both Standard and Oversize Punch & Die Sets

AC1001



AUTO CUT - 48"

- Optimize your productivity on both the Flat Bar Shear and Angle Shear Workstations on your Edwards Ironworker
- The adjustable proximity sensor automatically cycles your Ironworker as you feed in material

AC1010



BACK GAUGE - 48"

- Speed up production on repeatable cuts by providing an adjustable stop for the Flat Bar Shear and Angle Shear
- A positive stop attachment that is fitted to the back of the Ironworker ensures accurate shearing

AC1011



PRESS BRAKE BACK GAUGE

- Speed up production on repeatable bends by providing an adjustable stop for the various size Brake Attachments
- A positive stop attachment that is fitted to the back of the Ironworker ensures accurate bending

PR135



PUNCH & DIE STARTER SET

- Includes 8 standard round punch & die sets selected to accommodate the most commonly used bolts
- Sized in 1/8" increments from 3/16" to 1-1/16" with 1/32" clearance
- See catalog page 68-71 for additional Punch & Die Sets

PD1000



ACCESSORY LIGHT

- Super bright LED light with M12 connections plugs
- Powerful magnetic base allows users to attach the light to any Ironworker surface and move as needed

AC1000



FABRICATOR'S PROTRACTOR

- Increase user accuracy on the Punch and Flat Bar Shear Workstations
- Designed to guide your workpiece and gauged at 15° increments through 180°

AC1017



12" & 18" FENCES GUIDES

- Easily adjustable to align your material, these 12" or 18" fence guides make precise, repeatable operations simple.

AC1910 12" Standard Handles
AC1911 18" Standard Handles
AC1912 12" Heavy Duty Handles
AC1913 18" Heavy Duty Handles



PRODUCTIVITY PACK

- Includes 5 Accessories designed to increase your accuracy and production speed.
- Accessory light
- 48" Auto Cut
- Fabricator's Protractor
- 3/8" x 12" x 16" Punch Station table
- Punch & Die Starter Kit

AC3000

*IMAGE NOTE: Guarding removed for clarity

*IMAGE NOTE: Guarding removed for clarity



120 TON

120 TON



FLEXIBILITY

- **Five workstations:**
 - **Standard (4)** - Punch, Flat Bar Shear, Angle Shear & Coper Notcher
 - **Open (1)** - Customize your Ironworker with 4 optional Attachments - Brake, Rod Shear, Multi-Shear or Pipe Notcher
- 12 interchangeable Attachments available to tailor the Ironworker to your needs
- 15 optional Accessories available to increase precision and efficiency



PRODUCTIVITY

- Compact machine that allows for fast and easy transitions between fabrication operations: punch, shear, notch, bend and cope all in one machine.
- Optimized workstation heights for improved efficiency
- Electric foot pedal with integrated jog control
- Adjustable electric stroke control

SAFETY

- Bright LED lights increase visibility
- ANSI B11.5-1988(O2) Compliant Guarding
- ETL Certified Controls
- Integrated Lock-out/Tag-out system with E-Stop for added safety

PERFORMANCE

- Durable, heavy-duty, Made In USA steel construction
- Vertical movement produces even pressure resulting in precise punching and shearing with minimal distortion that results in extended tooling life
- Punches are easily changeable, long-lasting and available from 1/8" to 4" diameters along with square, oblong, hex, metric, and custom shapes
- Flat Bar Shear blades are made of precision machined, high-quality tool steel with 4 cutting edges for extended life
- Angle Shear blades have 2 corner radii for both thin and thick material and are made of precision tool steel with 2 cutting edges for extended life

STOCK #	PRODUCT DESCRIPTION
IW120-1P230	120 Ton Ironworker 1 Phase, 230 Volt
IW120-3P208	120 Ton Ironworker 3 Phase, 208 Volt
IW120-3P230	120 Ton Ironworker 3 Phase, 230 Volt
IW120-3P380	120 Ton Ironworker Int'l - 3 Phase, 380 Volt, 50 Hz
IW120-3P460	120 Ton Ironworker 3 Phase, 460 Volt
IW120-3P575	120 Ton Ironworker 3 Phase, 575 Volt

SPECIFICATIONS

Punch Rating (tons)	120
Punch Max Capacity (in.)	1-1/2 diam. In 1 mild steel
Punch Work Height (in.)	36-5/8
Punch Throat Depth (in.)	11
Punch Stroke (in.)	2
Flat Bar Shear Max Capacity (in.)	1/2 x 24 1 x 12
Flat Bar Shear Work Height (in.)	33-1/4
Flat Bar Shear Max Round Capacity (in.)	1-1/4 diam.
Flat Bar Shear Max Square Capacity (in.)	1-1/4
Angle Shear Max Capacity (in.)	6 x 6 x 1/2
Angle Shear Work Height (in.)	52-1/2
Coper Notcher Max Capacity (In.)	3 x 6 x 1/2
Coper Notcher Work Height (In.)	40
Open Cavity Height (In.)	9
Open Cavity Width (In.)	11-3/4
Open Cavity Work Height (In.)	51-3/4
Motor	10 HP
Amps	40
Hydraulics (GPM)	24
Hydraulics (PSI)	3800
Hydraulic Reservoir (gal.)	17
Product Dimensions (In.)	60 x 60 x 84
Shipping Dimensions (In.)	60 x 67 x 87
Weight (lbs.)	5,975

THE EXCLUSIVE EDWARDS POWERLINK™ SYSTEM TURNS YOUR 120 TON IRONWORKER INTO A POWER SOURCE FOR OUR EVER INCREASING LINE OF HYDRAULIC TOOLS.

- Simply PLUG IN & POWER UP any of our Hydraulic Tools and expand your fabrication capabilities
- Our factory installed PowerLink System includes quick connect couplings allowing easy transitions between Hydraulic Tools
- The Edwards Portable Power Unit is an additional power source with the PowerLink System

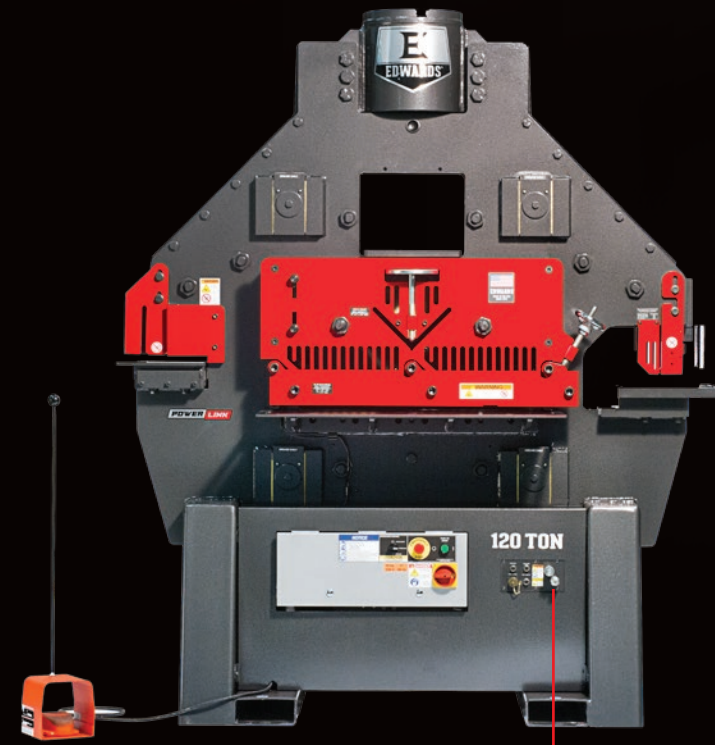

STOCK #	PRODUCT DESCRIPTION
IW120-1P230-AC900	120 Ton Ironworker 1 Phase, 230 Volt with PowerLink
IW120-3P208-AC900	120 Ton Ironworker 3 Phase, 208 Volt with PowerLink
IW120-3P230-AC900	120 Ton Ironworker 3 Phase, 230 Volt with PowerLink
IW120-3P380-AC900	120 Ton Ironworker Int'l - 3 Phase, 380 Volt, 50 Hz with PowerLink
IW120-3P460-AC900	120 Ton Ironworker 3 Phase, 460 Volt with PowerLink
IW120-3P575-AC900	120 Ton Ironworker 3 Phase, 575 Volt with PowerLink



10 TON BENDER

20 TON RADIUS ROLLER

20 TON HORIZONTAL PRESS

20 TON SHOP PRESS

40 TON SHOP PRESS

60 TON SHOP PRESS

60 TON SHOP PRESS (PLC)

110 TON SHOP PRESS

110 TON SHOP PRESS (PLC)

TURN THE PAGE TO VIEW OUR FULL LINE OF ATTACHMENTS & ACCESSORIES FOR THE 120 TON IRONWORKER



120 TON ATTACHMENTS



OVERSIZE PUNCH ASSEMBLY

- Accommodates punch & die sets in various shapes and sizes from 1" up to 1-9/16"
- Replaces Standard Punch Assembly or can be used as a secondary Punch Workstation

AC1026*



241 PUNCH ASSEMBLY

- Accommodates punch & die sets in various shapes and sizes from 1" up to 4"
- Punch large holes and slots in anything from heavy sheet metal to steel beams

AC1055-4*



ANGLE NOTCHER

- Take precise 92° notch out of mild steel up to 3" x 3" x 1/4"
- Allows for an easy 90° to create a steel frame

AC1026*



PIPE NOTCHER HOUSING

- Make clean 90° saddle joint connections quickly and easily
- Compatible with all Edwards Ironworkers
- Contact Edwards for custom dies to match your project
- Pipe Notcher Dies sold separately

AC0925*

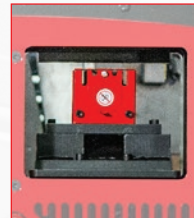

PIPE NOTCHER HOUSING FOR OPEN CAVITY

- Make clean 90° saddle joint connections quickly and easily
- Compatible with the 65,120, and 110/65 Ton Elite Ironworkers
- Contact Edwards for custom dies to match your project
- Pipe Notcher Dies sold separately

AC0925C**



TURRET PIPE NOTCHER

- Make clean 90° saddle joint connections quickly and easily
- Compatible with all Edwards Ironworkers
- Contact Edwards for custom dies to match your project
- Pipe Notcher Dies sold separately

AC0925T*



MULTI SHEAR

- Designed to shear flat bar up to 1/4" x 6" and angle iron up to 2" x 2" x 1/4"
- Shears solid round bar 1/4", 3/8", 1/2", 3/4" and 13/16" square bar

AC1075*



ROD SHEAR

- Shear solid round rod easily with the Rod Shear
- Handles 1/4", 3/8", 1/2", 5/8", 3/4" and 1" solid round bar

AC1074*



BRAKE WITH 4-WAY DIE

- Choose from the sizes listed below to meet your specific needs
- Fabricate brackets, frames, pans and tanks with this Brake with 4-Way Die
- Includes a standard punch that allows 1/16", 1/8", 3/16" and 1/4" material to be formed to a 90° angle

7"	8"	10"	10" OPEN CAVITY
AC1033*	AC1034*	AC1051*	AC1052*

120 TON ACCESSORIES



HEAVY DUTY GAUGING TABLE KIT

- 1" x 12" x 16" table adds speed and precision to your Punch Workstation
- Replaces Standard Pedestal Die Table
- Adjustable fences and handles quickly and easily guide your material for perfect repeatable actions

AC0904



HEAVY DUTY GAUGING TABLE KIT FOR OVERSIZED PUNCH ASSEMBLY

- 1" x 12" x 16" table adds speed and precision to your Punch Workstation
- Replaces installed Die Table
- Adjustable fences and handles quickly and easily guide your material for perfect repeatable actions

AC0906



STRIPPER REDUCING PLATE

- Designed to minimize distortion on thinner gauge materials when using 1/2" punches & dies set or smaller

AC1914-7



URETHANE STRIPPER

- Minimize material distortion when working with light gauge material

AC1099



QUICK CHANGE PUNCH ASSEMBLY

- Accommodates punch and increase your efficiency by saving time and money with the Quick Change Punch Assembly.
- Accepts both Standard and Oversize Punch & Die Sets

AC1001



AUTO CUT - 48"

- Optimize your productivity on both the Flat Bar Shear and Angle Shear Workstations on your Edwards Ironworker
- The adjustable proximity sensor automatically cycles your Ironworker as you feed in material

AC1010



BACK GAUGE - 48"

- Speed up production on repeatable cuts by providing an adjustable stop for the Flat Bar Shear and Angle Shear
- A positive stop attachment that is fitted to the back of the Ironworker ensures accurate shearing

AC1011



PRESS BRAKE BACK GAUGE

- Speed up production on repeatable bends by providing an adjustable stop for the various size Brake Attachments
- A positive stop attachment that is fitted to the back of the Ironworker ensures accurate bending

PR135



PUNCH & DIE STARTER SET

- Includes 8 standard round punch & die sets selected to accommodate the most commonly used bolts
- Sized in 1/8" increments from 3/16" to 1-1/16" with 1/32" clearance
- See catalog page 68-71 for additional Punch & Die Sets

PD1000



ACCESSORY LIGHT

- Super bright LED light with M12 connections plugs
- Powerful magnetic base allows users to attach the light to any Ironworker surface and move as needed

AC1000



FABRICATOR'S PROTRACTOR

- Increase user accuracy on the Punch and Flat Bar Shear Workstations
- Designed to guide your workpiece and gauged at 15° increments through 180°

AC1017



12" & 18" FENCES GUIDES

- Easily adjustable to align your material, these 12" or 18" fence guides make precise, repeatable operations simple.

AC1910 12" Standard Handles
AC1911 18" Standard Handles
AC1912 12" Heavy Duty Handles
AC1913 18" Heavy Duty Handles



PRODUCTIVITY PACK

- Includes 5 Accessories designed to increase your accuracy and production speed.
- Accessory light
- 48" Auto Cut
- Fabricator's Protractor
- 3/8" x 12" x 16" Punch Station table
- Punch & Die Starter Kit

AC3000

*IMAGE NOTE: Guarding removed for clarity

*IMAGE NOTE: Guarding removed for clarity



ELITE 110 TON



FLEXIBILITY

- **Four Workstations:**
 - **Standard (3)** — Punch, Flat Bar Shear & Angle Shear
 - **Open (1)** — Customize your Ironworker with optional Attachments
- 13 interchangeable Attachments available to tailor the Ironworker to your needs
- 14 optional Accessories available to increase precision and efficiency



PRODUCTIVITY

- Standard PowerLink™ System increases your capabilities by turning your Ironworker into a power source for our ever expanding line of Hydraulic Tools
- Compact machine that allows for fast and easy transitions between fabrication operations: punch, shear, notch, bend and cope all in one machine
- Hydraulic Hold Down automatically secures your material in place preventing movement for quick and clean shearing on both Flat Bar & Angle Shears

SAFETY

- Bright LED lights increase visibility
- ANSI B11.5-1988(O2) Compliant Guarding
- ETL Certified Controls
- Integrated Lock-out/Tag-out system with multiple location E-Stops for added safety

PERFORMANCE

- Durable, heavy-duty, Made In USA steel construction
- Vertical movement produces even pressure resulting in precise punching and shearing with minimal distortion that results in extended tooling life
- Central Lubrication System simplifies Ironworker maintenance
- Punches are easily changeable, long-lasting and available from 1/8" to 4" diameters along with square, oblong, hex, metric, and custom shapes

SPECIFICATIONS	
Punch Rating (tons)	110
Punch Max Capacity (in.)	1-3/8 diam. in 1 mild steel
Punch Work Height (in.)	41
Punch Throat Depth (in.)	11-3/4
Punch Stroke (in.)	1-13/16
Flat Bar Shear Max Capacity (in.)	3/4 x 14 1 x 12
Flat Bar Shear Work Height (in.)	41-1/2
Flat Bar Shear Max Round Capacity (in.)	1-1/4 diam.
Flat Bar Shear Max Square Capacity (in.)	1-1/4
Angle Shear Max Capacity (in.)	6 x 6 x 1/2
Angle Shear Work Height (in.)	50-7/8
Open Workstation Work Height (in.)	39-3/16
Open Workstation Throat Depth (in.)	15-1/2
Opt. Coper Notcher Max Capacity (in.)	2-1/2 x 6 x 1/2
Opt. Coper Notcher Work Height (in.)	44-3/16
Standard Motor	7.5 HP
Hydraulics	10-1/2 GPM & 3000 PSI
Amps	36
Hydraulic Reservoir (gal.)	17
Dimensions (in.)	57-1/4 x 42-3/8 x 66-1/16
Weight (lbs.)	5,380

STOCK #	PRODUCT DESCRIPTION
ELT110-1P230	110 Ton Elite Ironworker 1 Ph, 230 V
ELT110-3P208	110 Ton Elite Ironworker 3 Ph, 208 V
ELT110-3P230	110 Ton Elite Ironworker 3 Ph, 230 V
ELT110-3P380	110 Ton Elite Ironworker Int'l - 3 Phase, 380 Volt, 50 Hz
ELT110-3P460	110 Ton Elite Ironworker 3 Ph, 460 V
ELT110-3P575	110 Ton Elite Ironworker 3 Ph, 575 V

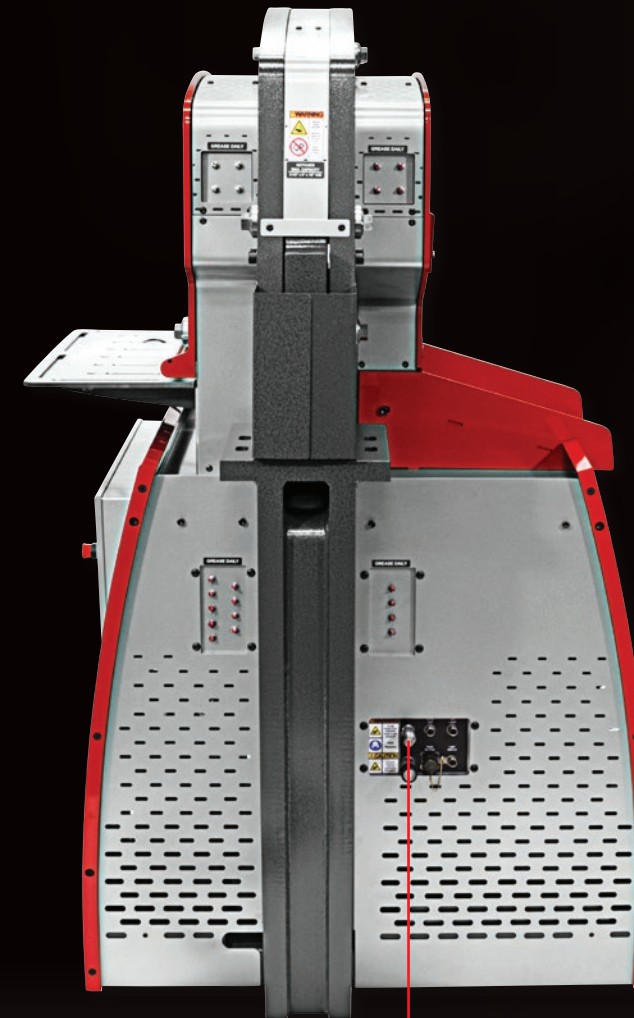

STANDARD POWERLINK™ SYSTEM INCREASES YOUR CAPABILITIES BY TURNING YOUR IRONWORKER INTO A POWER SOURCE FOR OUR EVER EXPANDING LINE OF HYDRAULIC TOOLS

- Simply PLUG IN & POWER UP any of our Hydraulic Tools and expand your fabrication capabilities
- Our factory installed PowerLink System includes quick connect couplings allowing easy transitions between Hydraulic Tools
- The EDWARDS Portable Power Unit is an additional power source with the PowerLink System



TURN THE PAGE TO VIEW OUR FULL LINE OF ATTACHMENTS & ACCESSORIES FOR THE ELITE 110 TON IRONWORKER



ELITE 110 TON ATTACHMENTS

ELITE 110 TON ACCESSORIES



STANDARD PUNCH ASSEMBLY

- Accommodates punch & die sets from 1/8" to 1-1/16" diameter
- Can be used as a secondary Punch Workstation on any Edwards Ironworker with an Open Workstation

AC1023-4*



OVERSIZE PUNCH ASSEMBLY

- Accommodates punch & die sets in various shapes and sizes from 1" up to 1-9/16"
- Replaces Standard Punch Assembly or can be used as a secondary Punch Workstation

AC1024*



241 PUNCH ASSEMBLY

- Accommodates punch & die sets in various shapes and sizes from 1" up to 4"
- Punch large holes and slots in anything from heavy sheet metal to steel beams

AC1055-5*



ANGLE NOTCHER

- Take precise 92° notch out of mild steel up to 3" x 3" x 1/4"
- Allows for an easy 90° to create a steel frame

AC10125*



COPER NOTCHER

- Versatile Attachment that removes anything from a small nibble to a large notch out of Flat Bar or Angle Iron
- Integrated alignment slots on the safety guarding easily allow for 45° shearing

AC1097*



PIPE NOTCHER HOUSING

- Make clean 90° saddle joint connections quickly and easily
- Compatible with all Edwards Ironworkers
- Contact Edwards for custom dies to match your project
- Pipe Notcher Dies sold separately

AC0925*



TURRET PIPE NOTCHER

- Make clean 90° saddle joint connections quickly and easily
- Compatible with all Edwards Ironworkers
- Contact Edwards for custom dies to match your project
- Pipe Notcher Dies sold separately

AC0925T*



MULTI SHEAR

- Designed to shear flat bar up to 1/4" x 6" and angle iron up to 2" x 2" x 1/4"
- Shears solid round bar 1/4", 3/8", 1/2", 3/4" and 13/16" square bar

AC1075*



ROD SHEAR

- Shear solid round rod easily with the Rod Shear
- Handles 1/4", 3/8", 1/2", 5/8", 3/4" and 1" solid round bar

AC1074*



BRAKE WITH 4-WAY DIE

- Fabricate brackets, frames, pans and tanks with this Brake with 4-Way Die
- Includes a standard punch that allows 1/16", 1/8", 3/16" and 1/4" material to be formed to a 90° angle

7"	8"	10"	12"
AC1033*	AC1034*	AC1051*	AC1035*



HEAVY DUTY GAUGING TABLE KIT

- 1" x 12" x 16" table adds speed and precision to your Punch Workstation
- Replaces Standard Pedestal Die Table
- Adjustable fences and handles quickly and easily guide your material for perfect repeatable actions

AC0903



HEAVY DUTY GAUGING TABLE KIT FOR OVERSIZED PUNCH ASSEMBLY

- 1" x 12" x 16" table adds speed and precision to your Punch Workstation
- Replaces installed Die Table
- Adjustable fences and handles quickly and easily guide your material for perfect repeatable actions

AC0905



URETHANE STRIPPER

- Minimize material distortion when working with light gauge material

AC1099



QUICK CHANGE PUNCH ASSEMBLY

- Accommodates punch and increase your efficiency by saving time and money with your Edwards Ironworker
- Accepts both Standard and Oversize Punch & Die Sets

AC1001



AUTO CUT - 48"

- Optimize your productivity on both the Flat Bar Shear and Angle Shear Workstations on your Edwards Ironworker
- The adjustable proximity sensor automatically cycles your Ironworker as you feed in material

AC1010



BACK GAUGE - 48"

- Speed up production on repeatable cuts by providing an adjustable stop for the Flat Bar Shear and Angle Shear
- A positive stop attachment that is fitted to the back of the Ironworker ensures accurate shearing

AC1011



PRESS BRAKE BACK GAUGE

- Speed up production on repeatable bends by providing an adjustable stop for the various size Brake Attachments
- A positive stop attachment that is fitted to the back of the Ironworker ensures accurate bending

PR135



PUNCH & DIE STARTER SET

- Includes 8 standard round punch & die sets selected to accommodate the most commonly used bolts
- Sized in 1/8" increments from 3/16" to 1-1/16" with 1/32" clearance
- See catalog page 68-71 for additional Punch & Die Sets

PD1000



ACCESSORY LIGHT

- Super bright LED light with M12 connections plugs
- Powerful magnetic base allows users to attach the light to any Ironworker surface and move as needed

AC1000



FABRICATOR'S PROTRACTOR

- Increase user accuracy on the Punch and Flat Bar Shear Workstations
- Designed to guide your workpiece and gauged at 15° increments through 180°

AC1017



12" & 18" FENCES GUIDES

- Easily adjustable to align your material, these 12" or 18" fence guides make precise, repeatable operations simple.

AC1910 12" Standard Handles
AC1911 18" Standard Handles
AC1912 12" Heavy Duty Handles
AC1913 18" Heavy Duty Handles

*IMAGE NOTE: Guarding removed for clarity

*IMAGE NOTE: Guarding removed for clarity



ELITE 110/65 TON



FLEXIBILITY

- **Five Workstations:**
 - **Standard (4)** — Punch, Flat Bar Shear, Angle Shear & Coper Notcher
 - **Open (1)** — Customize your Ironworker with optional Attachments
- 12 interchangeable Attachments available to tailor the Ironworker to your needs
- 14 optional Accessories available to increase precision and efficiency



PRODUCTIVITY

- Standard PowerLink™ System increases your capabilities by turning your Ironworker into a power source for our ever expanding line of Hydraulic Tools
- Compact machine that allows for fast and easy transitions between fabrication operations: punch, shear, notch, bend and cope all in one machine
- Two independent power plants produce true Dual Operation
- Hydraulic Hold Down automatically secures your material in place preventing movement for quick and clean shearing on both Flat Bar & Angle Shears

SAFETY

- Adjustable electric stoke control
- Bright LED lights increase visibility
- ANSI B11.5-1988(02) Compliant Guarding
- ETL Certified Controls
- Integrated Lock-out/Tag-out system with multiple location E-Stops for added safety

PERFORMANCE

- Durable, heavy-duty Made In USA steel construction
- Vertical movement produces even pressure resulting in precise punching and shearing with minimal distortion that results in extended tooling life
- Central Lubrication System simplifies Ironworker maintenance

STOCK #	PRODUCT DESCRIPTION
ELT11065-1P230	110/65 Ton Elite Dual Operator Ironworker 1 Ph, 230 V
ELT11065-3P208	110/65 Ton Elite Dual Operator Ironworker 3 Ph, 208 V
ELT11065-3P230	110/65 Ton Elite Dual Operator Ironworker 3 Ph, 230 V
ELT11065-3P380	110/65 Ton Elite Dual Operator Ironworker Int'l - 3 Phase, 380 Volt, 50 Hz
ELT11065-3P460	110/65 Ton Elite Dual Operator Ironworker 3 Phase, 460 V
ELT11065-3P575	110/65 Ton Elite Dual Operator Ironworker 3 P, 575 V

SPECIFICATIONS

Punch Rating (tons)	110/65
Punch Max Capacity (in.)	1-3/8 diam. in 1 mild steel
Punch Work Height (in.)	37-1/2
Punch Throat Depth (in.)	17-3/4
Punch Stroke (in.)	3
Flat Bar Shear Max Capacity (in.)	3/8 x 24 1/2 x 14 1 x 4
Flat Bar Shear Work Height (in.)	33-1/2
Flat Bar Shear Max Round Capacity (in.)	1 diam.
Flat Bar Shear Max Square Capacity (in.)	1
Angle Shear Max Capacity (in.)	5 x 5 x 3/8
Angle Shear Work Height (in.)	44
Coper Notcher Max Capacity (In.)	2-1/2 x 6 x 3/8
Coper Notcher Work Height (In.)	35-5/8
Open Cavity Height (In.)	9
Open Cavity Width (In.)	11-3/4
Open Cavity Work Height (In.)	40-7/8
Standard Motor	7.5 HP
Amps	36
Hydraulics (GPM)	10-1/2
Hydraulics (PSI)	3000
Hydraulic Reservoir (gal.)	17
Product Dimensions (In.)	44-7/8 x 97 x 65-1/8
Shipping Dimensions (In.)	48 x 96 x 72
Weight (lbs.)	8,680

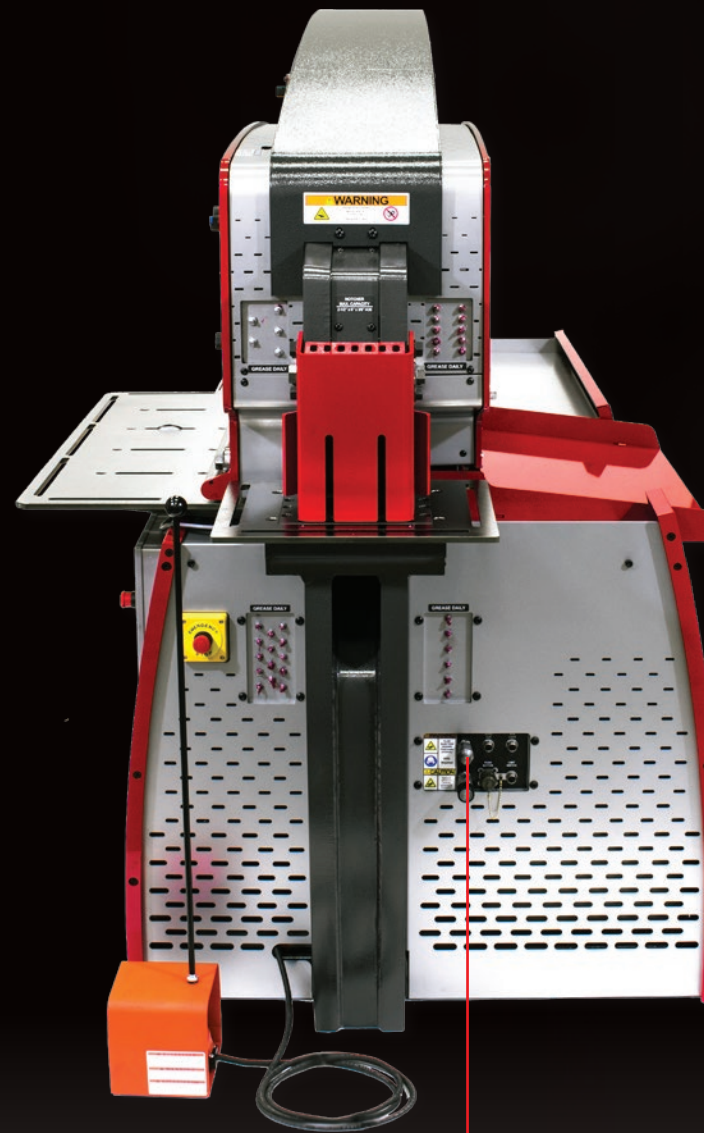

STANDARD POWERLINK™ SYSTEM INCREASES YOUR CAPABILITIES BY TURNING YOUR IRONWORKER INTO A POWER SOURCE FOR OUR EVER EXPANDING LINE OF HYDRAULIC TOOLS

- Simply PLUG IN & POWER UP any of our Hydraulic Tools and expand your fabrication capabilities
- Our factory installed PowerLink System includes quick connect couplings allowing easy transitions between Hydraulic Tools
- The EDWARDS Portable Power Unit is an additional power source with the PowerLink System



TURN THE PAGE TO VIEW OUR FULL LINE OF ATTACHMENTS & ACCESSORIES FOR THE ELITE 110/65 TON IRONWORKER



ELITE 110/65 TON ATTACHMENTS

ELITE 110/65 TON ACCESSORIES



OVERSIZE PUNCH ASSEMBLY

- Accommodates punch & die sets in various shapes and sizes from 1" up to 1-9/16"
- Replaces Standard Punch Assembly or can be used as a secondary Punch Workstation

AC1024*



241 PUNCH ASSEMBLY

- Accommodates punch & die sets in various shapes and sizes from 1" up to 4"
- Punch large holes and slots in anything from heavy sheet metal to steel beams

AC1055-6*



ANGLE NOTCHER

- Take precise 92° notch out of mild steel up to 3" x 3" x 1/4"
- Allows for an easy 90° to create a steel frame

AC1025*



PIPE NOTCHER HOUSING

- Make clean 90° saddle joint connections quickly and easily
- Compatible with all Edwards Ironworkers
- Contact Edwards for custom dies to match your project
- Pipe Notcher Dies sold separately

AC0925*

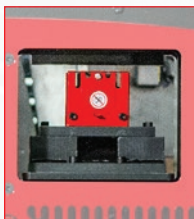

PIPE NOTCHER HOUSING FOR OPEN CAVITY

- Make clean 90° saddle joint connections quickly and easily
- Compatible with the 65,120, and 110/65 Ton Elite Ironworkers
- Contact Edwards for custom dies to match your project
- Pipe Notcher Dies sold separately

AC0925C**



TURRET PIPE NOTCHER

- Make clean 90° saddle joint connections quickly and easily
- Compatible with all Edwards Ironworkers
- Contact Edwards for custom dies to match your project
- Pipe Notcher Dies sold separately

AC0925T*



MULTI SHEAR

- Designed to shear flat bar up to 1/4" x 6" and angle iron up to 2" x 2" x 1/4"
- Shears solid round bar 1/4", 3/8", 1/2", 3/4" and 13/16" square bar

AC1075*



ROD SHEAR

- Shear solid round rod easily with the Rod Shear
- Handles 1/4", 3/8", 1/2", 5/8", 3/4" and 1" solid round bar

AC1074*



BRAKE WITH 4-WAY DIE

- Choose from the sizes listed below to meet your specific needs
- Fabricate brackets, frames, pans and tanks with this Brake with 4-Way Die
- Includes a standard punch that allows 1/16", 1/8", 3/16" and 1/4" material to be formed to a 90° angle

7"	8"	10"	10" OPEN CAVITY	12"
AC1033*	AC1034*	AC1051*	AC1052*	AC1035*



HEAVY DUTY GAUGING TABLE KIT

- 1" x 12" x 16" table adds speed and precision to your Punch Workstation
- Replaces Standard Pedestal Die Table
- Adjustable fences and handles quickly and easily guide your material for perfect repeatable actions

AC0903



HEAVY DUTY GAUGING TABLE KIT FOR OVERSIZED PUNCH ASSEMBLY

- 1" x 12" x 16" table adds speed and precision to your Punch Workstation
- Replaces installed Die Table
- Adjustable fences and handles quickly and easily guide your material for perfect repeatable actions

AC0905



URETHANE STRIPPER

- Minimize material distortion when working with light gauge material

AC1099



QUICK CHANGE PUNCH ASSEMBLY

- Accommodates punch and increase your efficiency by saving time and money with the Quick Change Punch Assembly.
- Accepts both Standard and Oversize Punch & Die Sets

AC1001



AUTO CUT - 48"

- Optimize your productivity on both the Flat Bar Shear and Angle Shear Workstations on your Edwards Ironworker
- The adjustable proximity sensor automatically cycles your Ironworker as you feed in material

AC1010



BACK GAUGE - 48"

- Speed up production on repeatable cuts by providing an adjustable stop for the Flat Bar Shear and Angle Shear
- A positive stop attachment that is fitted to the back of the Ironworker ensures accurate shearing

AC1011

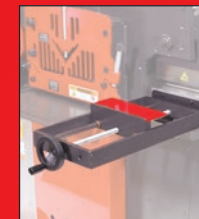

PRESS BRAKE BACK GAUGE

- Speed up production on repeatable bends by providing an adjustable stop for the various size Brake Attachments
- A positive stop attachment that is fitted to the back of the Ironworker ensures accurate bending

PR135



PUNCH & DIE STARTER SET

- Includes 8 standard round punch & die sets selected to accommodate the most commonly used bolts
- Sized in 1/8" increments from 3/16" to 1-1/16" with 1/32" clearance
- See catalog page 68-71 for additional Punch & Die Sets

PD1000



ACCESSORY LIGHT

- Super bright LED light with M12 connections plugs
- Powerful magnetic base allows users to attach the light to any Ironworker surface and move as needed

AC1000



FABRICATOR'S PROTRACTOR

- Increase user accuracy on the Punch and Flat Bar Shear Workstations
- Designed to guide your workpiece and gauged at 15° increments through 180°

AC1017



12" & 18" FENCES GUIDES

- Easily adjustable to align your material, these 12" or 18" fence guides make precise, repeatable operations simple.

AC1910 12" Standard Handles
AC1911 18" Standard Handles
AC1912 12" Heavy Duty Handles
AC1913 18" Heavy Duty Handles

*IMAGE NOTE: Guarding removed for clarity

*IMAGE NOTE: Guarding removed for clarity



QUICK REFERENCE GUIDE

ATTACHMENTS & ACCESSORIES



ATTACHMENTS

STANDARD PUNCH ASSEMBLY	AC1023-1	AC1023-2	—	AC1023-2	—
OVERSIZED PUNCH ASSEMBLY	AC1027	AC1024	AC1024	AC1024	AC1024
241 PUNCH ASSEMBLY	AC1055-1	AC1055	AC1055	AC1055	AC1055
ANGLE NOTCHER	AC0124	AC0125-1	AC0125-1	AC0125-1	AC0125-1
COPER NOTCHER	AC1012	AC1013	Standard	AC1014	Standard
PIPE NOTCHER HOUSING	AC0925	AC0925	AC0925	AC0925	AC0925
PIPE NOTCHER HOUSING, OPEN CAVITY	—	—	—	—	—
TURRET PIPE NOTCHER HOUSING	—	AC0925T	AC0925T	AC0925T	AC0925T
MULTI-SHEAR	AC1075	AC1075	AC1075	AC1075	AC1075
ROD SHEAR	AC1074	AC1074	AC1074	AC1074	AC1074
7" BRAKE WITH 4-WAY DIE	AC1033	AC1033	AC1033	AC1033	AC1033
8" BRAKE WITH 4-WAY DIE	—	AC1034	AC1034	AC1034	AC1034
10" BRAKE WITH 4-WAY DIE	—	—	—	AC1051	—
10" BRAKE WITH 4-WAY DIE, OPEN CAVITY	—	—	—	—	—
12" BRAKE WITH 4-WAY DIE	—	—	—	—	—

ACCESSORIES

GAUGING TABLE KIT	AC0902-1	AC0900	AC0900	AC0900	AC0900
HEAVY DUTY GAUGING TABLE KIT	—	AC0903	AC0903	AC0903	AC0903
HEAVY DUTY GAUGING TABLE KIT FOR OVERSIZE PUNCH ASSEMBLY	—	AC0905	AC0905	AC0905	AC0905
COPER NOTCHER GAUGING TABLE KIT	—	—	—	AC0800	AC0800
STRIPPER REDUCING PLATE	AC1914-1	AC1914-3	AC1914-3	AC1914-3	AC1914-3
URETHANE STRIPPER	AC1099	AC1099	AC1099	AC1099	AC1099
QUICK CHANGE PUNCH ASSEMBLY	AC1001	AC1001	AC1001	AC1001	AC1001
48" AUTO CUT	—	AC1010	AC1010	AC1010	AC1010
48" BACK GAUGE	—	AC1009	AC1011	AC1011	AC1011
PRESS BRAKE BACK GAUGE	PR135	PR135	PR135	PR135	PR135
PUNCH & DIE STARTER SET	PD1000	PD1000	PD1000	PD1000	PD1000
ACCESSORY LED LIGHT	—	AC1000	AC1000	AC1000	AC1000
FABRICATOR'S PROTRACTOR	AC1017	AC1017	AC1017	AC1017	AC1017
FENCE GUIDES, SHORT 12", STANDARD HANDLES	—	AC1910	AC1910	AC1910	AC1910
FENCE GUIDES, LONG 18", STANDARD HANDLES	—	AC1911	AC1911	AC1911	AC1911
FENCE GUIDES, SHORT 12", HANDLES FOR HEAVY DUTY TABLE	—	AC1912	AC1912	AC1912	AC1912
FENCE GUIDES, LONG 18", HANDLES FOR HEAVY DUTY TABLE	—	AC1913	AC1913	AC1913	AC1913
PRODUCTIVITY PACKS	—	AC2000	AC2000	AC2000	AC2000



ATTACHMENTS

—	—	AC1023-3	—	—	AC1023-4	—
AC1024	AC1024	AC1024	AC1026	AC1026	AC1024	AC1024
AC1055-2	AC1055-2	AC1055-2	AC1055-3	AC1055-4	AC1055-5	AC1055-6
AC0125	AC0125	AC0125	AC0126	AC0126	AC0125	AC0125
Standard	Standard	AC1098	Standard	Standard	AC1097	Standard
AC0925	AC0925	AC0925	AC0925	AC0925	AC0925	AC0925
AC0925C	—	—	—	AC0925C	—	AC0925C
AC0925T	AC0925T	AC0925T	AC0925T	AC0925T	AC0925T	AC0925T
AC1075	AC1075	AC1075	AC1075	AC1075	AC1075	AC1075
AC1074	AC1074	AC1074	AC1074	AC1074	AC1074	AC1074
AC1033	AC1033	AC1033	AC1033	AC1033	AC1033	AC1033
AC1034	AC1034	AC1034	AC1034	AC1034	AC1034	AC1034
AC1051	AC1051	AC1051	AC1051	AC1051	AC1051	AC1051
AC1052	—	—	—	AC1052	—	AC1052
—	AC1035	AC1035	—	—	AC1035	AC1035

ACCESSORIES

AC0900	AC0900	AC0900	—	—	—	—
AC0903	AC0903	AC0903	AC0904	AC0904	AC0903	AC0903
AC0905	AC0905	AC0905	AC0906	AC0906	AC0905	AC0905
AC0800	AC0800	AC0800	AC0800	—	—	—
AC1914-4	AC1914-4	AC1914-4	AC1914-6	AC1914-7	—	—
AC1099	AC1099	AC1099	AC1099	AC1099	AC1099	AC1099
AC1001	AC1001	AC1001	AC1001	AC1001	AC1001	AC1001
AC1010	AC1010	AC1010	AC1010	AC1010	AC1010	AC1010
AC1011	AC1011	AC1011	AC1011	AC1011	AC1011	AC1011
PR135	PR135	PR135	PR135	PR135	PR135	PR135
PD1000	PD1000	PD1000	PD1000	PD1000	PD1000	PD1000
AC1000	AC1000	AC1000	AC1000	AC1000	AC1000	AC1000
AC1017	AC1017	AC1017	AC1017	AC1017	AC1017	AC1017
AC1910	AC1910	AC1910	AC1910	AC1910	AC1910	AC1910
AC1911	AC1911	AC1911	AC1911	AC1911	AC1911	AC1911
AC1912	AC1912	AC1912	AC1912	AC1912	AC1912	AC1912
AC1913	AC1913	AC1913	AC1913	AC1913	AC1913	AC1913
AC2000	AC2000	AC2000	AC3000	AC3000	—	—



POWER LINK™

PLUG IN. POWER UP.



THE EXCLUSIVE EDWARDS POWERLINK™ SYSTEM TURNS YOUR IRONWORKER INTO A POWER SOURCE FOR OUR EVER INCREASING LINE OF HYDRAULIC TOOLS.

- Simply Plug In & Power Up any of our ever-increasing line of Hydraulic Tools into your EDWARDS Ironworker to expand your fabrication capabilities
- 40 to 120 Ton Ironworkers offered with optional factory installed PowerLink System
- PowerLink System comes standard on Elite Ironworkers
- The EDWARDS Portable Power Unit is an additional power source with the PowerLink System



**20 TON
HORIZONTAL PRESS**

**20 TON
RADIUS ROLLER**

**10 TON
BENDER**



**20 TON
SHOP PRESS**

**40 TON
SHOP PRESS**

**60 TON
SHOP PRESS**

**110 TON
SHOP PRESS**

SHOP PRESSES ALSO AVAILABLE WITH PLC. SEE PAGE 63 AND 65 FOR DETAILS



PORTABLE POWER UNIT



FLEXIBILITY

- Mobile PowerLink System is a power source to operate all Edwards Hydraulic Tools

PRODUCTIVITY

- Heavy-duty castors provide easy portability to move around your shop
- Quick connect couplings are easy to use allowing rapid transitions between Edwards Hydraulic Tools

SAFETY

- Integrated Lock-out/Tag-out system with E-Stop for added safety



SPECIFICATIONS	
Motor	5 HP
Amps	23
Hydraulics (GPM)	3-1/2
Hydraulics (PSI)	3000
Product Dimensions (In.)	15-1/4 x 37-1/2 x 31-1/4
Shipping Dimensions (In.)	24 x 48 x 37
Weight (lbs.)	400

STOCK #	PRODUCT DESCRIPTION
HAT001	Portable Power Unit 1 Phase, 230 Volt
HAT002	Portable Power Unit 3 Phase, 230 Volt
HAT004	Portable Power Unit 3 Phase, 460 Volt

10 TON BENDER



FLEXIBILITY

- Bend a wide variety of round or square tube and pipe up to 180°
- Horizontal or Vertical operation provides the user flexibility
- Over 300 standard dies available to handle your bending needs

PRODUCTIVITY

- Requires an Edwards Ironworker with PowerLink System or a Portable Power Unit to operate
- Heavy-duty rolling base for easy movement
- Easy to use Hand/Jog controls with integrated E-Stop
- 20' quick-connect hoses for simple "plug & play" operation

PERFORMANCE

- Integrated proximity sensor and degree wheel ensure you make the right bend every time
- Built in storage on the frame keeps your Bender Dies conveniently close



SPECIFICATIONS	
Rating (Tons)	10
Bend Capacity	180°
Pipe Capacity (In.)	2 (ID) Sch 40
Tube Capacity (In.)	2-1/2 (OD) .095
Square Tube Capacity (in.)	2 (OD) .25
Cylinder (In.)	1-3/4 Ram
Stroke (In.)	14
Product Dimensions (In.)	40-1/2 x 36-1/2 x 42
Shipping Dimensions (In.)	42 x 45 x 63
Weight (lbs.)	600

STOCK #	PRODUCT DESCRIPTION
HAT1000	10 Ton Tube/Pipe Bender
HAT1010	10 Ton Bender and Portable Power Unit, 1 Phase, 230 Volt
HAT1020	10 Ton Bender and Portable Power Unit, 3 Phase, 230 Volt
HAT1040	10 Ton Bender and Portable Power Unit, 3 Phase, 460 Volt

See page 70 & 71 for a complete listing of bender dies.



20 TON RADIUS ROLLER

20 TON HORIZONTAL PRESS



FLEXIBILITY

- Bends a smooth, long diameter curve for a wide variety of materials including pipe, tube, square tube, solid round, flat bar, angle iron & channel
- Horizontal or Vertical operation provides the user flexibility
- Variable speed hydraulic drive allows users to dial in the appropriate speed for different materials
- Includes a 6 Universal Piece Die Set that accepts square tube, flat bar, angle iron, & channel
- Optional dies available for round pipe, tube or solid round

PRODUCTIVITY

- Requires an Edwards Ironworker with PowerLink System or a Portable Power Unit to operate
- Heavy-duty rolling base for easy movement
- Easy-to-use Hand/Jog controls with integrated E-Stop
- 20' quick-connect hoses for simple "plug & play" operation

PERFORMANCE

- Built in storage on the frame keeps your Dies conveniently close

ATTACHMENTS & ACCESSORIES



RADIUS ROLLER DIE ASSEMBLY

Manufactured to work with the Edwards 20 Ton Radius Roller, this die assembly allows users to make smooth, long diameter curved bends in 1.25" pipe. Easy to install and able to be conveniently stored on the 20 Ton Radius Roller frame

STOCK #	PRODUCT DESCRIPTION
RLDP1.25	Radius Roller Die Assembly, 1.25" Pipe
RLDP1.5	Radius Roller Die Assembly, 1.50" Pipe
RLDP2.0	Radius Roller Die Assembly, 2.0" Pipe
RLDT1.5	Radius Roller Die Assembly, 1.50" Tube
RLDT1.625	Radius Roller Die Assembly, 1.625" Pipe
RLDT1.75	Radius Roller Die Assembly, 1.75" Tube
RLDT1.875	Radius Roller Die Assembly, 1.875" Tube
RLDS2.0	Radius roller die assembly, 2.0" Square tube

SPECIFICATIONS

Rating (Tons)	20
Round Pipe Sch. 40 Capacity (In.)	2
Round Tube Capacity (In.)	2-1/2 (.095)
Square Tube Capacity (In.)	2 (.120)
Solid Round Capacity (In.)	1-3/8
Flat Bar (Easy Way) Capacity (In.)	3 (.375)
Flat Bar (Hard Way) Capacity (In.)	2.25 (.375)
Angle Iron Capacity (In.)	2 (.250)
Product Dimensions (In.)	43 x 45 x 49
Shipping Dimensions (In.)	45 x 51 x 52
Weight (lbs.)	994

STOCK #	PRODUCT DESCRIPTION
HAT5000	Radius Roller
HAT5010	Radius Roller and Portable Power Unit 1 Phase, 230 Volt
HAT5020	Radius Roller and Portable Power Unit 3 Phase, 230 Volt
HAT5030	Radius Roller and Portable Power Unit 3 Phase, 460 Volt



FLEXIBILITY

- Designed for maximum flexibility with 4 pin locations to accept wide variety of custom tooling
- Ships with a standard 6" Brake with 4-Way Die able to create clips, brackets, hangers and more

PRODUCTIVITY

- Requires an Edwards Ironworker with PowerLink System or a Portable Power Unit to operate
- Easy to use Hand/Jog controls with integrated E-Stop
- 20' quick-connect hoses for simple "plug & play" operation

PERFORMANCE

- Digital encoder provides enhanced accuracy for precise repeatability
- Robust construction with 2" machine heavy-duty table

ATTACHMENTS & ACCESSORIES



CLEVIS FORMING ASSEMBLY
Requires Clevis Pins to work with the 20 Ton Horizontal Press

A must have Attachment when forming a u-shaped bracket or custom fasteners. Simple to mount to the 20 Ton Horizontal Press and easily adjustable to accommodate Clevis Pins from 7/8" to 3-1/2" in diameter

SPECIFICATIONS

Rating (Tons)	20
Cylinder (In.)	2.25
Stroke (In.)	10
Work Height (In.)	38
Table Dimensions (In.)	24 x 42
Product Dimensions (In.)	26 x 43 x 49
Shipping Dimensions (In.)	30 x 48 x 60
Weight (lbs.)	1500

STOCK #	PRODUCT DESCRIPTION
HAT6000	Horizontal Press
HAT6010	Horizontal Press and Portable Power Unit 1 Phase, 230 Volt
HAT6020	Horizontal Press and Portable Power Unit 3 Phase, 230 Volt
HAT6030	Horizontal Press and Portable Power Unit 3 Phase, 460 Volt

STOCK # PRODUCT DESCRIPTION

PR135	Press Brake Back Gauge
HBA100	Clevis Forming Assembly
HBA116	1.50" Clevis Pin
HBA120	2.00" Clevis Pin
HBA121	1.26" Clevis Pin
HBA122	1.925" Clevis Pin
HBA123	2.90" Clevis Pin
HBA124	1.00" Clevis Pin
HBA126	1.625" Clevis Pin
HBA127	.75" Clevis Pin
HBA128	2.50" Clevis Pin
HBA129	1.75" Clevis Pin
HBA130	2.25" Clevis Pin
HBA200	Horizontal Press Material Stop



20 TON SHOP PRESS

40 TON SHOP PRESS



FLEXIBILITY

- Rolling cylinder provides maximum adaptability
- Open-sided design allows longer material to pass through the frame
- Accepts a variety of standard and custom tooling

PRODUCTIVITY

- Requires an Edwards Ironworker with PowerLink System or a Portable Power Unit to operate
- Easy to use Hand/Jog controls with integrated E-Stop
- 20' quick-connect hoses for simple "plug & play" operation

SAFETY

- Hydraulic-assist adjustable work table heights to maximize operator safety includes lift chains and bracket

FLEXIBILITY

- Rolling cylinder provides maximum adaptability
- Open-sided design allows longer material to pass through the frame
- Accepts a variety of standard and custom tooling

PRODUCTIVITY

- Requires an Edwards Ironworker with PowerLink System or a Portable Power Unit to operate
- Easy to use Hand/Jog controls with integrated E-Stop
- 20' quick-connect hoses for simple "plug & play" operation

SAFETY

- Hydraulic-assist adjustable work table heights to maximize operator safety includes lift chains and bracket

PERFORMANCE

- Pressure gauge provides accurate measurements allowing for easy repeatable parts production

SPECIFICATIONS

Rating (Tons)	20
Cylinder (In.)	2
Stroke (In.)	6-1/4
Minimum Ram Speed (In./Sec)	1.091
Minimum Return Speed (In./Sec)	1.667
Work Table (In.)	10-1/2 x 20
Steel Frame Thickness (In.)	3/8
Product Dimensions (In.)	24 x 27 x 37
Shipping Dimensions (In.)	30 x 30 x 43
Weight (lbs.)	392

ATTACHMENTS & ACCESSORIES



6 PIECE PRESS TOOLING SET
Compatible with Edwards 20 & 40 Ton Shop Presses

The Six Piece Press Tooling Set includes both tapered, cutaway, and various diameter push blocks to allow users to press bearings, bend metal or straighten parts. Easy to install on the Edwards 20 & 40 Ton Shop Presses, this versatile set has a piece of tooling to fit all your needs.

STOCK # PRODUCT DESCRIPTION

PRB06	Six Piece Press Tooling Set for 20 & 40 Ton Shop Presses
PRB12	12" Press Brake Tooling
PR135	Press Brake Back Gauge

STOCK # PRODUCT DESCRIPTION

HAT2000	20 Ton Shop Press
HAT2010	20 Ton Shop Press and Portable Power Unit 1 Phase, 230 Volt
HAT2020	20 Ton Shop Press and Portable Power Unit 3 Phase, 230 Volt
HAT2030	20 Ton Shop Press and Portable Power Unit 3 Phase, 460 Volt

SPECIFICATIONS

Rating (Tons)	40
Cylinder (In.)	4
Stroke (In.)	12-1/4
Minimum Ram Speed (In./Sec)	.517
Minimum Return Speed (In./Sec)	.893
Work Table (In.)	38 x 40-1/2
Steel Frame Thickness (In.)	1/2
Product Dimensions (In.)	48 x 48 x 79
Shipping Dimensions (In.)	54 x 54 x 89
Weight (lbs.)	1400

STOCK # PRODUCT DESCRIPTION

HAT4000	40 Ton Shop Press
HAT4010	40 Ton Shop Press and Portable Power Unit 1 Phase, 230 Volt
HAT4020	40 Ton Shop Press and Portable Power Unit 3 Phase, 230 Volt
HAT4030	40 Ton Shop Press and Portable Power Unit 3 Phase, 460 Volt

ATTACHMENTS & ACCESSORIES

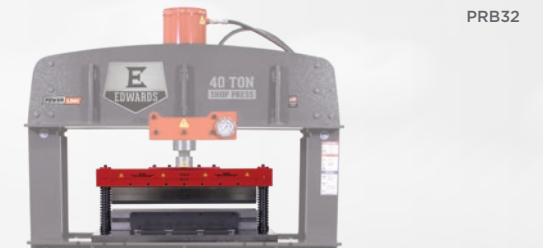

PRESS BREAK TOOLING

Designed to compliment the Edwards Shop Presses, the 12" Press Brake Tooling turns your Shop Press into a brake. Fabricate brackets, frames, pans and tanks with this Brake with 4-Way Die. Includes a standard punch that allows 1/16", 1/8", 3/16" and 1/4" material to be formed to a 90° angle. Easily create repeatable bends when paired with the Press Brake Back Gauge.

STOCK # PRODUCT DESCRIPTION

PRB06	Six Piece Press Tooling Set for 20 & 40 Ton Shop Presses
PRB12	12" Press Brake Tooling
PRB18	18" Press Brake Tooling
PRB24	24" Press Brake Tooling
PRB32	32" Press Brake Tooling
PR135	Press Brake Back Gauge



60 TON SHOP PRESS



FLEXIBILITY

- Rolling cylinder provides maximum adaptability
- Open-sided design allows longer material to pass through the frame
- Accepts a variety of standard and custom tooling

PRODUCTIVITY

- Requires an Edwards Ironworker with PowerLink System or a Portable Power Unit to operate
- Electric foot pedal with integrated jog control
- 20' quick-connect hoses for simple "plug & play" operation

SAFETY

- Hydraulic-assist adjustable work table heights to maximize operator safety includes lift chains and bracket

PERFORMANCE

- Pressure gauge provides accurate measurements allowing for easy repeatable parts production

SPECIFICATIONS

Rating (Tons)	60
Cylinder (In.)	4
Stroke (In.)	12-1/4
Minimum Ram Speed (In./Sec)	.330
Minimum Return Speed (In./Sec)	.456
Work Table (In.)	39-1/4 x 42
Steel Frame Thickness (In.)	1/2
Product Dimensions (In.)	48 x 54 x 86
Shipping Dimensions (In.)	48 x 54 x 90
Weight (lbs.)	1900

STOCK # PRODUCT DESCRIPTION

HAT8000	60 Ton Shop Press
HAT8010	60 Ton Shop Press and Portable Power Unit 1 Phase, 230 Volt
HAT8020	60 Ton Shop Press and Portable Power Unit 3 Phase, 230 Volt
HAT8030	60 Ton Shop Press and Portable Power Unit 3 Phase, 460 Volt

ATTACHMENTS & ACCESSORIES



6 PIECE PRESS TOOLING SET
Compatible with Edwards 60 & 110 Ton Shop Presses

The Six Piece Press Tooling Set includes both tapered, cutaway, and various diameter push blocks to allow users to press bearings, bend metal or straighten part. Easy to install on the Edwards 60 & 110 Ton Shop Presses, this versatile set has a piece of tooling to fit all your needs

STOCK # PRODUCT DESCRIPTION

PRB06-1	Six Piece Press Tooling Set for 60 & 110 Ton Shop Presses
PRB12	12" Press Brake Tooling
PRB18	18" Press Brake Tooling
PRB24	24" Press Brake Tooling
PRB32	32" Press Brake Tooling
PR135	Press Brake Back Gauge
PRB60	Press Brake Mounting Kit for 60 Ton Shop Press
PR231	V-Block Base - 60 Ton Shop Press

60 TON SHOP PRESS WITH PLC



FLEXIBILITY

- Rolling cylinder provides maximum adaptability
- Open-sided design allows longer material to pass through the frame
- Accepts a variety of standard and custom tooling

PRODUCTIVITY

- Requires an Edwards Ironworker with PowerLink System or a Portable Power Unit to operate
- Electric foot pedal with integrated jog control
- 20' quick-connect hoses for simple "plug & play" operation

SAFETY

- Hydraulic-assist adjustable work table heights to maximize operator safety includes lift chains and bracket

PERFORMANCE

- Programmable Logic Control (PLC) allows operators to create repeatable actions improving efficiency
- The PLC offers adjustable up/down stroke control providing up to 50% time savings

SPECIFICATIONS

Rating (Tons)	60
Cylinder (In.)	4
Stroke (In.)	12-1/4
Minimum Ram Speed (In./Sec)	.330
Minimum Return Speed (In./Sec)	.456
Work Table (In.)	39-1/4 x 42
Steel Frame Thickness (In.)	1/2 & 3/4
Product Dimensions (In.)	48 x 54 x 86
Shipping Dimensions (In.)	48 x 54 x 90
Weight (lbs.)	1900

STOCK # PRODUCT DESCRIPTION

HAT8050	60 Ton Shop Press with PLC
HAT8060	60 Ton Shop Press with PLC and Portable Power Unit 1 Phase, 230 Volt
HAT8070	60 Ton Shop Press with PLC and Portable Power Unit 3 Phase, 230 Volt
HAT8080	60 Ton Shop Press with PLC and Portable Power Unit 3 Phase, 460 Volt



PROGRAMMABLE LOGIC CONTROL [PLC]

- Improve your productivity up to 50% with PLC (Programmable Logic Control) by creating repeatable actions
- Provides adjustable up/down stroke control for time savings
- Adjustable PSI allows the user to set the desired pressure accurately
- Magnetic control box mounts anywhere on the Shop Press for easy access

ATTACHMENTS & ACCESSORIES



PRESS BRAKE TOOLING

Designed to compliment the Edwards Shop Presses, the 12" Press Brake Tooling turns your Shop Press into a brake. Fabricate brackets, frames, pans and tanks with this Brake with 4-Way Die. Includes a standard punch that allows 1/16", 1/8", 3/16" and 1/4" material to be formed to a 90° angle. Easily create repeatable bends when paired with the Press Brake Back Gauge.

STOCK # PRODUCT DESCRIPTION

PRB06-1	Six Piece Press Tooling Set for 60 & 110 Ton Shop Presses
PRB12	12" Press Brake Tooling
PRB18	18" Press Brake Tooling
PRB24	24" Press Brake Tooling
PRB32	32" Press Brake Tooling
PR135	Press Brake Back Gauge
PRB60	Press Brake Mounting Kit for 60 Ton Shop Press
PR231	V-Block Base - 60 Ton Shop Press



110 TON SHOP PRESS



FLEXIBILITY

- Rolling cylinder provides maximum adaptability
- Open-sided design allows longer material to pass through the frame
- Accepts a variety of standard and custom tooling

PRODUCTIVITY

- Requires an Edwards Ironworker with PowerLink System or a Portable Power Unit to operate
- Electric foot pedal with integrated jog control
- 20' quick-connect hoses for simple "plug & play" operation

SAFETY

- Hydraulic-assist adjustable work table heights to maximize operator safety includes lift chains and bracket

PERFORMANCE

- Pressure gauge provides accurate measurements allowing for easy repeatable parts production

SPECIFICATIONS

Rating (Tons)	110
Cylinder (In.)	4
Stroke (In.)	12-1/4
Minimum Ram Speed (In./Sec)	.186
Minimum Return Speed (In./Sec)	.220
Work Table (In.)	37-7/16 x 48
Steel Frame Thickness (In.)	3/4
Product Dimensions (In.)	48 x 64 x 88
Shipping Dimensions (In.)	48 x 64 x 92
Weight (lbs.)	2690

STOCK #	PRODUCT DESCRIPTION
HAT9000	110 Ton Shop Press
HAT9010	110 Ton Shop Press and Portable Power Unit 1 Phase, 230 Volt
HAT9020	110 Ton Shop Press and Portable Power Unit 3 Phase, 230 Volt
HAT9030	110 Ton Shop Press and Portable Power Unit 3 Phase, 460 Volt

ATTACHMENTS & ACCESSORIES



6 PIECE PRESS TOOLING SET
Compatible with Edwards 60 & 110 Ton Shop Presses

The Six Piece Press Tooling Set includes both tapered, cutaway, and various diameter push blocks to allow users to press bearings, bend metal or straighten part. Easy to install on the Edwards 60 & 110 Ton Shop Presses, this versatile set has a piece of tooling to fit all your needs

STOCK #	PRODUCT DESCRIPTION
PRB06-1	Six Piece Press Tooling Set for 60 & 110 Ton Shop Presses
PRB12	12" Press Brake Tooling
PRB18	18" Press Brake Tooling
PRB24	24" Press Brake Tooling
PRB32	32" Press Brake Tooling
PR135	Press Brake Back Gauge
PRB110	Press Brake Mounting Kit for 110 Ton Shop Press
PR230	V-Block Base - 110 Ton Shop Press

110 TON SHOP PRESS WITH PLC



FLEXIBILITY

- Rolling cylinder provides maximum adaptability
- Open-sided design allows longer material to pass through the frame
- Accepts a variety of standard and custom tooling

PRODUCTIVITY

- Requires an Edwards Ironworker with PowerLink System or a Portable Power Unit to operate
- Electric foot pedal with integrated jog control
- 20' quick-connect hoses for simple "plug & play" operation

SAFETY

- Hydraulic-assist adjustable work table heights to maximize operator safety includes lift chains and bracket

PERFORMANCE

- Programmable Logic Control (PLC) allows operators to create repeatable actions improving efficiency
- The PLC offers adjustable up/down stroke control providing up to 50% time savings

SPECIFICATIONS

Rating (Tons)	110
Cylinder (In.)	4
Stroke (In.)	12-1/4
Minimum Ram Speed (In./Sec)	.186
Minimum Return Speed (In./Sec)	.220
Work Table (In.)	37-7/16 x 48
Steel Frame Thickness (In.)	3/4
Product Dimensions (In.)	48 x 64 x 88
Shipping Dimensions (In.)	48 x 64 x 86
Weight (lbs.)	2690

STOCK #	PRODUCT DESCRIPTION
HAT9050	110 Ton Shop Press with PLC
HAT9060	110 Ton Shop Press with PLC and Portable Power Unit 1 Phase, 230 Volt
HAT9070	110 Ton Shop Press with PLC and Portable Power Unit 3 Phase, 230 Volt
HAT9080	110 Ton Shop Press with PLC and Portable Power Unit 3 Phase, 460 Volt



PROGRAMMABLE LOGIC CONTROL [PLC]

- Improve your productivity up to 50% with PLC (Programmable Logic Control) by creating repeatable actions
- Provides adjustable up/down stroke control for time savings
- Adjustable PSI allows the user to set the desired pressure accurately
- Magnetic control box mounts anywhere on the Shop Press for easy access

ATTACHMENTS & ACCESSORIES

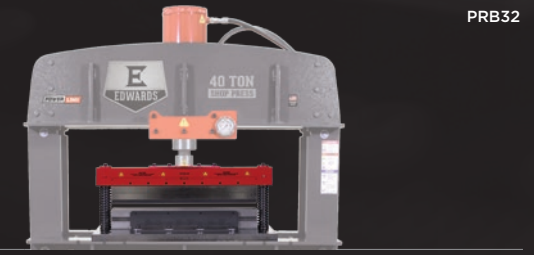

PRESS BRAKE TOOLING

Designed to compliment the Edwards Shop Presses, the 12" Press Brake Tooling turns your Shop Press into a brake. Fabricate brackets, frames, pans and tanks with this Brake with 4-Way Die. Includes a standard punch that allows 1/16", 1/8", 3/16" and 1/4" material to be formed to a 90° angle. Easily create repeatable bends when paired with the Press Brake Back Gauge.

STOCK #	PRODUCT DESCRIPTION
PRB06-1	Six Piece Press Tooling Set for 60 & 110 Ton Shop Presses
PRB12	12" Press Brake Tooling
PRB18	18" Press Brake Tooling
PRB24	24" Press Brake Tooling
PRB32	32" Press Brake Tooling
PR135	Press Brake Back Gauge
PRB110	Press Brake Mounting Kit for 110 Ton Shop Press
PR230	V-Block Base - 110 Ton Shop Press



ALLIGATOR SHEARS

HOLE SAW NOTCHER

MANUAL

- The Edwards # 5 Manual Alligator Shear has a sturdy, cast-iron frame built to withstand heavy use
- Excellent for shearing flat, round or square bar
- The six foot steel handle provides leverage for easier shearing



HYDRAULIC

- The Edwards # 7 Hydraulic Alligator Shear is a powerful, straightforward machine
- The 3HP motor provides ample power to effortlessly shear flat, round or square bar
- Save time and increase your productivity with this hydraulic shear



SPECIFICATIONS	
Flat Bar Shear Max Capacity (In.)	4 x 1/2 6 x 5/16
Flat Bar Shear Max Round Capacity (In.)	3/4 diam.
Flat Bar Shear Max Square Capacity (In.)	3/4
Shipping Dimensions (In.)	48 x 40 x 20
Weight (lbs.)	250

STOCK #	PRODUCT DESCRIPTION
SH5	#5 Shear

SPECIFICATIONS	
Flat Bar Shear Max Capacity (In.)	4 x 1/2 6 x 5/16
Flat Bar Shear Max Round Capacity (In.)	3/4 diam.
Flat Bar Shear Max Square Capacity (In.)	3/4
Motor	3HP
Shipping Dimensions (In.)	48 x 48 x 60
Weight (lbs.)	860

STOCK #	PRODUCT DESCRIPTION
SH7-1P230	#7 Shear - 1 Phase, 230 Volt
SH7-3P230	#7 Shear - 3 Phase, 230 Volt
SH7-3P460	#7 Shear - 3 Phase, 460 Volt

FLEXIBILITY

- Multi-positional vice provides 360° rotation for maximum notching range
- Vice capable of offset notching with up to 3/4" of vertical movement
- Compatible with most commercially available hole saws

PRODUCTIVITY

- Integrated drawer is perfect for tool storage or extra Hole Saws
- Multiple scales and alignment guides make repeatable notching simple

SAFETY

- Safety guarding protects all moving parts
- CSA/CUS Certification: complies with strict guidelines and electrical requirements
- Safety Locking ON/OFF Switch

PERFORMANCE

- Vertical motor orientation reduces vibration
- Chip guards and downward gear rack prevent chip interference
- Heavy-duty steel base can be bolted to any work table or our accessory Deluxe Stand
- Integrated base plate guide rails provide smooth travel



SPECIFICATIONS	
Motor	3/4 HP, 115/230V, 1Ph
Amps	7
Motor RPM	1750
Angle Adjustment	360°
Sch. 40 Pipe Notching Capacity (In.)	3/8 - 2-1/2
Tube Notching Capacity OD (In.)	5/8 x 3
Offset Notching Range (In.)	3/4
Cutting RPM	233
Product Dimensions (In.)	29 x 19 x 28-1/2
Shipping Dimensions (In.)	31 x 21 x 34
Weight (lbs.)	220

STOCK #	PRODUCT DESCRIPTION
HS1000	Hole Saw Tube/Pipe Notcher
ST2000	Deluxe Stand



Deluxe Stand
ST2000
(sold separately)



PUNCH & DIE SETS

PUNCH & DIE SETS

Punch & Die Sets to work with all Edwards Ironworkers are designed to be long-lasting and precise. We offer hundreds of sizes to make whatever size and shape hole your project needs. If you can't find what you need, call for a custom quote.

IMPORTANT

The thickness of the material should not exceed the punch diameter.

TONNAGE

Use the following formula to calculate the tonnage required to punch a round hole in mild steel:
 • Punch diameter x Material Thickness x 80 = Tons of pressure required

EXAMPLE

To punch a 1/2" hole through 1/4" thick mild steel $0.500 \times 0.250 \times 80 = 10$ tons required.

CALL

To speak with our knowledgeable Technical Sales staff for custom applications or specialty tooling.

1.800.373.8206



STANDARD ROUND PUNCH & DIE SETS	
STOCK #	PRODUCT DESCRIPTION
PD1/8	1/8" ROUND PUNCH & DIE SET
PD5/32	5/32" ROUND PUNCH & DIE SET
PD3/16	3/16" ROUND PUNCH & DIE SET
PD7/32	7/32" ROUND PUNCH & DIE SET
PD1/4	1/4" ROUND PUNCH & DIE SET
PD9/32	9/32" ROUND PUNCH & DIE SET
PD5/16	5/16" ROUND PUNCH & DIE SET
PD11/32	11/32" ROUND PUNCH & DIE SET
PD3/8	3/8" ROUND PUNCH & DIE SET
PD13/32	13/32" ROUND PUNCH & DIE SET
PD7/16	7/16" ROUND PUNCH & DIE SET
PD15/32	15/32" ROUND PUNCH & DIE SET
PD1/2	1/2" ROUND PUNCH & DIE SET
PD17/32	17/32" ROUND PUNCH & DIE SET
PD9/16	9/16" ROUND PUNCH & DIE SET
PD19/32	19/32" ROUND PUNCH & DIE SET
PD5/8	5/8" ROUND PUNCH & DIE SET
PD21/32	21/32" ROUND PUNCH & DIE SET
PD11/16	11/16" ROUND PUNCH & DIE SET
PD23/32	23/32" ROUND PUNCH & DIE SET
PD3/4	3/4" ROUND PUNCH & DIE SET
PD25/32	25/32" ROUND PUNCH & DIE SET
PD13/16	13/16" ROUND PUNCH & DIE SET
PD27/32	27/32" ROUND PUNCH & DIE SET
PD7/8	7/8" ROUND PUNCH & DIE SET
PD29/32	29/32" ROUND PUNCH & DIE SET
PD15/16	15/16" ROUND PUNCH & DIE SET
PD31/32	31/32" ROUND PUNCH & DIE SET
PD1	1" ROUND PUNCH & DIE SET
PD1-1/32	1-1/32" ROUND PUNCH & DIE SET
PD1-1/16	1-1/16" ROUND PUNCH & DIE SET
PD1-1/8	1-1/8" ROUND PUNCH & DIE SET*

OVERSIZE ROUND PUNCH & DIE SETS	
STOCK #	PRODUCT DESCRIPTION
PDOS1	1" OVERSIZE ROUND PUNCH & DIE SET
PDOS1-1/32	1-1/32" OVERSIZE ROUND PUNCH & DIE SET
PDOS1-1/16	1-1/16" OVERSIZE ROUND PUNCH & DIE SET
PDOS1-3/32	1-3/32" OVERSIZE ROUND PUNCH & DIE SET
PDOS1-1/8	1-1/8" OVERSIZE ROUND PUNCH & DIE SET
PDOS1-5/32	1-5/32" OVERSIZE ROUND PUNCH & DIE SET
PDOS1-3/16	1-3/16" OVERSIZE ROUND PUNCH & DIE SET
PDOS1-7/32	1-7/32" OVERSIZE ROUND PUNCH & DIE SET
PDOS1-1/4	1-1/4" OVERSIZE ROUND PUNCH & DIE SET
PDOS1-9/32	1-9/32" OVERSIZE ROUND PUNCH & DIE SET
PDOS1-5/16	1-5/16" OVERSIZE ROUND PUNCH & DIE SET
PDOS1-11/32	1-11/32" OVERSIZE ROUND PUNCH & DIE SET
PDOS1-3/8	1-3/8" OVERSIZE ROUND PUNCH & DIE SET
PDOS1-13/32	1-13/32" OVERSIZE ROUND PUNCH & DIE SET
PDOS1-7/16	1-7/16" OVERSIZE ROUND PUNCH & DIE SET
PDOS1-15/32	1-15/32" OVERSIZE ROUND PUNCH & DIE SET
PDOS1-1/2	1-1/2" OVERSIZE ROUND PUNCH & DIE SET
PDOS1-17/32	1-17/32" OVERSIZE ROUND PUNCH & DIE SET
PDOS1-9/16	1-9/16" OVERSIZE ROUND PUNCH & DIE SET

ALL OVERSIZE ROUND PUNCH & DIE SETS REQUIRE AN OVERSIZE PUNCH ASSEMBLY

STOCK #	PRODUCT DESCRIPTION
AC1024	OVERSIZE PUNCH ASSEMBLY 40T, 50T, 55T, 60T, 65T, 75T, 100T, 100T DLX IRONWORKERS
AC1026	OVERSIZE PUNCH ASSEMBLY 100T DLX, 120T IRONWORKERS
AC1027	OVERSIZE PUNCH ASSEMBLY 25T IRONWORKERS

* REQUIRES STOCK # PD0222, COUPLING NUT



- Includes 8 standard round punch & die sets selected to accommodate the most commonly used bolts
- Sized in 1/8" increments from 3/16" to 1-1/16" with 1/32" clearance
- Made of durable tool steel for long life
- Compatible with standard Pedestal Die Table
- Keep organized with our convenient storage case

PUNCH AND DIE STARTER SET

STOCK #	PRODUCT DESCRIPTION
PD1000	PUNCH AND DIE STARTER SET



PUNCH & DIE SETS

PUNCH & DIE SETS

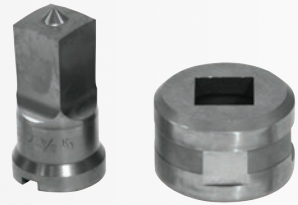

STANDARD SQUARE PUNCH & DIE SETS	
STOCK #	PRODUCT DESCRIPTION
PDSQ1/4	1/4" SQUARE PUNCH & DIE SET WITH KEY-WAY
PDSQ5/16	5/16" SQUARE PUNCH & DIE SET WITH KEY-WAY
PDSQ11/32	11/32" SQUARE PUNCH & DIE SET WITH KEY-WAY
PDSQ3/8	3/8" SQUARE PUNCH & DIE SET WITH KEY-WAY
PDSQ13/32	13/32" SQUARE PUNCH & DIE SET WITH KEY-WAY
PDSQ7/16	7/16" SQUARE PUNCH & DIE SET WITH KEY-WAY
PDSQ15/32	15/32" SQUARE PUNCH & DIE SET WITH KEY-WAY
PDSQ1/2	1/2" SQUARE PUNCH & DIE SET WITH KEY-WAY
PDSQ17/32	17/32" SQUARE PUNCH & DIE SET WITH KEY-WAY
PDSQ9/16	9/16" SQUARE PUNCH & DIE SET WITH KEY-WAY
PDSQ19/32	19/32" SQUARE PUNCH & DIE SET WITH KEY-WAY
PDSQ5/8	5/8" SQUARE PUNCH & DIE SET WITH KEY-WAY
PDSQ21/32	21/32" SQUARE PUNCH & DIE SET WITH KEY-WAY
PDSQ11/16	11/16" SQUARE PUNCH & DIE SET WITH KEY-WAY
PDSQ23/32	23/32" SQUARE PUNCH & DIE SET WITH KEY-WAY
PDSQ3/4	3/4" SQUARE PUNCH & DIE SET WITH KEY-WAY
PDSQ25/32	25/32" SQUARE PUNCH & DIE SET WITH KEY-WAY*
PDSQ13/16	13/16" SQUARE PUNCH & DIE SET WITH KEY-WAY*

* REQUIRES STOCK # PD0222, COUPLING NUT

STANDARD OBLONG PUNCH & DIE SETS	
STOCK #	PRODUCT DESCRIPTION
PDOB1/4X1/2	1/4X1/2 OBLONG PUNCH & DIE SET WITH KEY-WAY
PDOB9/32X9/16	9/32X9/16 OBLONG PUNCH & DIE SET WITH KEY-WAY
PDOB3/16X3/4	3/16X3/4 OBLONG PUNCH & DIE SET WITH KEY-WAY
PDOB1/4X3/4	1/4X3/4 OBLONG PUNCH & DIE SET WITH KEY-WAY
PDOB5/16X3/4	5/16X3/4 OBLONG PUNCH & DIE SET WITH KEY-WAY
PDOB7/16X3/4	7/16X3/4 OBLONG PUNCH & DIE SET WITH KEY-WAY
PDOB9/16X3/4	9/16X3/4 OBLONG PUNCH & DIE SET WITH KEY-WAY
PDOB3/8X3/4	3/8X3/4 OBLONG PUNCH & DIE SET WITH KEY-WAY
PDOB1/2X3/4	1/2X3/4 OBLONG PUNCH & DIE SET WITH KEY-WAY
PDOB13/32X13/16	13/32X13/16 OBLONG PUNCH & DIE SET WITH KEY-WAY
PDOB3/16X1	3/16X1 OBLONG PUNCH & DIE SET WITH KEY-WAY
PDOB1/4X1	1/4X1 OBLONG PUNCH & DIE SET WITH KEY-WAY
PDOB9/32X1	9/32X1 OBLONG PUNCH & DIE SET WITH KEY-WAY
PDOB5/16X1	5/16X1 OBLONG PUNCH & DIE SET WITH KEY-WAY
PDOB11/32X1	11/32X1 OBLONG PUNCH & DIE SET WITH KEY-WAY
PDOB3/8X1	3/8X1 OBLONG PUNCH & DIE SET WITH KEY-WAY
PDOB13/32X1	13/32X1 OBLONG PUNCH & DIE SET WITH KEY-WAY
PDOB7/16X1	7/16X1 OBLONG PUNCH & DIE SET WITH KEY-WAY
PDOB1/2X1	1/2X1 OBLONG PUNCH & DIE SET WITH KEY-WAY
PDOB17/32X1	17/32X1 OBLONG PUNCH & DIE SET WITH KEY-WAY
PDOB9/16X1	9/16X1 OBLONG PUNCH & DIE SET WITH KEY-WAY
PDOB5/8X1	5/8X1 OBLONG PUNCH & DIE SET WITH KEY-WAY
PDOB11/16X1	11/16X1 OBLONG PUNCH & DIE SET WITH KEY-WAY
PDOB3/4X1	3/4X1 OBLONG PUNCH & DIE SET WITH KEY-WAY
PDOB13/16X1	13/16X1 OBLONG PUNCH & DIE SET WITH KEY-WAY
PDOB5/16X1-1/16	5/16X1-1/16 OBLONG PUNCH & DIE SET WITH KEY-WAY
PDOB3/8X1-1/16	3/8X1-1/16 OBLONG PUNCH & DIE SET WITH KEY-WAY
PDOB9/16X1-1/16	9/16X1-1/16 OBLONG PUNCH & DIE SET WITH KEY-WAY
PDOB11/16X1-1/16	11/16X1-1/16 OBLONG PUNCH & DIE SET WITH KEY-WAY
PDOB13/16X1-1/16	13/16X1-1/16 OBLONG PUNCH & DIE SET WITH KEY-WAY

STANDARD METRIC PUNCH & DIE SETS	
STOCK #	PRODUCT DESCRIPTION
PDM4	4MM METRIC PUNCH & DIE SET
PDM5	5MM METRIC PUNCH & DIE SET
PDM6	6MM METRIC PUNCH & DIE SET
PDM7	7MM METRIC PUNCH & DIE SET
PDM8	8MM METRIC PUNCH & DIE SET
PDM9	9MM METRIC PUNCH & DIE SET
PDM10	10MM METRIC PUNCH & DIE SET
PDM10.5	10.5MM METRIC PUNCH & DIE SET
PDM11	11MM METRIC PUNCH & DIE SET
PDM12	12MM METRIC PUNCH & DIE SET
PDM13	13MM METRIC PUNCH & DIE SET
PDM14	14MM METRIC PUNCH & DIE SET
PDM15	15MM METRIC PUNCH & DIE SET
PDM16	16MM METRIC PUNCH & DIE SET
PDM16.5	16.5MM METRIC PUNCH & DIE SET
PDM17	17MM METRIC PUNCH & DIE SET
PDM18	18MM METRIC PUNCH & DIE SET
PDM19	19MM METRIC PUNCH & DIE SET
PDM20	20MM METRIC PUNCH & DIE SET
PDM20.5	20.5MM METRIC PUNCH & DIE SET
PDM21	21MM METRIC PUNCH & DIE SET
PDM21.5	21.5MM METRIC PUNCH & DIE SET
PDM22	22MM METRIC PUNCH & DIE SET
PDM23	23MM METRIC PUNCH & DIE SET
PDM24	24MM METRIC PUNCH & DIE SET
PDM24.5	24.5MM METRIC PUNCH & DIE SET
PDM25	25MM METRIC PUNCH & DIE SET
PDM26	26MM METRIC PUNCH & DIE SET

STANDARD HEXAGON PUNCH & DIE SETS	
STOCK #	PRODUCT DESCRIPTION
PDH3/8	3/8" HEX PUNCH & DIE SET WITH KEY-WAY
PDH7/16	7/16" HEX PUNCH & DIE SET WITH KEY-WAY
PDH15/32	15/32" HEX PUNCH & DIE SET WITH KEY-WAY
PDH1/2	1/2" HEX PUNCH & DIE SET WITH KEY-WAY
PDH17/32	17/32" HEX PUNCH & DIE SET WITH KEY-WAY
PDH9/16	9/16" HEX PUNCH & DIE SET WITH KEY-WAY
PDH19/32	19/32" HES PUNCH & DIE SET WITH KEY-WAY
PDH5/8	5/8" HEX PUNCH & DIE SET WITH KEY-WAY
PDH11/16	11/16" HEX PUNCH & DIE SET WITH KEY-WAY
PDH23/32	23/32" HEX PUNCH & DIE SET WITH KEY-WAY
PDH3/4	3/4" HEX PUNCH & DIE SET WITH KEY-WAY
PDH25/32	25/32" HEX PUNCH & DIE SET WITH KEY-WAY



PIPE BENDER DIES

TUBE BENDER DIES

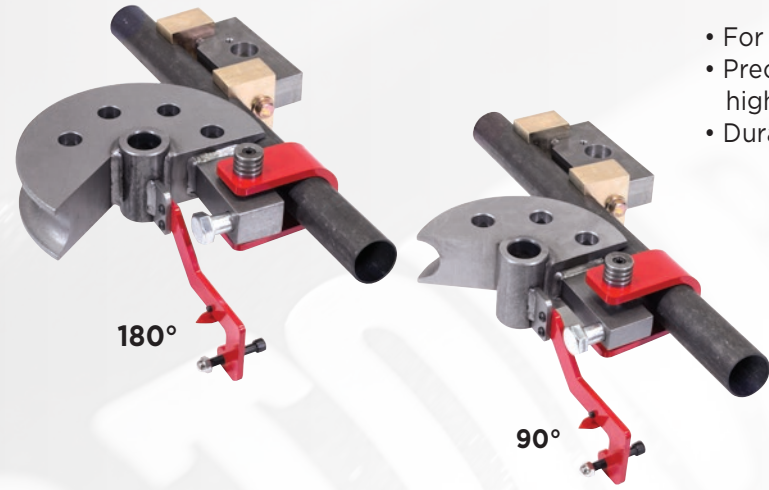

- For use with Edwards 10 Ton Bender
- Precision machined components to ensure the highest quality bends
- Durable brass follower provides extra long life

PIPE BENDER DIES 180°

BEND RADIUS	3"	3.5"	4"	4.5"	5"	5.5"	6"	6.5"	7"	7.5"
PIPE SIZE										
1/4"	PBD180/.25X3	PBD180/.25X3.5								
3/8"	PBD180/.375X3	PBD180/.375X3.5								
1/2"	PBD180/.5X3	PBD180/.5X3.5	PBD180/.5X4	PBD180/.5X4.5						
3/4"	PBD180/.75X3	PBD180/.75X3.5	PBD180/.75X4	PBD180/.75X4.5		PBD180/.75X5.5		PBD180/.75X6.5		
1"	PBD180/1X3	PBD180/1X3.5	PBD180/1X4	PBD180/1X4.5	PBD180/1X5	PBD180/1X5.5	PBD180/1X6	PBD180/1X6.5		PBD180/1X7.5
1-1/4"		PBD180/1.25X3.5	PBD180/1.25X4	PBD180/1.25X4.5	PBD180/1.25X5	PBD180/1.25X5.5	PBD180/1.25X6	PBD180/1.25X6.5	PBD180/1.25X7	
1-1/2"				PBD180/1.5X4.5	PBD180/1.5X5	PBD180/1.5X5.5	PBD180/1.5X6	PBD180/1.5X6.5	PBD180/1.5X7	PBD180/1.5X7.5
2"						PBD180/2X5.5	PBD180/2X6	PBD180/2X6.5		PBD180/2X7.5

PIPE BENDER DIES 90°

BEND RADIUS	3"	3.5"	4"	4.5"	5"	5.5"	6"	6.5"	7"	7.5"
PIPE SIZE										
1/4"	PBD90/.25X3	PBD90/.25X3.5								
3/8"	PBD90/.375X3	PBD90/.375X3.5								
1/2"	PBD90/.5X3	PBD90/.5X3.5	PBD90/.5X4	PBD90/.5X4.5						
3/4"	PBD90/.75X3	PBD90/.75X3.5	PBD90/.75X4	PBD90/.75X4.5		PBD90/.75X5.5		PBD90/.75X6.5		
1"	PBD90/1X3	PBD90/1X3.5	PBD90/1X4	PBD90/1X4.5	PBD90/1X5	PBD90/1X5.5	PBD90/1X6	PBD90/1X6.5		PBD90/1X7.5
1-1/4"		PBD90/1.25X3.5	PBD90/1.25X4	PBD90/1.25X4.5	PBD90/1.25X5	PBD90/1.25X5.5	PBD90/1.25X6	PBD90/1.25X6.5	PBD90/1.25X7	
1-1/2"			PBD90/1.5X4	PBD90/1.5X4.5	PBD90/1.5X5	PBD90/1.5X5.5	PBD90/1.5X6	PBD90/1.5X6.5	PBD90/1.5X7	PBD90/1.5X7.5
2"						PBD90/2X5.5	PBD90/2X6	PBD90/2X6.5		PBD90/2X7.5

TUBE BENDER DIES 180°

BEND RADIUS	2"	2.25"	2.5"	3"	3.5"	4"	4.5"	5"	5.5"	6"	6.5"	7"	7.5"
PIPE SIZE													
1/2"	TD180/.5X2	TD180/.5X2.25	TD180/.5X2.5	TD180/.5X3				TD180/.5X4.5					
5/8"		TD180/.625X2.25	TD180/.625X2.5	TD180/.625X3	TD180/.625X3.5								
3/4"		TD180/.75X2.25	TD180/.75X2.5	TD180/.75X3	TD180/.75X3.5	TD180/.75X4	TD180/.75X4.5		TD180/.75X5.5		TD180/.75X6.5		
7/8"			TD180/.875X2.5	TD180/.875X3	TD180/.875X3.5	TD180/.875X4	TD180/.875X4.5		TD180/.875X5.5				
1"				TD180/1X3	TD180/1X3.5	TD180/1X4	TD180/1X4.5		TD180/1X5.5	TD180/1X6	TD180/1.0X6.5		TD180/1X7.5
1-1/8"				TD180/1.125X3	TD180/1.125X3.5	TD180/1.125X4	TD180/1.125X4.5		TD180/1.125X5.5				
1-1/4"					TD180/1.25X3.5	TD180/1.25X4	TD180/1.25X4.5	TD180/1.25X5	TD180/1.25X5.5	TD180/1.25X6	TD180/1.25X6.5	TD180/1.25X7	
1-3/8"							TD180/1.375X4.5	TD180/1.375X5	TD180/1.375X5.5	TD180/1.375X6	TD180/1.375X6.5		TD180/1.375X7.5
1-1/2"							TD180/1.5X4.5	TD180/1.5X5	TD180/1.5X5.5	TD180/1.5X6	TD180/1.5X6.5	TD180/1.5X7	TD180/1.5X7.5
1-5/8"									TD180/1.625X5.5	TD180/1.625X6	TD180/1.625X6.5	TD180/1.625X7	TD180/1.625X7.5
1-3/4"									TD180/1.75X5.5	TD180/1.75X6	TD180/1.75X6.5	TD180/1.75X7	TD180/1.75X7.5
1-7/8"										TD180/1.875X6	TD180/1.875X6.5	TD180/1.875X7	TD180/1.875X7.5
2"									TD180/2X5.5	TD180/2X6	TD180/2X6.5	TD180/2X7	TD180/2X7.5
2-1/8"											TD180/2.125X6.5		TD180/2.125X7.5
2-1/4"											TD180/2.25X6.5		TD180/2.25X7.5
2-3/8"											TD180/2.375X6.5		TD180/2.375X7.5
2-1/2"											TD180/2.5X6.5		TD180/2.5X7.5

TUBE BENDER DIES 90°

BEND RADIUS	2.25"	2.5"	3"	3.5"	4"	4.5"	5"	5.5"	6"	6.5"	7"	7.5"
PIPE SIZE												
1/2"	TD90/.5X2.25	TD90/.5X2.5	TD90/.5X3				TD90/.5X4.5					
5/8"	TD90/.625X2.25	TD90/.625X2.5	TD90/.625X3	TD90/.625X3.5								
3/4"	TD90/.75X2.25	TD90/.75X2.5	TD90/.75X3	TD90/.75X3.5	TD90/.75X4	TD90/.75X4.5		TD90/.75X5.5				
7/8"			TD90/.875X3	TD90/.875X3.5	TD90/.875X4	TD90/.875X4.5		TD90/.875X5.5				
1"			TD90/1X3	TD90/1X3.5	TD90/1X4	TD90/1X4.5		TD90/1X5.5	TD90/1.00X6	TD90/1.00X6.5		
1-1/8"			TD90/1.125X3	TD90/1.125X3.5	TD90/1.125X4	TD90/1.125X4.5		TD90/1.125X5.5				
1-1/4"				TD90/1.25X3.5	TD90/1.25X4	TD90/1.25X4.5	TD90/1.25X5	TD90/1.25X5.5	TD90/1.25X6	TD90/1.25X6.5	TD90/1.25X7	
1-3/8"						TD90/1.375X4.5	TD90/1.375X5	TD90/1.375X5.5	TD90/1.375X6	TD90/1.375X6.5		TD90/1.375X7.5
1-1/2"						TD90/1.5X4.5	TD90/1.5X5	TD90/1.5X5.5	TD90/1.5X6	TD90/1.5X6.5	TD90/1.5X7	TD90/1.5X7.5
1-5/8"								TD90/1.625X5.5	TD90/1.625X6	TD90/1.625X6.5	TD90/1.625X7	TD90/1.625X7.5
1-3/4"								TD90/1.75X5.5	TD90/1.75X6	TD90/1.75X6.5	TD90/1.75X7	TD90/1.75X7.5
1-7/8"									TD90/1.875X6	TD90/1.875X6.5	TD90/1.875X7	TD90/1.875X7.5
2"								TD90/2X5.5	TD90/2X6	TD90/2X6.5	TD90/2X7	TD90/2X7.5
2-1/8"											TD90/2.125X6.5	TD90/2.125X7.5
2-1/4"											TD90/2.25X6.5	TD90/2.25X7.5
2-3/8"											TD90/2.375X6.5	TD90/2.375X7.5
2-1/2"											TD90/2.5X6.5	TD90/2.5X7.5



SQUARE TUBE BENDER DIES

SQUARE TUBE BENDER DIES 180°											
BEND RADIUS	2.25"	3"	3.5"	4"	4.5"	5"	5.5"	6"	6.5"	7"	7.5"
PIPE SIZE											
1/2"		SD180/5X3	SD180/5X3.5	SD180/5X4	SD180/5X4.5		SD180/5X5.5	SD180/5X6	SD180/5X6.5		
5/8"	SD180/875X2.25										
3/4"	SD180/75X2.25	SD180/75X3	SD180/75X3.5	SD180/75X4	SD180/75X4.5		SD180/75X5.5		SD180/75X6.5		
1"		SD180/1X3	SD180/1X3.5	SD180/1X4	SD180/1X4.5	SD180/1X5	SD180/1X5.5	SD180/1X6	SD180/1X6.5		
1-1/4"					SD180/1.25X4.5	SD180/1.25X5	SD180/1.25X5.5	SD180/1.25X6	SD180/1.25X6.5	SD180/1.25X7	
1-1/2"					SD180/1.5X4.5		SD180/1.5X5.5	SD180/1.5X6		SD180/1.5X7	SD180/1.5X7.5
1-3/4"										SD180/1.75X7	
2"										SD180/2X7	SD180/2X7.5

SQUARE TUBE BENDER DIES 90°											
BEND RADIUS	3"	3.5"	4"	4.5"	5"	5.5"	6"	6.5"	7"	7.5"	
PIPE SIZE											
1/2"	SD90/5X3	SD90/5X3.5	SD90/5X4	SD90/5X4.5		SD90/5X5.5	SD90/5X6	SD90/5X6.5			
3/4"	SD90/75X3	SD90/75X3.5	SD90/75X4	SD90/75X4.5		SD90/75X5.5		SD90/75X6.5			
1"	SD90/1X3	SD90/1X3.5	SD90/1X4	SD90/1X4.5	SD90/1X5	SD90/1X5.5	SD90/1X6	SD90/1X6.5			
1-1/4"				SD90/1.25X4.5	SD90/1.25X5	SD90/1.25X5.5	SD90/1.25X6	SD90/1.25X6.5	SD90/1.25X7		
1-1/2"				SD90/1.5X4.5		SD90/1.5X5.5	SD90/1.5X6		SD90/1.5X7	SD90/1.5X7.5	
1-3/4"									SD90/1.75X7		
2"									SD90/2X7	SD90/2X7.5	



BUILD YOUR LEGEND™

MADE IN THE USA, SINCE 1875, our full line of high quality, easy to maintain hydraulic ironworking machinery leads the industry. Ranging from 25 Ton to 120 Ton, single or dual operator models, our Ironworkers are engineered with the highest quality materials and componentry and tailored to your needs.

Enhance your shop's capability by utilizing our flexibility. Whether you need to punch, shear, notch or form we have the solutions that are specific to your shop's individual needs.





BUILD YOUR LEGEND™

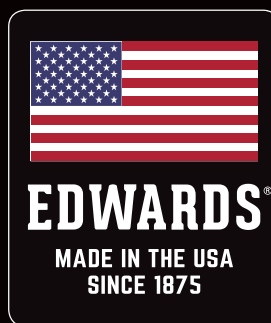

EDWARDSIRONWORKERS.COM
SALES@EDWARDSMFG.US
800.373.8206